

INTRODUCTION - DISCOUNTS, TECH INFO - INSIDE COVER

NEW PRODUCTS - BODY KITS, STUDS, PLUGS, ETC 2-3

HOT PRODUCTS - DOOR STRIKERS, LINE CLAMPS, ETC 4-5

HEADERS, EXHAUST KITS &

TOTAL-LOC BOLTS 6-7

CARB MOUNT KITS 7

ENGINE KITS FOR:

AMC*: 232/258 STRAIGHT SIX & V-8'S 8-9
FORD*: FLAT HEADS V-8S 10
- Y-BLOCKS & MODULAR ENGINES - 16, 24, & 32V 11
- SMALL BLOCKS: 260/289/302/302EFI/351W 12-13
- 351C/351M & 400M 13
- BIG BLOCKS: 352/390/406/410/427/428 FE & 429/460 14

GENERAL MOTORS*

BUICK*: V 6 231 & STRAIGHT 8 15
- BUICK/OLDS/ROVER* 215 & NAILHEADS 16
- 350/400/430/455 V-8 17

CADILLAC*: 331 THRU 500 18

CHEVY*: STRAIGHT SIX'S 194 THRU 292 19

- LS 1/6, 2.8 & 4.3L V 6 20

- SMALL BLOCKS: 265/283/305/307/327/350/400 21-22

- BIG BLOCKS: 348/409 396-454 502-572 23

OLDSMOBILE*: - 260 THRU 455 & ROCKET* 24

PONTIAC*: 287 - EARLY 389 & 350 THRU 455 25

- OVERHEAD CAM 6 CYLINDER 28

INTERNATIONAL*: 304/345/392 25

MOPAR*: SMALL BLOCKS: 273/318/340/360 26

- BIG BLOCKS: 383/413/426/440 26

- EARLY HEMIS* 27

- 426 HEMI* AND LATE MODEL HEMIS* 28

- SLANT SIX 28

VOLKSWAGEN* 72

HARLEY* V-TWINS 74

DRIVELINE KITS:

- TRANSMISSIONS 29-30

- REAR END COVERS 31

BODY & CHASSIS KITS FOR:

AFTERMARKET CHASSIS KITS: 32-33

BUICK* 1970-72 GS 33

CADILLAC* 1955 CONVERTIBLES & SEDANS, 1959 COUPE: 34

CHEVROLET* - 1940-54 35

- 1955-57 FULL SIZE 35-36

- CHEVY* FULL SIZE CARS (1958-68) & (1991-1996) 36-38

- CAMARO* & FIREBIRD* 39-40

- CHEVELLE*/EL CAMINO* & MALIBU* 41-43

- CORVAIR* 43

- CORVETTE* 1953-1976 44-45

- NOVA* & CHEVY II* 46-47

- CHEVY* FULL SIZE PICKUPS 1941-1998 48-54

- CHEVY* S-10, GMC* S-15 & SYCLONE* 55

PONTIAC* - GTO* & LEMANS* 56

FORD* - MODEL 'A' & 1932 ROADSTER 57

- 1939 DELUXE*, 1940 COUPE - THRU 1948 58

- 1949 THRU 1956 59

- FALCON* 1960-65 3

- FAIRLANE* & THUNDERBIRD* 60

- FORD MUSTANG* (1964 1/2 - 70) & (1978-93) 61-62

- FORD* FULL SIZE PICKUPS 1940-1991 63-67

- FORD BRONCO* (1966-77) BRONCO II* & RANGER* 68

- FORD BRONCO* 1978-79 67

JEEP* - CJ* & WRANGLER* 69-70

MOPAR* - 1966-69 B BODY & 1970-74 E BODY 3

NASH* METRO & SUNBEAM* TIGER 71

VOLKSWAGENS* (AIR COOLED) 72-73

HARLEY* - V-TWINS 74-75

ASSORTMENTS

76 & 77

METRIC FASTENERS

- SIX POINT (HIGH STRENGTH) 78

- TWELVE POINT (HIGH STRENGTH) 79

CAP SCREWS (BOLTS)

- BUTTON 80

- FLAT SOCKET 81

- HEX 82-83

- SOCKET 84-85

MACHINE SCREWS

- SET SCREWS, STUDS, ALL THREAD 86

- CARRIAGE & CHEESE HEAD 87

- FLAT HEAD 88

- OVAL HEAD 89

- PAN HEAD 90

NUTS & LOCK NUTS 91-92

WASHERS - LOCK & FLAT 92-93

U.S. FASTENERS

- SIX POINT (HIGH STRENGTH) 94-96

- TWELVE POINT (HIGH STRENGTH) 97-98

- CARRIAGE BOLTS 99

CAP SCREWS (BOLTS)

- BUTTON 100-101

- FLAT SOCKET 102-103

- HEX 104-105

- SOCKET 108-109

MACHINE SCREWS

- BLACK OEM STYLE HARDWARE 106

- INDENTED HEX (OEM) 107

- BINDING HEAD 110

- FILLISTER HEAD 110-111

- FLAT HEAD 112-113

- OVAL HEAD 114-115

- PAN HEAD 116-117

- ROUND HEAD 118-119

- TRUSS HEAD 120-121

- SET SCREWS & STUDS 122-123

- SHOULDER BOLTS 124

- THREADED & PLAIN ROD 124

- U-BOLTS & TALL NUTS 125

NUTS 126-130

LOCK NUTS 131

WASHERS - LOCK & FLAT 132-137

- SPACERS (BUSHINGS) 134-135

SHEET METAL SCREWS

- BUTTON HEAD 101

- FLAT HEAD & DECK SCREWS 138

- HEX & INDENTED HEX 139

- OVAL HEAD & TRIM SCREWS 140

- PAN HEAD 141

- ROUND HEAD 142

- TRUSS HEAD 143

MISC. HARDWARE

- ANTI-SEIZE & THREAD GAUGE - INSIDE
BACK COVER

- BRAKE, FUEL LINE CLAMPS
& TUBING 4

- PIPE FITTINGS 144-145

- PIPE PLUGS & GREASE ZERKS 146

- EXHAUST & HOSE CLAMPS 147

- RIVETS, SNAPS, & LAG BOLTS 148

- COTTER PINS 149

- POLISHING SUPPLIES 150

POINT OF PURCHASE DISPLAYS 151

- ORDER FORM ON PAGE 152 -

*BRAND & MODEL NAMES ARE THE EXCLUSIVE PROPERTY OF THE RESPECTIVE AUTOMAKERS AND ARE USED FOR IDENTIFICATION PURPOSES ONLY!



NEW PRODUCTS - ALL MADE IN USA IN OUR SHOP!

HIGH STRENGTH BUTTON HEADS - AS STRONG OR STRONGER THAN GRADE 8 STEEL



WE CAN TURN THE HEADS AND BROACH HEX DRIVES IN OUR HIGH STRENGTH 6 OR 12 POINT BOLTS TO MAKE BUTTON HEADS.

HIGH STRENGTH 6 AND 12 POINT BOLTS ARE AVAILABLE IN A WIDE RANGE OF SIZES FROM 1/4" THRU 3/4" DIAMETERS (6 THRU 12MM TOO) SEE PAGES 78,79,94-98 FOR SIZE SELECTION.

THE PRICE TO RECUT & BROACH THE HEADS IS:

1/4" (OR 6MM)	ADD \$12 PER BOLT		
5/16", 3/8" (OR 8MM)	13	"	"
7/16 (OR 10MM)	14	"	"
1/2" (OR 12MM)	15	"	"
9/16"	16	"	"
5/8"	17	"	"
3/4"	19	"	"

3/8-24, 7/16-20 & 9/16-12 PICTURED ABOVE - THESE ARE NOT STOCKED - MADE TO ORDER FOR USE IN SHEAR ONLY - BUTTON HEADS ARE NOT TO BE USED IN TENSION

OIL PAN & REAR END PLUGS

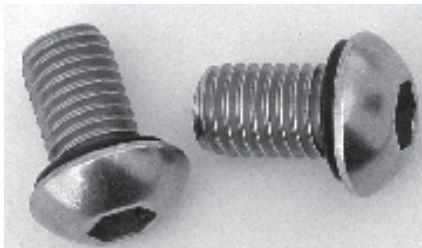

OIL PAN & TRANSMISSION PLUGS: SUPER LOW PROFILE!

1/2-20 TRUSS SOCKET HEAD (3/4" OD FLANGE) # 7-0402	\$ 21.00
12-1.0 MM TRUSS SOCKET HEAD 1-6008	23.00

12 MM OIL PAN PLUGS FOR LS SERIES V-8'S - COMPLETE WITH A QUAD-SEAL O-RING

BUTTON HEAD 1-6004	12.50
SIX POINT - POLISHED 1-6006	19.75
TWELVE POINT - POLISHED 1-6007	19.75

PLUGS FOR DIFFERENTIALS:

5/8-18: (1" OD FLANGE) (FOR SOME 9" FORD DIFFERENTIALS)

BUTTON HEAD 7-0403	24.75
SQUARE FLANGE HEAD 7-0404	33.50

3/4-16: (1 1/8" OD FLANGE) (FOR SOME 9" FORD DIFFERENTIALS)

BUTTON HEAD 7-0405	27.75
SQUARE FLANGE HEAD 7-0406	39.50

7/8-18 (1 " OD FLANGE)

BUTTON HEAD 7-0414	24.75
--------------------	-------

1-20 (1 3/8" OD FLANGE) FOR 1950'S GM CARS & TRUCKS

BUTTON HEAD 7-0401	35.25
SQUARE FLANGE HEAD - ORIGINAL STYLE 7-0400	45.75

16-1.5 MM PLUG

BUTTON HEAD (1" OD HEAD) 7-0413	24.75
---------------------------------	-------

22-1.5 MM PLUGS FOR GM 4X4 TRANSFER CASES

BUTTON HEAD (1 1/4" OD FLANGE) 7-0407	31.50
---------------------------------------	-------

1/2" STRAIGHT PIPE THREAD (1 1/4" OD FLANGE) (FOR '56-'66 BOP)

BUTTON HEAD 7-0409	35.25
SQUARE FLANGE HEAD - ORIGINAL STYLE 7-0410	44.00



NEW BODY KITS! (FOR THE FOLLOWING):

1960-63 FORD FALCON	Convertible	Hard Top / Sedan
CUSTOM STYLE - BUTTON & FLAT SOCKET HEAD	# 9-8000 \$ 375.00	9-8050 \$351.75
ORIGINAL STYLE - INDENTED HEX & PHILLIPS HEAD	9-8002 389.00	9-8052 365.50
ORIGINAL STYLE - INDENTED HEX WITH BLACK STAINLESS	9-8003 410.00	9-8053 385.00
1964-65 FORD FALCON Hard Top / Sedan	1964	1965
CUSTOM STYLE - BUTTON & FLAT SOCKET HEAD	# 9-8103 \$ 322.75	9-8150 \$305.75
ORIGINAL STYLE - INDENTED HEX & PHILLIPS HEAD	9-8105 320.50	9-8152 313.75
ORIGINAL STYLE - INDENTED HEX WITH BLACK STAINLESS	9-8106 360.00	9-8153 359.00
1935-36 FORD PICK UP		
CUSTOM STYLE - BUTTON & FLAT SOCKET HEAD	# 9-4600	\$ 305.00
ORIGINAL STYLE - INDENTED HEX, HEX & PHILLIPS HEAD	9-4601	315.00
1970-74 MOPAR E-BODY (BARRACUDA & DODGE CHALLENGER)		
CUSTOM STYLE - BUTTON & FLAT SOCKET HEAD	# 9-0500	\$ 315.00
ORIGINAL STYLE - INDENTED HEX, HEX & PHILLIPS HEAD	9-0501	345.00
ORIGINAL STYLE - INDENTED HEX WITH BLACK STAINLESS	9-0502	350.00
CHASSIS KIT: FRONT & REAR SUSPENSION - 6 POINT	9-0590	743.75
MOPAR B BODY - SATELLITE, ROAD RUNNER' ETC.	1966-1967	1968-69
CUSTOM STYLE - BUTTON & FLAT SOCKET HEAD	# 9-0700 \$ 304.00	9-0801 \$314.00
ORIGINAL STYLE - INDENTED HEX, HEX & PHILLIPS HEAD	9-0702 343.75	9-0803 353.75

STUD BOLTS:

- ANY COMBINATION OF THREADS
- COARSE, FINE THREAD - OR BOTH
- 3/16 THRU 3/4" DIA. IN 303 (LOW STRENGTH)
- 3/8" THRU 3/4" DIAMETERS ALSO AVAILABLE IN 17-4 PH HEAT TREATED HIGH STRENGTH
- ALSO AVAILABLE WITH FLANGED NUTS

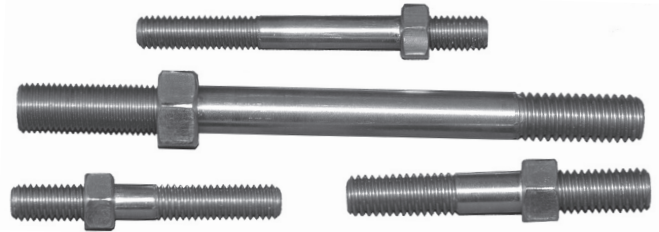

CONVERTIBLE TOP KIT FOR 1967-69 CAMAROS:

208 PIECE KIT FOR REBUILDING YOUR

CONVERTIBLE TOP - SUPPLIED WITH AN ASSEMBLY LIST AND ILLUSTRATION, AVAILABLE IN A CUSTOM STYLE OR ORIGINAL STYLE HARDWARE:

BUTTON & FLAT SOCKET HEAD - CUSTOM	# 6-2828	\$451.50
HEX & PHILLIPS HEAD - ORIGINAL STYLE	6-2827	454.00



SPECIALTY SQUARE NUTS

SIZE	WRENCH	T	PART#	\$
3/8-24	1	5/16	2-4574	15.50
7/16-14	3/4	3/8	2-4578	12.50
7/16-14	7/8	7/16	2-4580	14.50
1/2-13	7/8	7/16	2-4579	14.75

WE CUSTOM MAKE THESE LARGE SQUARE NUTS IN OUR SHOP FROM BAR STOCK

WE HAVE 5/8" THRU 1" SQUARE STOCK

- YOU CAN SPECIFY THREAD TYPE & THICKNESS.

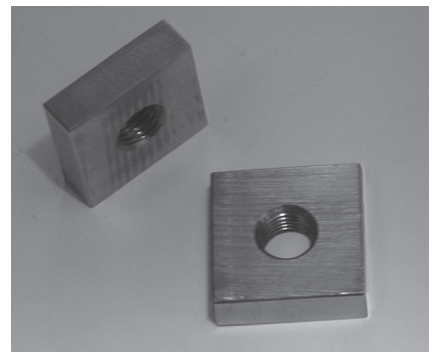

TOLL FREE ORDER LINE : 1-800-767-4781

HOOD HINGE RIVET REPLACEMENT KITS:

NOW YOU CAN GRIND OFF THE RIVETS IN YOUR HOOD HINGES, CHROME, POWDER COAT OR PAINT THE PIECES AND BOLT THEM BACK TOGETHER WITH SPECIAL FLAT TOP SHOULDER BOLTS - WE CAN MAKE THE SHOULDERS LONGER THAN STOCK SO WASHERS CAN BE ADDED TO PREVENT THE PARTS FROM SCRAPING (GREAT FOR PAINTED APPLICATIONS)

KITS FOR: (WE CAN DO THESE FOR NEARLY ANY HINGE - GIVE US A CALL)

LATE 1955 THRU 1958 CHEVY TRUCK (SHOWN AT RIGHT)	6-7767	\$230.25
1964-1/2 THRU 1966 MUSTANG (14 BOLTS WITH NUTS, ETC)	6-4014	330.00
1966-67 NOVA (14 BOLTS WITH NUTS, ETC)	6-7199	323.50

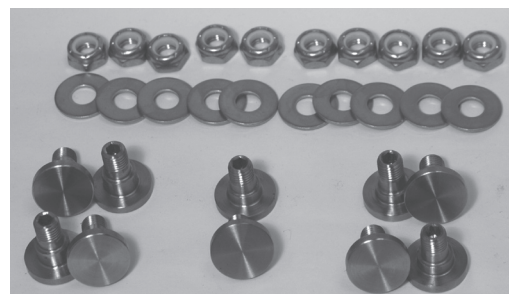

HOT PRODUCTS - ALL MADE IN USA & AUSTRALIA!

BRAKE & FUEL LINE CLAMPS

- MADE IN USA

- ALL CLAMPS MADE FROM 13 GA (.092)
18-8 STAINLESS

- I.D. OF BOLT HOLE IS 13/64" (.204)
* USE #10 SCREWS *

- PARTS ARE FREE FROM BURRS AND
HAVE A BRIGHT FINISH

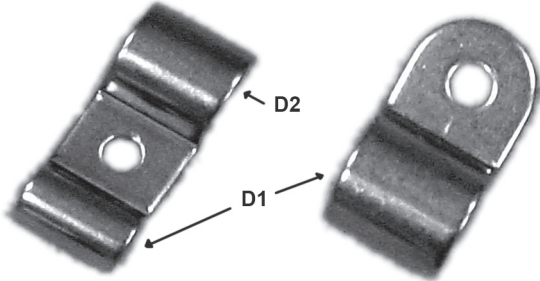

PART#	\$	D1	D2	W	APPLICATION
7-0500	2.75	3/16		.62	BRAKE LINE
7-0501	3.50	1/4		.62	BRAKE LINE
7-0502	3.75	5/16		.66	FUEL/TRANS.
7-0503	4.00	3/8		.66	FUEL LINE
7-0504	4.50	1/2		.72	BATTERY CABLE
- DOUBLE LINE CLAMPS -					
7-0510	4.25	3/16	3/16	.76	BRAKE LINE
7-0511	4.45	3/16	1/4	.76	BRAKE LINE
7-0513	4.55	3/16	3/8	.76	BRAKE/FUEL
7-0514	4.75	1/4	1/4	.76	BRAKE LINE
7-0515	5.25	1/4	3/8	.76	BRAKE/FUEL
7-0518	5.50	5/16	5/16	.76	TRANS./FUEL
7-0516	6.25	5/16	3/8	.76	FUEL LINE
7-0517	6.70	3/8	3/8	.76	FUEL LINE
7-0519	6.75	1/2	1/2	.82	BATTERY CABLE

BACKING PLATES FOR DOUBLE CLAMPS: TAPPED 10-32

FOR 3/16 X 3/16, 3/16 X 1/4 & 1/4 X 1/4 CLAMPS (1 3/8" LONG):	# 7-0536	\$ 6.00
1/4 X 3/8, 5/16 X 5/16, 5/16 X 3/8 & 3/8 X 3/8 (1 5/8" LONG):	7-0537	6.25
FOR 1/2 X 1/2 CLAMPS (1 7/8" LONG):	7-0538	6.50

* NOT BRIGHT FINISH
* MADE TO ORDER IN OUR SHOP

AIR CLEANER NUTS

SIZE	O.D.	PART #	\$
1/4-20	1"	2-4565	15.50
	1 1/4	2-4501	17.00
5/16-18	1"	2-4566	15.50
	1 1/4	2-4503	17.00

NOTE: MOST CARBS
HAVE A 1/4-20 STUD

POLISHED! CUSTOM MADE
IN OUR SHOP

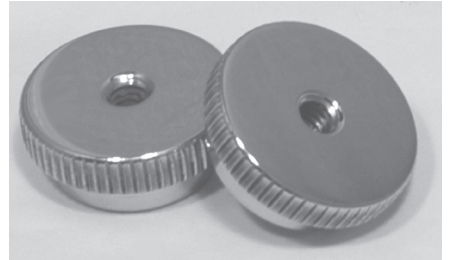

BRAKE LINE CLIPS

- MADE IN AUSTRALIA

- FOR ATTACHING FLEXIBLE
BRAKE LINE TO BRACKETS



2-4500 \$ 3.50



BRACKET FOR CLIP
2-4700 \$ 2.99

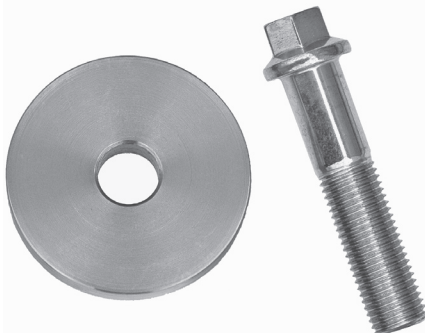

HARMONIC BALANCER KITS

- HIGH STRENGTH (GRADE 8+) STAINLESS BOLTS
- STAINLESS CUSTOM MADE OEM SIZE THICK BILLET WASHERS

AVAILABLE FOR:

AMC V8 & STRAIGHT SIX	- PAGE 9
FORD MODULAR	- PAGE 11
FORD SMALL BLOCK	- PAGE 13
FORD FE BIG BLOCK	- PAGE 14
FORD 429/460	- PAGE 14
215 BUICK/OLDS	- PAGE 16
455 BUICK	- PAGE 17

331-390 CADILLAC	- PAGE 18
SMALL BLOCK CHEVY	- PAGE 22
BIG BLOCK CHEVY	- PAGE 24
INTERNATIONAL V8	- PAGE 26
OLDS 260-455	- PAGE 24
OLDS ROCKET	- PAGE 25
PONTIAC V8	- PAGE 26
EARLY HEMI	- PAGE 29

DOOR STRIKER BOLTS & WASHERS - 17-4 PH HIGH STRENGTH - WEAR RESISTANT PINS WITH CORRECT HEAVY DUTY STAINLESS WASHERS -

**** NOTE #6-8154 & 6-8149 ARE STOCKED ITEMS - ALL OTHER STRIKERS ARE MADE TO ORDER ****



FOR AMX, GREMLIN & JAVELIN (1/2-13 THREAD): 8-8000 \$ 75.00 PER PAIR
 FOR 1967-69 CAMARO, 1964-72 GM A-BODIES, 1965-72 FULL SIZE,
 1968-74 NOVA, 68-82 VETTE & 73 & UP AMC: 6-8154 59.95 PER PAIR
 FOR 1970-92 CAMARO, 1978-87 GM MID & FULL SIZE, 1975-79 NOVA, 1984-93
 S-10 & 1988-98 CHEVY/ GMC C/K TRUCKS & SUV: 6-8149 65.00 PER PAIR
 FOR 1965-66 CORVAIR: 6-8148 85.75 PER PAIR
 FOR 1985-95 CHEVY VAN: 6-8179 85.75 PER PAIR
 FOR 1970-74 DODGE CHALLENGER: 9-0599 95.50 PER PAIR
 FOR 1967-72 FORD PICKUP: 6-6199 95.50 PER PAIR
 FOR 1973-79 FORD PICKUP & 1978-79 BRONCO: 6-6217 95.50 PER PAIR
 FOR 1971-73 MUSTANG: 9-7100 95.25 PER PAIR
 1983-94 MUSTANG: 6-0449 95.50 PER PAIR
 FOR 1982-86 CJ & 87-95 WRANGLER: 6-2098 80.75 PER PAIR
 FOR 1970-74 MOPAR CHALLENGER & BARRACUDA: 9-0599 95.50 PER PAIR

- 1/16 THICK (.05) X 1-1/2 OD SPACER WASHER FOR ALL OF THE ABOVE 2-4973 6.50 EACH
 - 1/8 THICK X 1-1/2 OD SPACER WASHER FOR ALL OF THE ABOVE 2-4427 8.50 EACH

FOR 1973-87 CHEVY/GMC TRUCKS & SUBURBANS, 1973-77 GM MIDSIZE, & 1971-77 FULL SIZE:
 THE SHOULDER OD IS LARGER THAN STOCK TO ELIMINATE THE PLASTIC SHELL - 6-7766 95.50 PER PAIR

- 1/16 THICK (ACTUALLY .05) SPACER WASHER FOR ABOVE (1/2" ID) 2-4994 6.50 EACH
 - 1/8 THICK SPACER WASHER FOR ABOVE 2-4907 8.50 EACH

FOR 'SMALL BEAR CLAW' LATCH: 1/2 X .69 X 3/8-16 THREAD 6-8159 75.50 PER PAIR
 1/2 X .88 X 3/8-16 (EXTRA LONG SHANK) 6-9887 80.75 PER PAIR

FOR 'LARGE BEAR CLAW' LATCHES: 7/16-14 THREAD - MEASURE & SELECT FROM TABLE, WASHERS INCLUDED

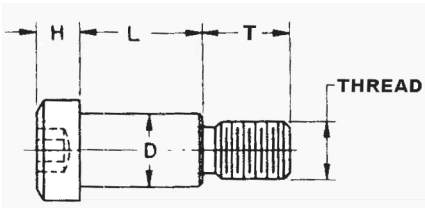

D	L	HEAD O.D.	T	H	WASHER OD	PART #	PRICE
.550	.63	.75	1.5	.16	1.0	6-8175	\$ 92.50
.550	.70	.75	.88	.16	1.17	6-8176	91.50
.550	.81	.75	1.5	.13	1.0	6-8178	97.75
.550	.85	.75	1.0	.13	1.17	6-8184	92.50
.560	.75	.75	1.0	.16	1.17	6-8177	91.50
.625	.75	.75	1.0	.13	1.0	6-8160	91.50
.625	.87	.75	1.0	.18	1.0	6-8187	92.75
.675	.69	.75	.88	.16	1.0	6-8166	92.50
.675	.85	.75	1.0	.18	1.0	6-8173	92.50
.675	1.00	.75	.94	.13	1.0	6-8174	92.75

**** NEED A SPECIAL SIZE? WE CAN MAKE THESE FOR NEARLY ANY APPLICATION - SPECIFY DIMENSIONS SHOWN AND WASHER O.D. ****

SPECIALTY CARRIAGE BOLTS

THE 0.6 X .95 OVAL HEAD BOLTS ARE 7/16-14 ALL OF THE OTHERS ARE 12MM THREADS (USE IN PLACE OF BOLTS WITH 7/16 THREAD -ORDER 12MM NUTS TO MATCH ON PAGE 91. POLISHED TO A MIRROR FINISH MADE TO ORDER IN OUR SHOP!



OVAL HEAD:

0.6 WIDE X .95 LONG (FOR CROSLEY)
 2-7741P \$22.25 EACH
 6-9988 SET OF (4) WITH NUTS & FLATS: 85.50

0.7 WIDE X 1.12 LONG HEAD

1-1802 1-1/4" LONG \$16.50 EACH
 1-1800 1-3/8" LONG 18.75
 1-1805 2" LONG 19.00

5-9999 SET OF (4) 1-3/8" LONG WITH NUTS & FLAT WASHERS: \$73.25

CURVED RECTANGULAR HEAD:

15/16 WIDE X 1 1/16 LONG - FOR 1949-50 MERCURY
 1-1801 \$35.50 EACH
 5-9998 SET OF (4) WITH NUTS & FLATS: \$136.50



- ALL HEADER KITS (EXCEPT STOCK STYLE HEX KITS CONTAIN HIGH STRENGTH BOLTS
- USE 3/4" LENGTH BOLTS FOR HEADER FLANGES 1/4" THICK OR LESS
- USE 1" LENGTH BOLTS FOR HEADER FLANGES OVER 1/4" THICK.
- 1 1/4" AND 1 1/2" LENGTH BOLT KITS ARE FOR CAST IRON MANIFOLDS, CHECK YOUR ORIGINAL BOLT LENGTHS BEFORE ORDERING, SOME EXHAUST MANIFOLDS USED SEVERAL BOLT LENGTHS.

10 COUNT 3/8" HEADER BOLT KITS

-FOR OLDSMOBILE V8, INTERNATIONAL V8

-3/4" LONG BOLTS

SIX POINT - HIGH STRENGTH	# 6-5360	\$ 43.75
TWELVE POINT - HIGH STRENGTH	6-5361	45.50

-7/8" LONG BOLTS - DRILLED FOR SAFETY WIRE *

SIX POINT - HIGH STRENGTH	6-5388	58.00
TWELVE POINT - HIGH STRENGTH	6-5389	60.75

-1" LONG BOLTS

SIX POINT - HIGH STRENGTH	6-5362	45.25
TWELVE POINT - HIGH STRENGTH	6-5363	48.25

11 COUNT 3/8" HEADER BOLT KITS

-FOR AMC STRAIGHT SIX

- 1" LONG BOLTS

SIX POINT - HIGH STRENGTH	6-6611	49.75
TWELVE POINT - HIGH STRENGTH	6-6612	54.00

12 COUNT 5/16" HEADER BOLT KITS

-FOR SMALL BLOCK MOPARS - 12PT ARE LARGE FLANGE

-3/4" LONG BOLTS

SIX POINT - HIGH STRENGTH	6-3038	45.75
TWELVE POINT - HIGH STRENGTH	6-3039	70.25

-7/8" LONG BOLTS - ALL LARGE FLANGE - NOT DRILLED

SIX POINT - HIGH STRENGTH	6-3036	46.75
TWELVE POINT - HIGH STRENGTH	6-3037	49.75

-1" LONG BOLTS

SIX POINT - HIGH STRENGTH	6-3090	51.00
TWELVE POINT - HIGH STRENGTH	6-3210	52.50

12 COUNT 3/8" HEADER BOLT KITS

-FOR AMC V8 (KIND WITH ALL 3/8" BOLTS), BUICK V6, CHEVY 4.3L V6, SMALL BLOCK V8, 37-48 FORD V8, PONTIAC V8, BIG BLOCK MOPAR & OLDS ROCKET V8

-3/4" LONG BOLTS

SIX POINT - HIGH STRENGTH	6-5060	53.25
TWELVE POINT - HIGH STRENGTH	6-5061	55.50

-7/8" LONG BOLTS - DRILLED FOR SAFETY WIRE *

SIX POINT - HIGH STRENGTH	6-5098	69.25
TWELVE POINT - HIGH STRENGTH	6-5099	72.50

-1" LONG BOLTS

SIX POINT - HIGH STRENGTH	6-5062	55.00
TWELVE POINT - HIGH STRENGTH	6-5063	58.75

-1 1/2" LONG BOLTS - STOCK EXHAUST FOR AMC:

HEX HEAD - HAS STOCK APPEARANCE	6-3400	20.00
SIX POINT - HIGH STRENGTH	6-3403	84.75
TWELVE POINT - HIGH STRENGTH	6-3404	88.75

* .032 SAFETY WIRE: 2-9900 \$.35/FT (10 FT MIN)

**SEE NEXT PAGE FOR
COLLECTOR FLANGE KITS**

14 COUNT 3/8" HEADER BOLT KITS

-FOR BUICK V8, 348-409, FORD Y-BLOCK, & EARLY HEMI

-3/4" LONG BOLTS

SIX POINT - HIGH STRENGTH	# 6-0953	\$ 61.75
TWELVE POINT - HIGH STRENGTH	6-0954	64.50

-7/8" LONG BOLTS - DRILLED FOR SAFETY WIRE *

SIX POINT - HIGH STRENGTH	6-0955	80.25
TWELVE POINT - HIGH STRENGTH	6-0956	84.00

-1" LONG BOLTS

SIX POINT - HIGH STRENGTH	6-0957	63.75
TWELVE POINT - HIGH STRENGTH	6-0958	68.25

-1 1/4" LONG BOLTS - FOR STOCK EXHAUST: FORD TRUCK Y-BLOCK (USE 1" FOR T-BIRD) AND EARLY HEMI

HEX HEAD -HAS STOCK APPEARANCE	6-0992	20.75
SIX POINT - HIGH STRENGTH	6-0993	68.50
TWELVE POINT - HIGH STRENGTH	6-0960	72.00
STUDS & HEX NUTS	6-3396	126.00

16 COUNT 3/8" HEADER BOLT KITS

FOR CADILLAC, BIG BLOCK (394 TO 572) CHEVY, 426 HEMI, 215 BUICK/OLDS, BUICK NAILHEAD, FORD 289-351, 351-400 C/M, FE, & 429/490.

-3/4" LONG BOLTS

SIX POINT - HIGH STRENGTH	6-5141	70.25
TWELVE POINT - HIGH STRENGTH	6-5142	73.25

-7/8" LONG BOLTS - DRILLED FOR SAFETY WIRE *

SIX POINT - HIGH STRENGTH	6-5182	91.50
TWELVE POINT - HIGH STRENGTH	6-5183	95.75

-1" LONG BOLTS

SIX POINT - HIGH STRENGTH	6-5143	72.75
TWELVE POINT - HIGH STRENGTH	6-5144	77.75

-1 1/4" LONG BOLTS - STOCK EXHAUST FOR BIG BLOCK CHEVY, FORD 351C, 351/400M.

HEX HEAD - HAS STOCK APPEARANCE	6-5695	23.75
INDENTED HEX WASHER (STOCK FOR BBC)	6-5188	36.50
SIX POINT - HIGH STRENGTH	6-5150	78.00
TWELVE POINT - HIGH STRENGTH	6-5151	82.00

8MM BOLT HEADER KITS

12 COUNT: FOR SOME CHEVY LS ENGINES

SOCKET HEAD - A4-80	5-1537	22.00
SIX POINT - HIGH STRENGTH	5-1538	66.50
TWELVE POINT - HIGH STRENGTH	5-1539	67.50

16 COUNT: FOR SOME CHEVY LS1/6, FORD MOD V8'S & NEW HEMIS

SOCKET HEAD	5-1526	27.00
SIX POINT - HIGH STRENGTH	5-1540	88.00
TWELVE POINT - HIGH STRENGTH	5-1541	89.00

BALL END STUDS WITH 12 POINT NUTS

3/8-16/24 (7/16 WRENCH SIZE)

10 COUNT	6-9995	147.50
11 COUNT	6-9989	161.75
12 COUNT	6-9996	177.00
14 COUNT	6-9997	206.75
16 COUNT	6-9998	235.50

8MM (10 MM WRENCH SIZE)

12 COUNT (FOR SOME LS)	5-1610	235.50
16 COUNT (SOME LS & FORD MODULAR)	5-1611	315.00
17 COUNT (FOR NEW HEMI)	5-1612	334.25
20 COUNT (FOR FORD V-10)	5-1613	393.50

TOLL FREE ORDER LINE : 1-800-767-4781

TOTAL-LOC® LOCKING HEADER BOLTS

TOTAL-LOC® HEADER BOLTS - .53 FLANGE - - VIBRATION PROOF, HEAT RESISTANT, LOCKING HIGH STRENGTH STAINLESS HEADER BOLTS THAT ARE EASY TO USE!

3/8" WRENCH HEAD: SIX POINT - 3/8-16 x 1" - BEST SELLER!

10 COUNT	# 6-5573	\$ 59.75
11 COUNT	6-6971	65.50
12 COUNT	6-5586	71.00
14 COUNT	6-5574	82.50
16 COUNT	6-5599	93.75

TWELVE POINT - 3/8-16 X 1"

10 COUNT	# 6-5581	\$ 59.75
11 COUNT	6-6912	65.50
12 COUNT	6-5582	71.00
14 COUNT	6-5583	81.25
16 COUNT	6-5584	93.75

5/16" WRENCH HEAD: SIX POINT - 3/8-16 x 1" - FOR EXTRA CLEARANCE

10 COUNT	# 6-6950	\$ 59.75
11 COUNT	6-6973	65.50
12 COUNT	6-6951	71.00
14 COUNT	6-6952	82.50
16 COUNT	6-6953	93.75

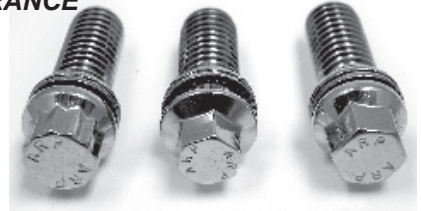

3/8" WRENCH HEAD: SIX POINT - 3/8-16 X 1 1/4"

10 COUNT	# 6-6954	\$ 64.75
11 COUNT	6-6955	71.00
12 COUNT	6-6956	77.25
14 COUNT	6-6957	89.50
16 COUNT	6-6958	102.75

5/16-18 X 1 BOLTS WITH SEPARATE WEDGE LOCKS

TWELVE COUNT (FOR SMALL BLOCK MOPAR)

SIX POINT	# 6-3248	\$ 77.75
TWENTY COUNT (FOR MOPAR V-10)	# 6-3260	\$ 128.50



3/8-16/24 BALL END STUDS, WEDGE LOCK WASHERS, AND 12 POINT NUTS

10 COUNT (SHOWN)	# 6-9990	\$ 167.25
11 COUNT	6-9994	183.00
12 COUNT	6-9991	200.00
14 COUNT	6-9992	232.75
16 COUNT	6-9993	265.75

STUD KIT FOR CUMMINS 6 CYL DIESEL:

10 X 55 MM STUDS, WEDGE LOCK WASHERS, & NUTS

WITH HEX NUTS	# 9-0600	\$ 233.25
WITH 12PT NUTS	9-0601	359.50

8MM BOLTS & SEPARATE WEDGE LOCKS

12 COUNT: (FOR SOME LS ENGINES)

SIX POINT	# 5-1546	\$ 93.50
TWELVE POINT	5-1547	93.75
SOCKET (A4-80)	5-1548	47.50

16 COUNT: (FOR SOME LS & FORD MODULAR)

SIX POINT	# 5-1542	\$ 123.75
TWELVE POINT	5-1543	124.50
SOCKET (A4-80)	5-1544	62.50

17 COUNT: (FOR NEW HEMIS)

SIX POINT	# 5-1590	\$ 131.25
TWELVE POINT	5-1591	135.25
SOCKET (A4-80)	5-1592	65.75

20 COUNT: (FOR FORD V-10)

SIX POINT	# 5-1600	\$ 153.75
TWELVE POINT	5-1601	157.75
SOCKET (A4-80)	5-1602	77.25

8MM BALL END STUDS & WEDGE LOCKS

AND 12 POINT NUTS (10 MM WRENCH SIZE)

12 COUNT (FOR SOME LS)	# 5-1604	\$ 245.00
16 COUNT (FOR SOME LS & FORD MODULAR):		
	5-1605	317.25
17 COUNT (FOR NEW HEMI)	5-1607	336.75
20 COUNT (FOR FORD V-10)	5-1603	392.50

COLLECTOR FLANGE KITS :

3 BOLT TYPE:

INCLUDES SERRATED FLANGE NUTS & SPLIT LOCKS:		
HEX HEAD	# 6-6600	\$ 11.50
SOCKET HEAD	6-6601	12.00
SIX POINT - HIGH STRENGTH	6-6602	32.25
TWELVE POINT - HIGH STRENGTH	6-6603	33.75

4 BOLT TYPE:

# 6-6604	\$ 14.75
6-6605	15.00
6-6606	38.75
6-6607	43.75

COLLECTORS KITS WITH WEDGE LOCK WASHERS:

INCLUDES NUTS & VIBRATION PROOF WEDGE LOCKS (SHOWN HERE):

SIX POINT - HIGH STRENGTH	6-6608	77.50	6-6610	102.25
TWELVE POINT - HIGH STRENGTH	6-6609	79.50	6-6613	104.00



CARB MOUNT KITS (BOLTS TO MANIFOLD)

- FOR HOLLEY, CARTER, ETC. 4 BARREL CARBS

BUTTON HEAD	# 6-5055	\$ 5.00
INDENTED HEX HEAD	6-6399	7.00
HEX HEAD	6-5053	5.50
SOCKET HEAD	6-5054	5.50
SIX POINT - HIGH STRENGTH	6-5178	18.75
TWELVE POINT - HIGH STRENGTH	6-5179	19.25
STUDS & FLANGED NUTS	6-5170	6.75
ARP STUDS & 12 POINT NUTS	6-5275	51.50

- FOR QUADRAJET CARBS

HEX HEAD	# 6-5295	\$ 8.00
SOCKET HEAD	6-5296	9.50
SIX POINT - HIGH STRENGTH	6-5297	25.00
TWELVE POINT - HIGH STRENGTH	6-5294	26.50

- CARB KIT FOR HOLLEY 94 (UP TO 1954) CARBS (27 PIECE ASSEMBLY KIT)

FILLISTER HEAD ORIGINAL STYLE	6-5292	15.50
-------------------------------	--------	-------

FLOAT BOWL KITS FOR HOLLEYS

-FOR FLOAT BOWLS WITHOUT A METERING BLOCK:
-FOR FLOAT BOWLS WITH A METERING BLOCK

SIX POINT - HIGH STRENGTH	# 6-5298	\$ 21.50
SIX POINT - HIGH STRENGTH	6-5299	23.00

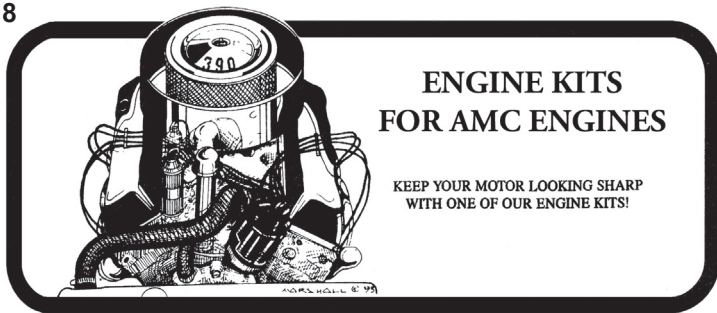

ENGINE KITS FOR AMC ENGINES

KEEP YOUR MOTOR LOOKING SHARP
WITH ONE OF OUR ENGINE KITS!

ENGINE KITS FOR AMC 232-258 STRAIGHT SIX

Each engine kit includes component kits for the Distributor, Fuel Pump, Intake - high strength bolts are used in all intake kits, Oil Pan, Thermostat, Timing Cover, Valve Cover (cast aluminium or sheet metal), and Water Pump. Over 115 pieces and available in 5 different bolt styles!

Contains one of each component kit	Part # for Engines With a Cast Valve Cover:	Part # for Engines with a Sheet Metal Valve Cover:	Price:
232-258 UP THROUGH 1980:			
BUTTON HEAD	# 6-3568	# 6-3500	\$ 97.00
INDENTED HEX (ORIGINAL STYLE)	6-3554	6-3592	108.00
SOCKET HEAD	6-3570	6-3502	102.75
SIX POINT - POLISHED - HIGH STRENGTH	6-3571	6-3503	267.25
TWELVE POINT - POLISHED - HIGH STRENGTH	6-3572	6-3504	286.75
258 1981 THROUGH 1986:			
BUTTON HEAD	# 6-3575	# 6-3580	\$ 95.75
INDENTED HEX (ORIGINAL STYLE)	6-3593	6-3594	108.75
SOCKET HEAD	6-3577	6-3582	100.00
SIX POINT - POLISHED - HIGH STRENGTH	6-3578	6-3583	257.00
TWELVE POINT - POLISHED - HIGH STRENGTH	6-3579	6-3584	278.00
243(4.0L) & 258(4.2L) 1987-1990: 122 PIECES!			
BUTTON HEAD	# 6-3700		\$ 97.00
INDENTED HEX (ORIGINAL STYLE)	6-3702		108.00
SOCKET HEAD	6-3703		103.00
SIX POINT - POLISHED - HIGH STRENGTH	6-3704		280.00
TWELVE POINT - POLISHED - HIGH STRENGTH	6-3705		304.75
243(4.0L) 1991 & UP: 129 PIECES!			
BUTTON HEAD	# 6-3730		\$ 100.00
INDENTED HEX (ORIGINAL STYLE)	6-3732		109.00
SOCKET HEAD	6-3733		106.00
SIX POINT - POLISHED - HIGH STRENGTH	6-3734		314.00
TWELVE POINT - POLISHED - HIGH STRENGTH	6-3735		340.00

** NOTE INDENTED HEX, SIX POINT & TWELVE POINT BOLTS ARE MADE IN USA **

ACCESSORY KITS (NOT INCLUDED IN THE ENGINE KIT)

ALTERNATOR BRACKET FOR CJ'S

BUTTON HEAD	# 6-3555	\$ 9.75
HEX HEAD	6-3550	8.00
SOCKET HEAD	6-3551	10.00
SIX POINT - HIGH STRENGTH	6-3552	28.50
TWELVE POINT - HIGH STRENGTH	6-3553	30.00

BELLHOUSING KITS: T4&5 TRANSMISSIONS

SIX POINT - HIGH STRENGTH	6-3736	80.00
TWELVE POINT - HIGH STRENGTH	6-3737	82.75

COIL BRACKET KITS

BUTTON HEAD	6-3544	4.00
INDENTED HEX - ORIGINAL STYLE	6-3546	5.00
SOCKET HEAD	6-3547	4.00
SIX POINT - HIGH STRENGTH	6-3548	9.75
TWELVE POINT - HIGH STRENGTH	6-3549	10.25

CRANK PULLEY KITS

SIX POINT - HIGH STRENGTH	6-3542	13.75
TWELVE POINT - HIGH STRENGTH	6-3543	14.25

HARMONIC BALANCER KIT FOR SIX CYL.

SIX POINT - HIGH STRENGTH	6-3558	23.75
---------------------------	--------	-------

**EXHAUST BOLT KITS - INCLUDED IN ENGINE
KITS FOR STOCK EXHAUST - FOR HEADERS
SEE 11 COUNT KITS ON PAGES 6-7**

ENGINE MOUNT KIT - (Brackets to the Engine)

FOR SHEET METAL TYPE MOUNTS:		
SIX POINT - HIGH STRENGTH	# 6-3559	\$ 26.25
TWELVE POINT - HIGH STRENGTH	6-3560	28.50
FOR CAST TYPE MOUNTS:		
SIX POINT - HIGH STRENGTH	6-3556	30.00
TWELVE POINT - HIGH STRENGTH	6-3557	31.50

OIL PUMP KITS

SIX POINT - HIGH STRENGTH	6-3746	13.00
TWELVE POINT - HIGH STRENGTH	6-3747	14.00

STARTER KITS

HEX HEAD	6-3744	5.50
SOCKET HEAD	6-3745	7.75
SIX POINT - HIGH STRENGTH	6-3742	15.25
TWELVE POINT - HIGH STRENGTH	6-3743	16.00

TRANSMISSION TO BELLHOUSING: T4&5

SIX POINT - HIGH STRENGTH	6-3738	33.25
TWELVE POINT - HIGH STRENGTH	6-3739	34.25

TRANSFER CASE TO TRANSMISSION: T4&5

SIX POINT - HIGH STRENGTH	6-3740	25.00
TWELVE POINT - HIGH STRENGTH	6-3741	26.00

ENGINE KITS FOR AMC V-8 304- 360- 390- 401

Each engine kit includes component kits for the Distributor, Fuel Pump, Intake, Oil Pan, Thermostat, Timing Cover, Valve Covers (cast aluminium or sheet metal), and Water Pump. Over 145 pieces and available in 5 different bolt styles!

	Part # for Engines with Cast Valve Covers	Part # for Engines with Sheet Metal Valve Covers	Price:
Contains one of each component kit			
BUTTON/SOCKET HEAD	# 6-3464	# 6-3465	\$ 84.50
HEX/INDENTED HEX HEAD (Stock Style)	6-3476	6-3470	86.00
SOCKET HEAD	6-3429	6-3402	94.50
SIX POINT - HIGH STRENGTH - POLISHED	6-3458	6-3466	300.75
TWELVE POINT - HIGH STRENGTH - POLISHED	6-3459	6-3467	342.00

** NOTE INDENTED HEX, SIX POINT & TWELVE POINT BOLTS ARE MADE IN USA **

ACCESSORY KITS (NOT INCLUDED IN THE ENGINE KIT)

BELLOUSING KITS

SIX POINT - HIGH STRENGTH	# 6-3479	\$ 61.25
TWELVE POINT - HIGH STRENGTH	6-3480	62.75

CARB MOUNT KITS - SEE PAGE 7

CRANK PULLEY KITS - 3 BOLT TYPE

SIX POINT - HIGH STRENGTH	6-3542	13.75
TWELVE POINT - HIGH STRENGTH	6-3543	14.25
- 76 & UP ARE 4 BOLT TYPE		
SIX POINT - HIGH STRENGTH	6-3720	17.25
TWELVE POINT - HIGH STRENGTH	6-3719	18.00

EXHAUST BOLT KITS -FOR YEARS WITH ALL 3/8" BOLTS

STOCK EXHAUST- 1.5" LONG BOLTS HEX HEAD (Has stock appearance, but is not as strong as stock)	6-3400	20.00
SIX POINT - HIGH STRENGTH	6-3403	83.00
TWELVE POINT - HIGH STRENGTH	6-3404	87.00

FOR HEADERS SEE 12 COUNT KITS ON PAGES 6 & 7

ENGINE MOUNT KITS

SIX POINT - HIGH STRENGTH	6-3468	27.25
TWELVE POINT - HIGH STRENGTH	6-3469	29.75

HARMONIC BALANCER KIT - V8

SIX POINT - HIGH STRENGTH	6-3482	24.50
---------------------------	--------	-------

OUTSIDE HEAD BOLTS KIT

-7/16" BOLTS:

SIX POINT - HIGH STRENGTH	6-3478	87.50
TWELVE POINT - HIGH STRENGTH	6-3481	92.00

-1/2" BOLTS:

SIX POINT - HIGH STRENGTH	6-3483	118.00
TWELVE POINT - HIGH STRENGTH	6-3484	120.00

POWER STEERING PUMP KITS - KIT WAS

MADE FOR A WAGONEER - MAY WORK FOR OTHER APPLICATIONS

BUTTON HEAD	6-3485	13.50
HEX HEAD	6-3486	13.75
SOCKET HEAD	6-3487	14.25
SIX POINT - HIGH STRENGTH	6-3488	36.50
TWELVE POINT - HIGH STRENGTH	6-3489	37.00

STARTER KITS

BUTTON HEAD	6-3453	5.50
HEX HEAD	6-3454	5.75
SOCKET HEAD	6-3455	6.75
SIX POINT - HIGH STRENGTH	6-3456	12.00
TWELVE POINT - HIGH STRENGTH	6-3457	12.50

STUD BOLT FOR WATER PUMP (5" UNDER HEAD)

6-3/8" OVERALL LENGTH	2-7120	18.00
-----------------------	--------	-------

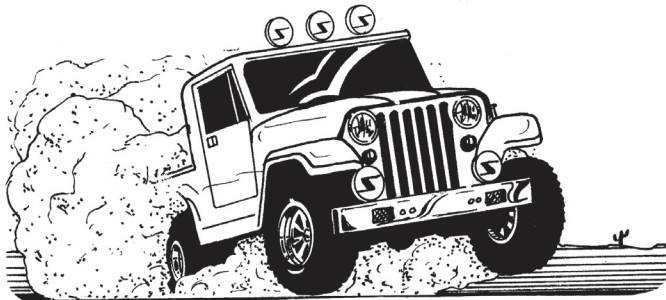

ENGINE KITS FOR MODEL A's

Each engine kit includes component kits for the Bellhousing, Cylinder head nuts, Distributor, Exhaust manifold, Fan & water pump nuts, Generator, Intake, Oil pan, Oil pump return, Starter, Timing cover (with timing plug), Valve cover & Water inlet 203 pieces and available in 5 different bolt styles!

BUTTON HEAD	# 9-2801	\$ 124.50
HEX HEAD (CLOSEST TO ORIGINAL STYLE)	9-2800	122.00
NOTE: ORIGINAL STYLE HIGH HEX HEADS ARE NOT AVAILABLE AT THIS TIME		
SOCKET HEAD	9-2803	134.00
SIX POINT - POLISHED - HIGH STRENGTH	9-2804	351.75
TWELVE POINT - POLISHED - HIGH STRENGTH	9-2805	352.50

See page 57 for body kits!

NOTE TIMING PLUG AND DISTRIBUTOR SCREW ARE INCLUDED IN ENGINE KITS

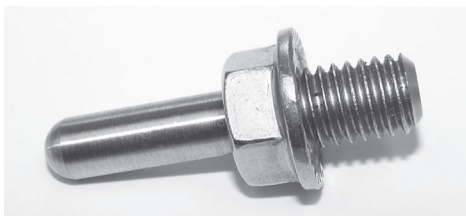

TIMING PLUG: 2-7199 \$20.00



DISTRIBUTOR SCREW & NUT 9-2812 \$13.00

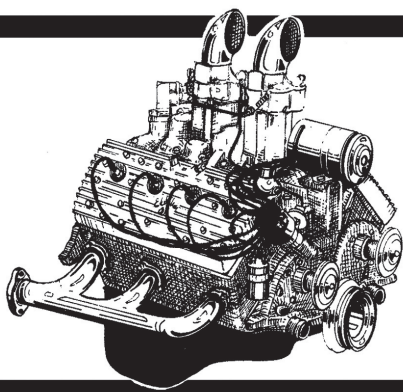

ENGINE KITS FOR FLATHEAD FORD

DRESS UP YOUR VALUABLE
HEAD WITH A SET OF
STAINLESS FASTENERS!

ENGINE KITS FOR 1939-48 FLATHEAD FORD V-8s

ENGINE KITS- Every engine kit includes component kits for the Distributor, Fuel Pump, Intake, Oil Pan, Timing Cover, and Water Pumps. Over 110 pieces and available in 5 different bolt styles!

Contains one of each component kit

		Price
BUTTON HEAD	# 6-0060	\$ 53.75
HEX HEAD (Stock Style)	6-0061	61.50
SOCKET HEAD	6-0062	64.00
SIX POINT - POLISHED - HIGH STRENGTH	6-0063	281.00
TWELVE POINT - POLISHED - HIGH STRENGTH	6-0064	296.00

** NOTE SIX POINT & TWELVE POINT BOLTS ARE MADE IN USA **

ACCESSORY KITS (NOT INCLUDED IN THE ENGINE KIT)

EXHAUST BOLT KITS

STOCK EXHAUST - HIGH STRENGTH		
STUDS & FLANGE NUTS	# 6-0054	\$ 114.75
-FOR HEADERS SEE 12 COUNT KITS - PAGES 6 & 7		

TRANSMISSION MOUNT KIT

SIX POINT - HIGH STRENGTH	6-0096	35.25
TWELVE POINT - HIGH STRENGTH	6-0097	38.50

39-41 GENERATOR MOUNT KIT

HEX NUT, LOCK & FLAT WASHER	6-0098	5.50
-----------------------------	--------	------

39-41 FAN PULLEY KIT

SIX POINT - HIGH STRENGTH	# 6-0099	\$ 17.75
TWELVE POINT - HIGH STRENGTH	6-0059	18.00

HEADBOLT KITS - INCLUDES WASHERS

- FOR STOCK HEADS ONLY		
SIX POINT - HIGH STRENGTH	6-0039	590.75
TWELVE POINT - HIGH STRENGTH	6-0042	594.00
- FOR ALUMINUM "OFFY" HEADS		
SIX POINT - HIGH STRENGTH	6-0014	701.25
TWELVE POINT - HIGH STRENGTH	6-0018	716.75

ENGINE KITS FOR 1949-53 FLATHEAD FORD V-8s

ENGINE KITS- Every engine kit includes component kits for the Distributor, Fan Shaft Bracket, Fuel Pump, Intake, Oil Filter Housing, Oil Pan, Timing Cover, Water Necks, and Water Pumps. Over 115 pieces!

Contains one of each component kit

		Price
ORIGINAL STYLE- HAS INDENTED HEX BOLTS FOR THE OIL PAN, WATER NECKS, AND A STUD KIT FOR THE FUEL PUMP	# 6-0145	\$ 81.25
BUTTON HEAD	6-0100	73.50
HEX HEAD	6-0101	70.50
SOCKET HEAD	6-0102	82.00
SIX POINT - POLISHED - HIGH STRENGTH	6-0103	312.75
TWELVE POINT - POLISHED - HIGH STRENGTH	6-0104	330.75

** NOTE INDENTED HEX, SIX POINT & TWELVE POINT BOLTS ARE MADE IN USA **

ACCESSORY KITS (NOT INCLUDED IN THE ENGINE KIT)

EXHAUST BOLT KITS

-FOR HEADERS		
SIX POINT - HIGH STRENGTH	# 6-0149	\$ 56.00
TWELVE POINT - HIGH STRENGTH	6-0150	59.75
TOTAL-LOCS - SIX POINT	6-6972	91.00
-FOR STOCK EXHAUST		
HEX HEAD	6-0153	20.00

FRONT MOTOR MOUNT KITS

SIX POINT - HIGH STRENGTH	6-0147	35.25
TWELVE POINT - HIGH STRENGTH	6-0148	36.75

HEAD BOLT KITS- FOR STOCK HEADS ONLY
-INCLUDES WASHERS-WE CAN DO PACKAGES FOR AFTER
MARKET HEADS TOO!

SIX POINT - HIGH STRENGTH	# 6-0157	\$ 559.50
TWELVE POINT - HIGH STRENGTH	6-0055	570.75

BELLHOUSING KITS

HEX HEAD	6-0056	15.00
SOCKET HEAD	6-0057	24.00
SIX POINT - HIGH STRENGTH	6-0170	54.75
TWELVE POINT - HIGH STRENGTH	6-0171	55.75

TOLL FREE ORDER LINE : 1-800-767-4781

ENGINE KITS FOR FORD Y-BLOCKS

ENGINE KITS- Every engine kit includes component kits for the Distributor, Fuel Pump, Intake, Oil Pan, Oil Pump Mount, Thermostat, Timing Chain Housing, Valley Cover, Valve Covers, and Water Pump. Over 115 pieces and available in 5 different bolt styles!

Contains one of every component kit

	FOR T-BIRDS:		FOR TRUCKS:		FOR ALL OTHER PASSENGER CARS	
BUTTON/SOCKET HEAD	# 6-9095	\$ 97.50	# 6-0479	\$ 93.75	# 6-0480	\$ 75.00
HEX HEAD	6-9096	85.00	6-0950	81.50	6-0779	72.50
SOCKET HEAD	6-9067	105.00	6-0951	104.00	6-0780	83.50
SIX POINT - POLISHED - HIGH STRENGTH	6-9098	259.50	6-0986	265.50	6-0781	262.50
TWELVE POINT - POLISHED - HIGH STRENGTH	6-9099	290.00	6-0987	303.75	6-0782	289.75

** NOTE SIX POINT & TWELVE POINT BOLTS ARE MADE IN USA **

ACCESSORY KITS (NOT INCLUDED IN THE ENGINE KIT)

CARB MOUNT KITS- SEE PAGE 7

RAMS HORN EXHAUST KITS

STOCK EXHAUST - ALL 1" BOLTS

- (6) 1" & (8) 1 3/4" BOLTS WITH WASHERS

HEX HEAD	# 6-0488	\$ 18.50	HEX HEAD	# 6-0497	\$ 20.00
SIX POINT - HIGH STRENGTH	6-0489	63.75	SIX POINT - HIGH STRENGTH	6-0498	86.75
TWELVE POINT - HIGH STRENGTH	6-0490	69.75	TWELVE POINT - HIGH STRENGTH	6-0499	90.75

- FOR HEADERS SEE 14 COUNT KITS PAGES 6 & 7

ENGINE KITS FOR FORD MODULAR 4.6 L

ENGINE KITS- Every engine kit includes component kits for the AC Compressor, Belt Pulleys, Cam Covers, Cam/Crank Sensors, Intake, Oil Pan, Oil Filter, Power Steering, Timing Cover, and Water Pump.

	Part #	Price:
- KITS FOR SINGLE OVERHEAD CAM 16 VALVE ENGINES:		
BUTTON HEAD	# 5-4700	\$ 146.00
SOCKET HEAD	5-4701	152.00
SIX POINT - POLISHED - HIGH STRENGTH	5-4702	614.00
TWELVE POINT - POLISHED - HIGH STRENGTH	5-4703	655.50
- KITS FOR SINGLE OVERHEAD CAM 24 VALVE ENGINES 236 PIECES:		
BUTTON HEAD	5-4750	151.75
SOCKET HEAD	5-4751	157.00
SIX POINT - POLISHED - HIGH STRENGTH	5-4752	773.75
TWELVE POINT - POLISHED - HIGH STRENGTH	5-4753	804.25
- KITS FOR 1993-95 QUAD CAM ENGINES (WITH STEEL OIL PAN) 267PC:		
BUTTON HEAD	5-4780	127.00
SOCKET HEAD	5-4781	128.75
SIX POINT - POLISHED - HIGH STRENGTH	5-4782	639.75
TWELVE POINT - POLISHED - HIGH STRENGTH	5-4783	713.75
- KITS FOR 1996 & UP QUAD CAM ENGINES (WITH STEEL OIL PAN) 267PC:		
BUTTON HEAD	5-4600	120.00
SOCKET HEAD	5-4601	121.00
SIX POINT - POLISHED - HIGH STRENGTH	5-4602	640.75
TWELVE POINT - POLISHED - HIGH STRENGTH	5-4603	697.00
- KITS FOR SUPERCHARGED QUAD CAM ENGINES (WITH CAST OIL PAN):		
BUTTON HEAD	5-4664	132.00
SOCKET HEAD	5-4665	130.50
SIX POINT - POLISHED - HIGH STRENGTH	5-4666	734.50
TWELVE POINT - POLISHED - HIGH STRENGTH	5-4667	803.75

** NOTE SIX POINT & TWELVE POINT BOLTS ARE MADE IN USA , STUD BOLTS ARE NOT INCLUDED IN KITS **

ACCESSORY KITS (NOT INCLUDED IN THE ENGINE KIT)

BELL HOUSING KIT - WITH 60MM LONG BOLTS

SIX POINT - HIGH STRENGTH	5-4788	62.50
TWELVE POINT - HIGH STRENGTH	5-4789	64.00

HARMONIC BALANCER KIT

SIX POINT - HIGH STRENGTH	5-4778	24.50
TWELVE POINT - HIGH STRENGTH	5-4779	25.50

STARTER KIT

SIX POINT - HIGH STRENGTH	5-4792	19.25
TWELVE POINT - HIGH STRENGTH	5-4793	20.25

STUDS & STUD BOLTS

6 X 48 STUD, NUT & WASHER 93-95	1-1919	7.50
6 X 73 STUD, NUT & WASHER 93-95	1-1921	7.75
8 X 50 STUD BOLT - TIMING COVER	1-1792	17.75
8 X 65 STUD BOLT - TIMING COVER	1-1793	18.00
8 X 78 STUD BOLT 93-95 LOWER INTAKE	1-1933	19.00
8 X 98 STUD BOLT 93-95 LOWER INTAKE	1-1935	20.00

*FOR HEADERS SEE 16 COUNT KITS - PAGES 6 & 7

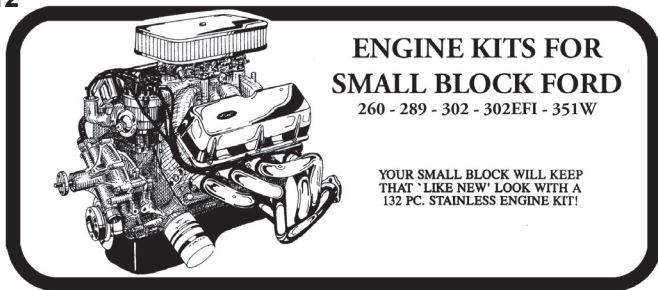

ENGINE KITS- Every engine kit includes component kits for the Distributor, Fuel Pump, Intake, Oil Pan, Thermostat, Timing Chain Housing, Valve Covers, and Water Pump. Over 132 pieces and available in 5 to 6 different bolt styles!

* NOTE INDENTED HEX, SIX POINT & 12 POINT BOLTS ARE MADE IN USA *	FOR ENGINES WITH CAST VALVE COVERS	FOR ENGINES WITH SHEET METAL VALVE COVERS	PRICE:
260 With Raised Water Pump (With Passenger Side Water Pump Inlet)			
BUTTON & SOCKET HEAD	# 6-9050	# 6-9056	\$ 68.75
HEX HEAD	6-9051	6-9057	67.50
HEX/INDENTED HEX (ORIGINAL STYLE)	6-9052	6-9058	79.00
SOCKET HEAD	6-9053	6-9059	65.25
SIX POINT - POLISHED - HIGH STRENGTH	6-9054	6-9060	297.75
TWELVE POINT - POLISHED - HIGH STRENGTH	6-9055	6-9061	327.75
260, 289 & 302 (With Passenger Side Water Pump Inlet)			
BUTTON & SOCKET HEAD	# 6-0886	6-0881	68.00
HEX HEAD	6-0887	6-0925	66.75
HEX/INDENTED HEX (ORIGINAL STYLE)	6-0994	6-0995	78.00
SOCKET HEAD	6-0888	6-0926	74.50
SIX POINT - POLISHED - HIGH STRENGTH	6-0889	6-0927	300.25
TWELVE POINT - POLISHED - HIGH STRENGTH	6-0890	6-0929	328.75
302 (With Driver Side Water Pump Inlet)			
BUTTON & SOCKET HEAD	6-0891	6-0502	67.00
HEX HEAD	6-0892	6-0500	66.75
HEX/INDENTED HEX (ORIGINAL STYLE)	6-0996	6-0997	78.00
SOCKET HEAD	6-0893	6-0501	74.50
SIX POINT - POLISHED - HIGH STRENGTH	6-0894	6-0598	306.50
TWELVE POINT - POLISHED - HIGH STRENGTH	6-0895	6-0599	340.00
302 (5.0L) EFI (Passenger Car up thru 1993 ONLY)			
BUTTON & SOCKET HEAD	6-0896	6-0840	67.75
HEX HEAD	6-0897	6-0841	69.00
SOCKET HEAD	6-0898	6-0842	78.50
SIX POINT - POLISHED - HIGH STRENGTH	6-0935	6-0937	313.00
TWELVE POINT - POLISHED - HIGH STRENGTH	6-0936	6-0938	346.50
302 (5.0L) EFI for 1994 & 1995 MUSTANG ONLY			
BUTTON & SOCKET HEAD	6-9012		68.75
HEX HEAD	6-9013		69.00
SOCKET HEAD	6-9019		77.00
SIX POINT - POLISHED - HIGH STRENGTH	6-9015		319.75
TWELVE POINT - POLISHED - HIGH STRENGTH	6-9016		350.00
351W (With Driver Side Water Pump Inlet)			
BUTTON/SOCKET HEAD	6-0952	6-9023	76.00
HEX HEAD	6-0899	6-0829	73.00
HEX/INDENTED HEX (ORIGINAL STYLE)	6-0998	6-0999	83.00
SOCKET HEAD	6-0866	6-0835	79.00
SIX POINT - POLISHED - HIGH STRENGTH	6-0867	6-0836	318.75
TWELVE POINT - POLISHED - HIGH STRENGTH	6-0870	6-0837	367.00
351W (With Passenger Side Water Pump Inlet)			
BUTTON/SOCKET HEAD	6-9025	6-9024	76.00
HEX HEAD	6-0786	6-0791	70.00
HEX/INDENTED HEX (ORIGINAL STYLE)	6-0787	6-0792	83.00
SOCKET HEAD	6-0788	6-0793	79.00
SIX POINT - POLISHED - HIGH STRENGTH	6-0789	6-0794	328.00
TWELVE POINT - POLISHED - HIGH STRENGTH	6-0790	6-0795	364.00

STUD BOLTS FOR FORDS (NOT INCLUDED IN ENGINE KITS):

STUD BOLT KITS FOR FORD 5.0L WATER PUMPS IN: HIGH STRENGTH - 17-4 PH STAINLESS

1985 MUSTANG WITH (2) SHORT, (2) MEDIUM, (1) LONG STUD BOLT, & FLANGE NUTS (ALSO USED ON SOME FORD TRUCKS & SUV APPLICATIONS)	6-9030	86.00
1986-1993 MUSTANG WITH (2) SHORT & (1) LONG STUD BOLT	6-9029	55.50
1994-1995 MUSTANG WITH (2) SHORT & (1) MEDIUM LENGTH STUD BOLT	6-9028	53.50

TIMING COVER STUD BOLTS: 2" 2-7036 14.95	FOR GROUND STRAP: (3/8-16 X 7/16-14)	2-7133 23.00
2 1/4" 2-7018 14.95		



ACCESSORY KITS FOR SBF (NOT INCLUDED IN THE ENGINE KIT)

ACCESSORY BRACKETS KIT - 1987-93

SIX POINT	# 6-0452	\$ 144.75
TWELVE POINT	6-0453	147.50

BELLHOUSING KIT

-FOR AUTOMATICS WITH 2" BOLTS:

SIX POINT - HIGH STRENGTH	6-0861	54.50
TWELVE POINT - HIGH STRENGTH	6-0912	56.00

-FOR AUTOMATICS (AOD, ETC.) WITH 2 3/16" BOLTS:

SIX POINT - HIGH STRENGTH	5-4598	45.00
TWELVE POINT - HIGH STRENGTH	5-4599	51.00

-FOR MANUAL TRANSMISSION BELL HOUSINGS

WITH 1-1/2" & 2" BOLTS:

HEX HEAD	6-0939	13.75
SOCKET HEAD	6-0940	22.00
SIX POINT - HIGH STRENGTH	6-0941	51.50
TWELVE POINT - HIGH STRENGTH	6-0942	52.00

-FOR 64/66 WITH 1 1/2" LONG BOLTS

SIX POINT - HIGH STRENGTH	6-0826	48.00
TWELVE POINT - HIGH STRENGTH	6-0876	49.75

-FOR TREMEC 5 SPEED

SIX POINT - HIGH STRENGTH	6-0932	56.50
TWELVE POINT - HIGH STRENGTH	6-0933	58.00

CARB MOUNT KITS -SEE PAGE 7

COIL BRACKET KITS

BUTTON HEAD	6-0548	4.75
HEX HEAD	6-0540	4.75
INDENTED HEX HEAD	6-0753	6.00
SOCKET HEAD	6-0541	4.75
SIX POINT - HIGH STRENGTH	6-0913	10.75
TWELVE POINT - HIGH STRENGTH	6-0934	11.00

CRANK PULLEY KITS

SIX POINT - HIGH STRENGTH	6-0576	19.25
TWELVE POINT - HIGH STRENGTH	6-0577	20.50

FAN PULLEY KITS - SEE LISTING ON NEXT PAGE

ENGINE MOUNT KITS

SIX POINT - HIGH STRENGTH	# 6-0833	\$ 23.00
TWELVE POINT - HIGH STRENGTH	6-0834	24.00

EXHAUST BOLT KITS

-STOCK EXHAUST: (8) 1 1/4" & (8) 2" BOLTS

HEX HEAD - STOCK TYPE APPEARANCE BUT NOT AS STRONG AS STOCK	6-0877	26.75
SIX POINT - HIGH STRENGTH	6-0827	100.75
TWELVE POINT - HIGH STRENGTH	6-0828	106.50

-FOR HEADERS SEE 16 COUNT KIT- PAGES 6 & 7

HARMONIC BALANCER KIT

SIX POINT - HIGH STRENGTH	6-0725	47.00
---------------------------	--------	-------

OUTSIDE HEADBOLT KITS (Except 351)

SIX POINT - HIGH STRENGTH	6-0796	86.25
TWELVE POINT - HIGH STRENGTH	6-9017	108.00

- FOR 351W WITH 3" LONG OUTER BOLTS:

SIX POINT - HIGH STRENGTH	6-0454	126.50
TWELVE POINT - HIGH STRENGTH	6-0455	128.50

HEAD BOLT WASHERS FOR ALUMINUM HEADS

OUTSIDE SET (10) FOR: 260/289/302	6-0456	23.50
OUTSIDE SET FOR 351W:	6-9026	52.00

7/16-14 HEADBOLT WITH 3/8-16 X 1 1/2" STUD

	6-7052	23.00
--	--------	-------

STARTER KITS

BUTTON HEAD	6-0580	4.50
HEX HEAD	6-0533	4.75
SOCKET HEAD	6-0534	5.00
SIX POINT - HIGH STRENGTH	6-0800	11.50
TWELVE POINT - HIGH STRENGTH	6-0801	12.50

TRANSMISSION KITS -SEE PAGE 30

KITS FOR 351C/351M/400M FORD ENGINES

ENGINE KITS- Every engine kit includes component kits for the Distributor, Fuel Pump, Intake, Oil Pan, Thermostat, Timing Chain Housing, Valve Covers, and Water Pump. Over 115 pieces and available in 6 different bolt styles! ** NOTE INDENTED HEX, SIX POINT & TWELVE POINT BOLTS ARE MADE IN USA **

FOR ENGINES WITH:

CAST VALVE COVERS

SHEET METAL VALVE COVERS

Price:

351C - FOR ENGINES WITH (4) 1 3/4" & (4) 2 1/4" LONG INTAKE BOLTS PLUS THE 5/16" BOLTS

BUTTON & SOCKET HEAD	# 6-0673	# 6-0678	\$ 60.50
HEX HEAD	6-0674	6-0679	64.50
HEX/INDENTED HEX HEAD (ORIGINAL STYLE)	6-0770	6-0771	74.50
SOCKET HEAD	6-0675	6-0680	67.75
SIX POINT - POLISHED - HIGH STRENGTH	6-0676	6-0681	318.75
TWELVE POINT - POLISHED - HIGH STRENGTH	6-0677	6-0682	342.00

351C/M & 400M - FOR ENGINES WITH (8) 2 1/4" LONG INTAKE BOLTS PLUS THE 5/16" BOLTS

BUTTON & SOCKET HEAD	# 6-0683	# 6-0550	\$ 57.50
HEX HEAD	6-0684	6-0551	61.50
HEX/INDENTED HEX HEAD (ORIGINAL STYLE)	6-0772	6-0773	73.50
SOCKET HEAD	6-0685	6-0552	64.50
SIX POINT - POLISHED - HIGH STRENGTH	6-0686	6-0819	318.00
TWELVE POINT - POLISHED - HIGH STRENGTH	6-0687	6-0820	345.75

ACCESSORY KITS (NOT INCLUDED IN THE ENGINE KIT)

BELLHOUSING KIT - WITH 1 1/2" BOLTS

SIX POINT - HIGH STRENGTH	# 6-0826	\$ 49.00
TWELVE POINT - HIGH STRENGTH	6-0876	50.75

CRANK PULLEY KITS

SIX POINT - HIGH STRENGTH	6-0576	20.25
TWELVE POINT - HIGH STRENGTH	6-0577	21.50

EXHAUST BOLT KITS - SEE 16 COUNT KITS ON PAGES 6 & 7

ENGINE MOUNT KITS

SIX POINT - HIGH STRENGTH	#6-0798	\$33.25
TWELVE POINT - HIGH STRENGTH	6-0799	34.00

STARTER KITS

BUTTON HEAD	6-0570	4.50
HEX HEAD	6-0571	4.75
SOCKET HEAD	6-0582	5.00
SIX POINT - HIGH STRENGTH	6-0817	11.25
TWELVE POINT - HIGH STRENGTH	6-0818	12.00

14 KITS FOR FE (352-390-406-410-427-428) FORD ENGINES

ENGINE KITS- Every engine kit includes component kits for the Distributor, Fuel Pump, Intake, Oil Filter, Oil Pan, Thermostat Housing, Timing Chain Housing, Valve Covers, and Water Pump. Over 115 pieces and available in 6 different bolt styles! ** NOTE INDENTED HEX, SIX POINT & TWELVE POINT BOLTS ARE MADE IN USA **

	FOR ENGINES WITH CAST VALVE COVERS	FOR ENGINES WITH SHEET METAL VALVE COVERS	PRICE:
BUTTON HEAD	# 6-0690	# 6-0600	\$ 56.75
HEX HEAD	6-0691	6-0601	63.50
HEX & INDENTED HEX HEAD (ORIGINAL STYLE) - HAS INDENTED HEX BOLTS FOR FUEL PUMP, OIL FILTER, OIL PAN, TIMING COVER, THERMOSTAT & VALVE COVERS	6-0699	6-0663	68.75
SOCKET HEAD	6-0692	6-0602	64.50
SIX POINT - POLISHED - HIGH STRENGTH	6-0693	6-0632	292.25
TWELVE POINT - POLISHED - HIGH STRENGTH	6-0694	6-0633	309.75

ACCESSORY KITS (NOT INCLUDED IN THE ENGINE KIT)

BELLHOUSING KIT

- FOR AUTOMATIC WITH 2 1/4" BOLTS:

SIX POINT - HIGH STRENGTH	# 6-0861	\$ 54.50
TWELVE POINT - HIGH STRENGTH	6-0625	59.25

- FOR C6 AUTOMATICS & MANUALS: WITH 1 1/2" BOLTS

SIX POINT - HIGH STRENGTH	6-0826	48.50
TWELVE POINT - HIGH STRENGTH	6-0876	49.75

CARB MOUNT KITS - SEE PAGE 7

CRANK PULLEY

SIX POINT - HIGH STRENGTH	6-0631	14.50
TWELVE POINT - HIGH STRENGTH	6-0627	15.25

ENGINE MOUNT KITS

SIX POINT - HIGH STRENGTH	6-0667	43.50
TWELVE POINT - HIGH STRENGTH	6-0664	46.00

PLUG WIRE HOLDER STUD BOLTS:

1/4-20 X 9/16 - 2-9/16 OVERALL LENGTH	2-7002	\$ 13.00
1/4-20 X 13/16 - 2-1/4 OVERALL LENGTH	2-7003	13.50
1/4-20 X 1 - 3" OVERALL LENGTH	2-7004	14.50

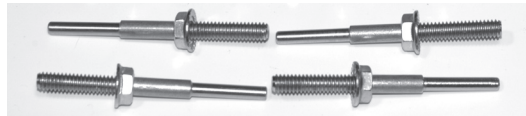

EXHAUST BOLT KITS

- HEADERS: SEE 16 COUNT KITS ON PAGES 6 & 7

- STOCK EXHAUST: 1 1/2" LONG BOLTS:

HEX HEAD	# 6-0878	\$ 19.00
SIX POINT - HIGH STRENGTH	6-0812	105.00
TWELVE POINT - HIGH STRENGTH	6-0813	110.25

HARMONIC BALANCER KIT - 2" BOLT

SIX POINT - HIGH STRENGTH	6-0630	51.00
---------------------------	--------	-------

STARTER KITS

BUTTON HEAD	6-0653	5.00
HEX HEAD	6-0623	5.25
SOCKET HEAD	6-0624	5.50
SIX POINT - HIGH STRENGTH	6-0655	16.50
TWELVE POINT - HIGH STRENGTH	6-0656	16.75

KITS FOR 429-460 FORD ENGINES

ENGINE KITS- Every engine kit includes component kits for the Distributor, Fuel Pump, Intake, Oil Pan, Thermostat, Front Cover, Valve Covers, and Water Pump. Over 115 pieces and available in 6 different bolt styles! ** NOTE INDENTED HEX, SIX POINT & TWELVE POINT BOLTS ARE MADE IN USA **

	FOR ENGINES WITH CAST VALVE COVERS	FOR ENGINES WITH SHEET METAL VALVE COVERS	PRICE
BUTTON HEAD	# 6-6320	# 6-6325	\$ 71.50
HEX HEAD	6-6321	6-6326	73.75
INDENTED HEX/HEX HEAD (ORIGINAL STYLE)	6-6305	6-6306	77.50
SOCKET HEAD	6-6322	6-6327	94.00
SIX POINT - POLISHED - HIGH STRENGTH	6-6323	6-6328	378.50
TWELVE POINT - POLISHED - HIGH STRENGTH	6-6324	6-6329	410.75

ACCESSORY KITS (NOT INCLUDED IN THE ENGINE KITS)

BELLHOUSING KITS - WITH 1 1/2" BOLTS

SIX POINT - HIGH STRENGTH	# 6-0826	\$ 48.50
TWELVE POINT - HIGH STRENGTH	6-0876	49.75

CARB MOUNT KITS - SEE PAGE 7

CRANK PULLEY KITS

SIX POINT - HIGH STRENGTH	6-0714	18.50
TWELVE POINT - HIGH STRENGTH	6-0715	20.25

FAN PULLEY KITS- 3/4" LONG BOLTS

-STEEL PULLEYS WITHOUT A SPACER:

SIX POINT - HIGH STRENGTH	6-5609	17.50
TWELVE POINT - HIGH STRENGTH	6-5607	18.25

-ALUMINUM PULLEYS: WITH COUNTERSUNK HOLES
AND NO FAN BLADE

FLAT SOCKET	6-5608	5.50
-------------	--------	------

EXHAUST BOLT KITS

- SEE 16 COUNT BOLT KITS ON PAGES 6 & 7

ENGINE MOUNT KITS

SIX POINT - HIGH STRENGTH	# 6-0667	\$ 43.75
TWELVE POINT - HIGH STRENGTH	6-0664	46.00

STARTER KITS

BUTTON HEAD	6-0745	4.50
HEX HEAD	6-0750	4.75
SOCKET HEAD	6-0751	5.00
SIX POINT - HIGH STRENGTH	6-0746	11.50
TWELVE POINT - HIGH STRENGTH	6-0747	12.50

HARMONIC BALANCER KIT - 1-3/4" BOLT

SIX POINT - HIGH STRENGTH	6-6319	52.00
---------------------------	--------	-------

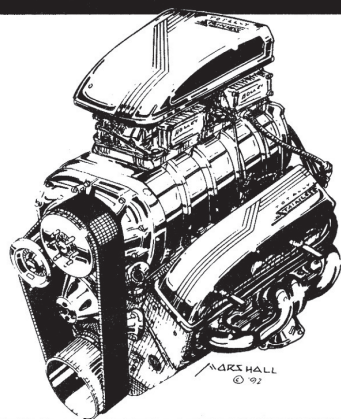

ENGINE KITS FOR GENERAL MOTORS BUICK - CADILLAC - CHEVROLET OLDSMOBILE - PONTIAC

KITS FOR BUICK 231 V6 ENGINES

ENGINE KITS- Every engine kit includes component kits for the Distributor, Front Cover/Water Pump, Fuel Pump (Non-Turbo), Intake, Oil Pan, Thermostat Housing, Timing Cover, and Valve Covers. Turbo Kits also Include kits for the Coil Pack/Bracket, Fuel Rail, Throttle Body & Plenum. Over 115 pieces and available in 5 to 6 different bolt styles!

	FOR ENGINES WITH CAST VALVE COVERS	FOR ENGINES WITH SHEET METAL VALVE COVERS	PRICE
CARBURATED ENGINES			
BUTTON & SOCKET HEAD	# 6-5927	# 6-5900	\$ 67.00
HEX HEAD	6-5928	6-5901	60.50
HEX/INDENTED HEX HEAD (ORIGINAL STYLE)	6-5992	6-5993	71.25
SOCKET HEAD	6-5929	6-5902	75.75
SIX POINT - POLISHED - HIGH STRENGTH	6-5937	6-5938	262.00
TWELVE POINT - POLISHED - HIGH STRENGTH	6-5940	6-5941	265.75

	FOR ENGINES WITH CAST VALVE COVERS	PRICE	FOR ENGINES WITH VALVE COVER WITH STUDS	PRICE
TURBO CHARGED ENGINES				
BUTTON & SOCKET HEAD	6-5987	95.75	6-5774	104.50
HEX HEAD	6-5988	88.00	6-5775	84.50
SOCKET HEAD	6-5989	92.50	6-5776	103.00
SIX POINT - POLISHED - HIGH STRENGTH	6-5990	348.25	6-5777	329.75
TWELVE POINT - POLISHED - HIGH STRENGTH	6-5867	447.00	6-5778	408.75

** NOTE INDENTED HEX, SIX POINT & TWELVE POINT BOLTS ARE MADE IN USA **

ACCESSORY KITS (NOT INCLUDED IN THE ENGINE KITS)

BELLHOUSING KITS - SEE PAGE 29

CARB MOUNT KITS -SEE PAGE 7

EXHAUST BOLT KITS

-HEADERS SEE 12 COUNT KITS- PAGES 6 & 7

-STOCK EXHAUST

SIX POINT - HIGH STRENGTH	# 6-5905	\$ 86.25
TWELVE POINT - HIGH STRENGTH	6-5906	89.25
-TURBO V6		
SIX POINT - HIGH STRENGTH	6-5920	65.25
TWELVE POINT - HIGH STRENGTH	6-5862	68.75

ENGINE MOUNTS KIT

SIX POINT	6-5798	26.00
TWELVE POINT	6-5799	27.75

FAN PULLEY KIT- 3/4" LONG BOLTS

- FOR STEEL PULLEYS WITHOUT A SPACER:

SIX POINT - HIGH STRENGTH	# 6-5609	\$ 17.50
TWELVE POINT - HIGH STRENGTH	6-5607	18.25

- FOR ALUMINUM PULLEYS: WITH COUNTERSUNK HOLES

FLAT SOCKET	6-5608	5.25
-------------	--------	------

CRANK PULLEY KIT

SIX POINT - HIGH STRENGTH	6-5796	23.25
TWELVE POINT - HIGH STRENGTH	6-5797	25.00

ACCESSORY BELT DRIVE KIT FOR TURBO V6

1986:

SIX POINT & SERRATED FLANGE NUTS	6-5772	152.50
TWELVE POINT & SERRATED FLANGE NUTS	6-5773	158.75

1987:

SIX POINT & SERRATED FLANGE NUTS	6-5788	130.75
TWELVE POINT & SERRATED FLANGE NUTS	6-5789	152.50

ENGINE KIT FOR BUICK STRAIGHT 8

- INCLUDES STUDS & HEAVY DUTY WASHERS FOR INTAKE/EXHAUST

BUTTON HEAD	6-2550	177.00
HEX HEAD	6-2551	170.25
SOCKET HEAD	6-2553	185.00
SIX POINT - POLISHED	6-2554	359.00
TWELVE POINT - POLISHED	6-2555	379.00

16 KITS FOR 215 BUICK/OLDS/ROVER ENGINES

ENGINE KITS- Every engine kit includes component kits for the Distributor, Fuel Pump, Intake, Oil Filter, Oil Pan, Thermostat Housing, Timing Cover, Valve Covers, and Water Pump. Over 115 pieces and available in 6 different bolt styles! ** NOTE INDENTED HEX, SIX POINT & TWELVE POINT BOLTS ARE MADE IN USA **

	FOR ENGINES WITH CAST VALVE COVERS	FOR ENGINES WITH SHEET METAL VALVE COVERS	PRICE:
BUTTON/SOCKET HEAD	# 6-4820	# 6-4825	\$ 81.50
HEX HEAD	6-4800	6-4826	84.50
HEX/INDENTED HEX (ORIGINAL STYLE)	6-4821	6-4827	91.50
SOCKET HEAD	6-4822	6-4828	88.50
SIX POINT - POLISHED - HIGH STRENGTH	6-4823	6-4829	321.75
TWELVE POINT - POLISHED - HIGH STRENGTH	6-4824	6-4830	347.25

ACCESSORY KITS (NOT INCLUDED IN THE ENGINE KITS)

BELLHOUSING KITS- SEE PAGE 29 -NOTE:
USE THE 1 1/2" LONG KIT FOR AUTOMATICS

FOR 5 SPEED ROVER:

SIX POINT - HIGH STRENGTH # 6-6400 \$ 63.25

ENGINE MOUNT KITS

SIX POINT - HIGH STRENGTH 6-4842 24.50
TWELVE POINT - HIGH STRENGTH 6-4848 25.50

FAN PULLEY KITS- 3/4" LONG BOLTS

-STEEL PULLEYS WITHOUT A SPACER:

SIX POINT - HIGH STRENGTH 6-5609 17.50
TWELVE POINT - HIGH STRENGTH 6-5607 18.25

**-ALUMINUM PULLEYS: WITH COUNTERSUNK HOLES
AND NO FAN BLADE**

FLAT SOCKET 6-5608 5.25

CARB MOUNT KITS - SEE PAGE 7

HARMONIC BALANCER KIT

SIX POINT - HIGH STRENGTH # 6-4889 \$ 47.00

EXHAUST BOLT KITS

-HEADERS: SEE 16 COUNT BOLT KITS PAGES 6 & 7

-STOCK EXHAUST:

HEX HEAD 6-4810 16.00
SIX POINT - HIGH STRENGTH 6-4831 69.00
TWELVE POINT - HIGH STRENGTH 6-4837 75.00

STARTER KITS

HEX HEAD 6-4809 5.00
SOCKET HEAD 6-4853 5.25
SIX POINT - HIGH STRENGTH 6-4858 12.25
TWELVE POINT - HIGH STRENGTH 6-4862 13.00

KITS FOR BUICK NAILHEAD ENGINES

ENGINE KITS- Every engine kit includes component kits for the Distributor, Fuel Pump, Intake Manifold, Oil Filter, Oil Pan, Thermostat Housing, Timing Cover, Valley Cover, Valve Covers, and Water Pump. Over 115 pieces and available in 6 different bolt styles!

* NOTE INDENTED HEX, SIX POINT &
12 POINT BOLTS ARE MADE IN USA *

	FOR ENGINES WITH CAST VALVE COVERS	FOR ENGINES WITH SHEET METAL VALVE COVERS	PRICE:
BUTTON/SOCKET HEAD	# 6-4900	# 6-4907	\$ 70.00
HEX HEAD	6-4901	6-4908	84.00
HEX/INDENTED HEX (ORIGINAL STYLE)	6-4902	6-4909	91.50
SOCKET HEAD	6-4903	6-4910	90.00
SIX POINT - POLISHED - HIGH STRENGTH	6-4904	6-4911	324.25
TWELVE POINT - POLISHED - HIGH STRENGTH	6-4905	6-4912	349.50

ACCESSORY KITS (NOT INCLUDED IN THE ENGINE KITS)

BELLHOUSING KITS

SIX POINT - HIGH STRENGTH # 6-4976 \$ 50.75
TWELVE POINT - HIGH STRENGTH 6-4977 53.25

CAST PLUG WIRE COVERS

BUTTON HEAD 6-4963 7.00
HEX HEAD 6-4964 7.25
SOCKET HEAD 6-4965 7.50
SIX POINT - HIGH STRENGTH 6-4966 31.00
TWELVE POINT - HIGH STRENGTH 6-4967 32.50

CRANK PULLEY KITS

SIX POINT - HIGH STRENGTH 6-4968 25.75
TWELVE POINT - HIGH STRENGTH 6-4969 26.25

ENGINE MOUNT KITS

SIX POINT - HIGH STRENGTH 6-4970 32.25
TWELVE POINT - HIGH STRENGTH 6-4971 34.25

EXHAUST STUD - SPECIAL STEPPED STUDS:

7/16-14 X 1/2-13 X 1 7/8" LONG
SET OF 4 STUDS - HIGH STRENGTH 6-4990 70.50

CARB MOUNT KITS- SEE PAGE 7

EXHAUST BOLT KITS

-HEADERS: SEE 16 COUNT BOLT KITS PAGES 6 & 7

-STOCK EXHAUST:

HEX HEAD 6-4973 \$ 22.00
SOCKET HEAD 6-4975 24.00
SIX POINT - HIGH STRENGTH 6-4972 80.75
TWELVE POINT - HIGH STRENGTH 6-4974 84.75

OUTSIDE HEAD BOLT KITS

SIX POINT - HIGH STRENGTH 6-4978 190.00
TWELVE POINT - HIGH STRENGTH 6-4988 215.75
HEADBOLT WITH 7/16-20 X 1 3/8 STUD 2-7057 24.75

STARTER KITS

HEX HEAD 6-4984 6.00
SOCKET HEAD 6-4985 6.50
SIX POINT - HIGH STRENGTH 6-4986 13.00
TWELVE POINT - HIGH STRENGTH 6-4987 14.50

WATER CROSSOVER STUD BOLT

3/8-16 X2 UNDER HEAD, 3/4" STUD ON TOP 2-7022 15.25

KITS FOR 350 - 400 - 430 - 455 BUICK V8 ENGINES ¹⁷

ENGINE KITS- Every engine kit includes component kits for the Distributor, Fuel Pump, Intake, Oil Pan, Thermostat, Timing Cover, Valve Covers, and Water Pump. Available in 6 different bolt styles!

* NOTE INDENTED HEX, SIX POINT & 12 POINT BOLTS ARE MADE IN USA *

FOR ENGINES WITH CAST VALVE COVERS

FOR ENGINES WITH SHEET METAL VALVE COVERS

PRICE:

350

BUTTON & SOCKET HEAD	# 6-5896	# 6-5800	\$ 65.75
HEX HEAD	6-5897	6-5801	66.75
HEX/INDENTED HEX HEAD (ORIGINAL STYLE)	6-5974	6-5975	72.00
SOCKET HEAD	6-5898	6-5802	71.00
SIX POINT - POLISHED - HIGH STRENGTH	6-5944	6-5945	290.00
TWELVE POINT - POLISHED - HIGH STRENGTH	6-5946	6-5947	312.25

400 - 430

BUTTON & SOCKET HEAD	6-5930	6-5886	65.00
HEX HEAD	6-5931	6-5887	66.00
HEX/INDENTED HEX HEAD (ORIGINAL STYLE)	6-5889	6-5969	74.25
SOCKET HEAD	6-5932	6-5888	71.50
SIX POINT - POLISHED - HIGH STRENGTH	6-5950	6-5951	296.75
TWELVE POINT - POLISHED - HIGH STRENGTH	6-5952	6-5953	319.50

455

BUTTON & SOCKET HEAD	6-5933	6-5850	76.00
HEX HEAD	6-5934	6-5851	65.00
HEX/INDENTED HEX HEAD (ORIGINAL STYLE)	6-5890	6-5967	71.75
SOCKET HEAD	6-5935	6-5852	82.50
SIX POINT - POLISHED - HIGH STRENGTH	6-5954	6-5955	317.50
TWELVE POINT - POLISHED - HIGH STRENGTH	6-5956	6-5957	333.00

ACCESSORY KITS (NOT INCLUDED IN THE ENGINE KIT)

BELLHOUSING KITS- SEE PAGE 29

CARB MOUNT KITS- SEE PAGE 7

CRANK PULLEY KITS

SIX POINT - HIGH STRENGTH	# 6-5884	\$ 23.25
TWELVE POINT - HIGH STRENGTH	6-5885	24.50

ENGINE MOUNT KITS

SIX POINT - HIGH STRENGTH	6-5841	23.25
TWELVE POINT - HIGH STRENGTH	6-5842	24.25

FAN PULLEY KITS- 3/4" LONG BOLTS

-STEEL PULLEYS WITHOUT A SPACER:

SIX POINT - HIGH STRENGTH	6-5609	17.50
TWELVE POINT - HIGH STRENGTH	6-5607	18.25

-ALUMINUM PULLEYS: WITH COUNTERSUNK HOLES AND NO FAN BLADE

FLAT SOCKET	6-5608	5.25
-------------	--------	------

HARMONIC BALANCER KIT

- FOR 455

SIX POINT - HIGH STRENGTH	6-9695	64.50
---------------------------	--------	-------

EXHAUST BOLT KITS

-FOR HEADERS SEE 14 COUNT KITS ON PAGES 6 & 7

-FOR 350 GS STOCK EXHAUST:

HEX HEAD	# 6-5960	\$ 28.00
----------	----------	----------

-FOR 400-455 GS STOCK EXHAUST:

HEX HEAD	6-5899	25.00
SIX POINT - HIGH STRENGTH	6-5904	92.00

HEAD BOLT KITS FOR 455-V8

COMPLETE SET (OUTSIDE & INSIDE)

SIX POINT - HIGH STRENGTH	6-9698	261.50
TWELVE POINT - HIGH STRENGTH	6-9699	262.00

OUTSIDE BOLTS ONLY

SIX POINT - HIGH STRENGTH	6-9696	122.75
TWELVE POINT - HIGH STRENGTH	6-9697	123.00

HEAD BOLT WASHERS FOR ALUMINUM HEADS

OUTSIDE SET (10) 17-4 PH WASHERS

6-9026	52.00
--------	-------

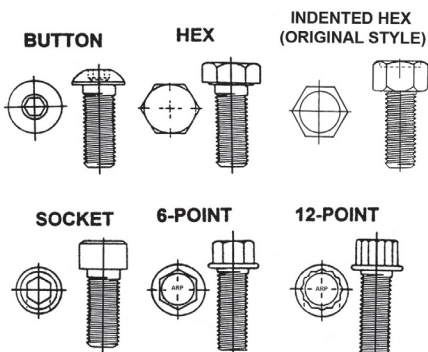

How about a 401 nailhead installed mid-ship in a 2 ton 1937 flatbed? It was 1973 - look how skinny we were!

KITS FOR CADILLAC ENGINES

331 - 365 - 390 - 425 - 429 - 472 - 500

ENGINE KITS- Every engine kit includes component kits for the Distributor, Fuel Pump, Intake, Oil Filter Housing, Oil Pan, Thermostat Housing, Timing Cover, Valve Covers, and Water Pump. The 331/365/390 kits also include component kits for the Coil Bracket, Valley Cover and Ground Straps.

331/365/EARLY 390 (UP THRU 1962)

HEX & INDENTED HEX -ORIGINAL STYLE - INCLUDES STUDS AND
SPECIAL 1 3/8 OD INTAKE WASHERS - 160 PC

** WE CAN MAKE KITS FOR THESE IN OTHER BOLT STYLES - JUST GIVE US A CALL **

Part #

Price

LATE 390 (1963 & UP) / 429

BUTTON & SOCKET HEAD
HEX & INDENTED HEX - ORIGINAL STYLE WITH INTAKE STUDS

425/472/500

BUTTON HEAD
HEX HEAD
INDENTED HEX -ORIGINAL STYLE
SOCKET HEAD
SIX POINT - POLISHED - HIGH STRENGTH
TWELVE POINT - POLISHED - HIGH STRENGTH

** NOTE INDENTED HEX, SIX POINT & TWELVE POINT BOLTS ARE MADE IN USA **

6-6700
6-6750
6-6751

145.75
105.00
139.00
62.00
67.00
79.00
71.00
321.00
344.25

ACCESSORY KITS (NOT INCLUDED IN THE ENGINE KIT)

BELLHOUSING KITS (1 1/2" LONG BOLTS)

SIX POINT - HIGH STRENGTH # 6-5180 \$ 42.00
TWELVE POINT - HIGH STRENGTH 6-5181 44.00

CARB MOUNT KITS - SEE PAGE 7

CRANK PULLEY KITS

- 331/365/EARLY 390:

SIX POINT - HIGH STRENGTH 6-6715 23.25

- 425/472/500 (STOCK 3/4" LONG BOLTS):

SIX POINT - HIGH STRENGTH 6-5750 15.75
TWELVE POINT - HIGH STRENGTH 6-5751 18.75

- 425/472/500 WITH BILLET PULLEY (1" LONG BOLTS):

SIX POINT - HIGH STRENGTH 6-5790 19.00

FAN PULLEY KITS -3/4" LONG BOLTS

-STEEL PULLEY WITHOUT A SPACER:

SIX POINT - HIGH STRENGTH 6-5609 17.50
TWELVE POINT - HIGH STRENGTH 6-5607 18.25

- ALUMINUM PULLEYS: WITH COUNTERSUNK

HOLES AND NO FAN BLADE
FLAT SOCKET 6-5608 5.25

HARMONIC BALANCER KIT

- 331/365/EARLY 390

SIX POINT # 6-6721 \$ 23.75

STARTER KITS

-331/365/EARLY 390:

HEX HEAD 6-6713 7.75

-425/472/500 - KNURLED

SIX POINT - HIGH STRENGTH 6-5718 30.50
TWELVE POINT - HIGH STRENGTH 6-5719 31.00

EXHAUST KITS

331/365:

HEX HEAD - STOCK 6-6719 31.50

390/429:

HEX HEAD - STOCK 6-6770 34.00
SIX POINT - FOR HEADERS 6-6769 62.75

425/472/500

HEX HEAD - STOCK 6-5117 24.75
SIX POINT - HIGH STRENGTH 6-5768 116.50
TWELVE POINT - HIGH STRENGTH 6-5597 121.75

- FOR 331-365, & 425-500 HEADERS SEE 16 COUNT KITS ON PAGES 6 & 7

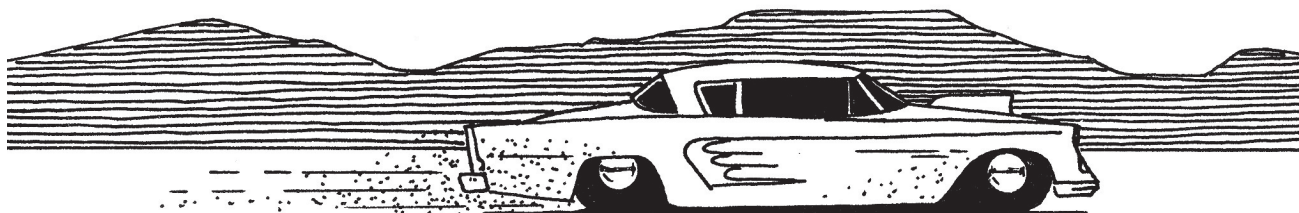

TOLL FREE ORDER LINE : 1-800-767-4781

KITS FOR CHEVY STRAIGHT SIX ENGINES

194 - 216 - 230 - 235 - 250 - 261 - 292

ENGINE KITS- Every engine kit includes component kits for the Distributor, Fuel Pump, Intake/Exhaust Manifold, Oil Pan, Side Cover (Push Rod CVR), Thermostat Housing, Timing Cover, Valve Cover, and Water Pump. Available in 6 different bolt styles!

FOR ENGINES WITH: Contains one of each component kit	CAST VALVE COVER	SHEET METAL VALVE COVER	PRICE:
216			
BUTTON/SOCKET HEAD		# 6-7610	\$ 57.00
HEX HEAD		6-7611	64.50
SLOTTED & HEX CAP - ORIGINAL STYLE		6-7612	67.00
SOCKET HEAD		6-7613	70.75
SIX POINT - POLISHED - HIGH STRENGTH		6-7652	265.75
TWELVE POINT - POLISHED - HIGH STRENGTH		6-7614	287.25
235 (1953-54)			
BUTTON/SOCKET HEAD	# 6-7653	6-7659	63.00
HEX HEAD	6-7654	6-7660	68.00
INDENTED HEX -ORIGINAL STYLE	6-7655	6-7661	74.50
SOCKET HEAD	6-7656	6-7662	76.00
SIX POINT - POLISHED - HIGH STRENGTH	6-7657	6-7663	295.25
TWELVE POINT - POLISHED - HIGH STRENGTH	6-7658	6-7664	306.25
235/261 (1955-62)			
BUTTON HEAD	6-7500	6-7594	63.00
HEX HEAD	6-7501	6-7595	68.00
HEX/INDENTED HEX -ORIGINAL STYLE	6-7503	6-7597	74.50
SOCKET HEAD	6-7502	6-7596	76.00
SIX POINT - POLISHED - HIGH STRENGTH	6-7504	6-7598	295.25
TWELVE POINT - POLISHED - HIGH STRENGTH	6-7505	6-7599	306.25
194/230/250/292			
BUTTON HEAD	6-7506	6-7600	67.00
HEX HEAD	6-7507	6-7601	70.50
HEX/INDENTED HEX -ORIGINAL STYLE	6-7509	6-7603	79.00
SOCKET HEAD	6-7508	6-7602	75.00
SIX POINT - POLISHED - HIGH STRENGTH	6-7510	6-7604	300.75
TWELVE POINT - POLISHED - HIGH STRENGTH	6-7511	6-7605	318.75

** NOTE INDENTED HEX, SIX POINT & TWELVE POINT BOLTS ARE MADE IN USA **

ACCESSORY KITS (NOT INCLUDED IN THE ENGINE KIT)

FRONT ENGINE MOUNT KITS

-194/230/250/292			
SIX POINT - HIGH STRENGTH	# 6-7586	\$ 26.25	
TWELVE POINT - HIGH STRENGTH	6-7587	28.25	
- 216/235 (1954 & EARLIER)			
CARRIAGE HEAD	6-7672	74.00	
- 235/261 (1955-62)			
SIX POINT - HIGH STRENGTH	6-7584	20.50	
TWELVE POINT - HIGH STRENGTH	6-7585	23.00	

GENERATOR MOUNT KITS - 235 & 261 ONLY

BUTTON HEAD	6-7681	5.25	
HEX HEAD	6-7590	5.50	
SOCKET HEAD	6-7591	5.50	
SIX POINT - HIGH STRENGTH	6-7592	12.25	
TWELVE POINT - HIGH STRENGTH	6-7593	13.75	

HEAD BOLT KIT - OUTSIDE BOLTS ONLY

235-261 (1955-62) - HIGH STRENGTH BOLTS & WASHERS:		
SIX POINT - POLISHED	# 6-7609	\$ 146.00

INTAKE/EXHAUST FOR HEADERS

-194/230/250/292		
SIX POINT - HIGH STRENGTH	6-7670	40.25
TWELVE POINT - HIGH STRENGTH	6-7671	43.75

STARTER KITS - 216/235/261 ONLY

HEX HEAD	6-7588	5.75
SOCKET HEAD	6-7589	6.00
SIX POINT - HIGH STRENGTH	6-7682	13.25
TWELVE POINT - HIGH STRENGTH	6-7683	14.50

KITS FOR CHEVY 2.8 / 3.4 LITER V6 ENGINES

ENGINE KITS- Every engine kit includes component kits for the Distributor, Fuel Pump, Intake, Oil Pan, Thermostat, Timing Cover, Valve Covers, and Water Pump.

Contains one of each component kit		
BUTTON HEAD	# 5-1300	\$ 54.75
HEX HEAD	5-1301	50.50
SOCKET HEAD	5-1302	55.75
SIX POINT - POLISHED - HIGH STRENGTH - MADE IN USA	5-1322	353.00
TWELVE POINT - POLISHED - HIGH STRENGTH - MADE IN USA	5-1323	390.00

KITS FOR 4.3 LITER V6 CHEVY ENGINES

ENGINE KITS- Every engine kit includes component kits for the Distributor, Fuel Pump, Intake Manifold, Oil Pan, Thermostat Housing, Timing Cover, Valve Covers, and Water Pump. Available in 5 different bolt styles and includes 125 pieces!

ENGINE KITS WITH:	CENTER BOLT VALVE COVERS	CAST VALVE COVERS	SHEET METAL VALVE COVERS	Price
BUTTON HEAD		# 6-5422	#6-5400	\$ 55.00
BUTTON HEAD	# 6-5466			57.00
HEX HEAD		6-5423	6-5401	57.00
HEX HEAD	6-5415			59.75
SOCKET HEAD		6-5424	6-5402	64.75
SOCKET HEAD	6-5416			67.00
SIX POINT - POLISHED - HIGH STRENGTH		6-5425	6-5403	250.75
SIX POINT - POLISHED	6-5440			268.75
TWELVE POINT - POLISHED - HIGH STRENGTH		6-5426	6-5404	277.50
TWELVE POINT - POLISHED	6-5441			295.00

** NOTE SIX POINT & TWELVE POINT BOLTS ARE MADE IN USA **

ACCESSORY KITS (NOT INCLUDED IN THE ENGINE KIT)

BELLHOUSING KITS - SEE PAGE 29

ENGINE MOUNT KIT - MOUNTS TO BLOCK

SIX POINT - HIGH STRENGTH	# 6-5113	\$ 29.75
TWELVE POINT - HIGH STRENGTH	6-5114	31.75

7/16-14 PIVOT BOLTS NOT INCLUDED - MEASURE THE LENGTH AND ORDER (2) 6 OR 12 POINT BOLTS & NUTS

EXHAUST BOLT KITS

-HEADERS: SEE 12 COUNT KITS- PAGES 6 & 7

-STOCK EXHAUST:

SIX POINT - HIGH STRENGTH	6-5420	91.75
TWELVE POINT - HIGH STRENGTH	6-5421	95.75

CARB MOUNT KITS - SEE PAGE 7

STARTER KITS-WITH KNURLED BOLTS 3 3/4" LONG

BOLTS: ALSO AVAILABLE IN 4", 4-1/4", & 4-1/2" SEE PG 22.

SIX POINT - HIGH STRENGTH	# 6-5456	\$ 31.00
TWELVE POINT - HIGH STRENGTH	6-5454	33.25

FAN PULLEY KITS - 3/4" LONG BOLTS

- STEEL PULLEYS WITHOUT A SPACER:

SIX POINT - HIGH STRENGTH	6-5609	17.50
TWELVE POINT - HIGH STRENGTH	6-5607	18.25

- ALUMINUM PULLEYS: WITH COUNTERSUNK HOLES AND NO FAN BLADE

FLAT SOCKET	6-5608	5.25
-------------	--------	------

KITS FOR CHEVY LS ENGINES

ENGINE KITS- Every engine kit includes component kits for the Coil & Harness, Intake Manifold, Oil Pan, Sensor, Thermostat, Timing Cover, Valley Cover, Valve Cover, & Water Crossover.

NOTE: On the Valve Covers, tap the stock bolts out of the original tubes & REUSE the tubes.

Contains one of each component kit	1997 & 1998	Price	1999 & UP	Price
BUTTON/SOCKET HEAD	# 5-1500	\$ 107.00	# 5-1520	\$ 106.00
SOCKET HEAD	5-1501	105.50	5-1521	103.75
SIX POINT - POLISHED - HIGH STRENGTH	5-1550	667.50	5-1552	588.75
TWELVE POINT - POLISHED - HIGH STRENGTH	5-1551	724.25	5-1553	657.75

** NOTE SIX POINT & TWELVE POINT BOLTS ARE MADE IN USA **

ACCESSORY KITS (NOT INCLUDED IN THE ENGINE KIT)

BELLHOUSING KITS

- 5 BOLT TYPE:

HEX HEAD - MEDIUM STRENGTH	# 5-1532	\$ 21.00
SOCKET HEAD - MEDIUM STRENGTH	5-1530	23.75
SIX POINT - HIGH STRENGTH	5-1574	46.00
TWELVE POINT - HIGH STRENGTH	5-1575	47.00

- 7 BOLT TYPE:

HEX HEAD - MEDIUM STRENGTH	5-1533	26.75
SOCKET HEAD - MEDIUM STRENGTH	5-1531	32.00
SIX POINT - HIGH STRENGTH	5-1582	63.50
TWELVE POINT - HIGH STRENGTH	5-1583	66.25

EXHAUST KITS

- SEE 12 & 16 COUNT 8MM KITS ON PAGES 6 & 7

ENGINE MOUNT KITS

3 BOLT TYPE MOUNTS (35MM LONG BOLTS):

SIX POINT - HIGH STRENGTH	# 5-1576	\$ 53.50
TWELVE POINT - HIGH STRENGTH	5-1577	56.00

4 BOLT TYPE MOUNTS (25MM LONG BOLTS):

SIX POINT - HIGH STRENGTH	5-1586	47.25
TWELVE POINT - HIGH STRENGTH	5-1587	52.00

STARTER KITS-WITH KNURLED BOLTS

(1) SHORT (45 MM) & (1) 114 MM LONG BOLT

SIX POINT - HIGH STRENGTH	# 5-1594	\$ 29.25
---------------------------	----------	----------

(2) 114MM LONG BOLTS

SIX POINT - HIGH STRENGTH	5-1588	30.25
---------------------------	--------	-------

OIL PAN PLUGS-WITH QUAD-SEAL O-RINGS

BUTTON HEAD (LOW PROFILE)	1-6004	12.00
---------------------------	--------	-------

SIX POINT - HIGH STRENGTH	1-6006	19.50
---------------------------	--------	-------

TWELVE POINT - HIGH STRENGTH	1-6007	20.00
------------------------------	--------	-------

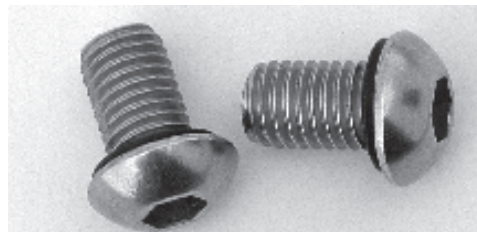

**ENGINE KITS
FOR CHEVY SMALL
BLOCK ENGINES**
265-283-305-307-327-350-400

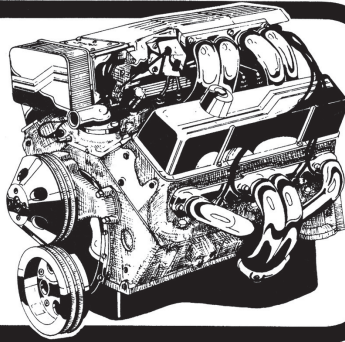

ENGINE KITS- Each engine kit includes component kits for the Distributor, Fuel Pump (except TPI engines), Intake, Sheet Metal Oil Pan, Thermostat, Sheet Metal Timing Cover, Valve Covers, and Water Pump.

PLEASE STATE IF YOU HAVE A CAST OIL PAN (OR ONE WITH REINFORCED SIDE RAILS) OR A CAST TIMING COVER

* NOTE INDENTED HEX, SIX POINT & 12 POINT BOLTS ARE MADE IN USA * FOR ENGINES WITH LONG WATER PUMPS FOR ENGINES WITH SHORT WATER PUMPS PRICE:

KITS WITH CAST ALUMINUM VALVE COVERS

BUTTON HEAD	# 6-5643	# 6-5652	\$ 51.00
HEX HEAD	6-5644	6-5653	57.00
HEX/INDENTED HEX HEAD - ORIGINAL STYLE FOR ENGINES 55-62 WITH INDENTED HEX BOLTS USED WHERE APPROPRIATE			
		6-5657	68.75
HEX/INDENTED HEX - ORIGINAL STYLE: 63 & UP	6-5696	6-5697	69.00
SOCKET HEAD	6-5645	6-5654	65.50
SIX POINT - POLISHED - HIGH STRENGTH	6-5646	6-5655	269.75
TWELVE POINT - POLISHED - HIGH STRENGTH	6-5647	6-5656	291.00

KITS WITH SHEET METAL, STOCK, CHROME VALVE COVERS

BUTTON HEAD	6-5002	6-5660	51.00
HEX HEAD	6-5000	6-5661	57.00
HEX/INDENTED HEX - ORIGINAL STYLE: 55-62			
	6-5698	6-5005	66.75
HEX/INDENTED HEX - ORIGINAL STYLE: 63 & UP			
	6-5699	6-5662	69.00
SOCKET HEAD	6-5001	6-5663	67.00
SIX POINT - POLISHED - HIGH STRENGTH	6-5071	6-5664	267.25
TWELVE POINT - POLISHED - HIGH STRENGTH	6-5072		287.00

KITS WITH CENTER BOLT VALVE COVERS

BUTTON HEAD	6-5498	6-5499	61.00
HEX HEAD	6-5097	6-5667	67.00
SOCKET HEAD	6-5642	6-5668	71.00
SIX POINT - POLISHED - HIGH STRENGTH	6-5444	6-5446	291.00
TWELVE POINT - POLISHED - HIGH STRENGTH	6-5445	6-5447	312.75

KITS FOR TPI ENGINES WITH CAST ALUMINUM VALVE COVERS

BUTTON HEAD	6-5648	6-5658	87.00
SOCKET HEAD	6-5649	6-5659	95.00
SIX POINT - POLISHED - HIGH STRENGTH	6-5459	6-7895	478.50
TWELVE POINT - POLISHED - HIGH STRENGTH	6-5460	6-7896	515.00

KITS FOR TPI ENGINES WITH SHEET METAL VALVE COVERS

BUTTON HEAD	6-5080	6-5665	87.00
SOCKET HEAD	6-5129	6-5666	95.00
SIX POINT - POLISHED - HIGH STRENGTH	6-5461	6-7897	478.50
TWELVE POINT - POLISHED - HIGH STRENGTH	6-7966	6-7967	515.00

KITS FOR TPI ENGINES WITH CENTER BOLT VALVE COVERS

BUTTON HEAD	6-5650	6-5669	91.00
SOCKET HEAD	6-5651	6-5670	98.50
SIX POINT - POLISHED - HIGH STRENGTH	6-7898	6-7968	502.25
TWELVE POINT - POLISHED - HIGH STRENGTH	6-5464	6-7894	535.75

KITS FOR LT-1/LT-4 TPI ENGINES WITH CENTER BOLT VALVE COVERS

BUTTON HEAD		6-5437	91.00
SOCKET HEAD		6-5438	96.50
SIX POINT - POLISHED - HIGH STRENGTH		6-5473	405.00
TWELVE POINT - POLISHED - HIGH STRENGTH		6-5474	441.00

KITS FOR "VORTEC" ENGINES

BUTTON HEAD	6-5475		52.00
HEX HEAD	6-5476		58.00
INDENTED HEX HEAD - ORIGINAL STYLE			
	6-8299		63.75
SOCKET HEAD	6-5477		61.00
SIX POINT - POLISHED - HIGH STRENGTH	6-5478		275.75
TWELVE POINT - POLISHED - HIGH STRENGTH	6-5479		297.75

TOLL FREE ORDER LINE : 1-800-767-4781

22 ACCESSORY KITS FOR SMALL BLOCK CHEVY ENGINES

(NOT INCLUDED IN ENGINE KITS - EXCEPT L89 TPI INTAKE KITS)

BELLHOUSING KITS - SEE PAGE 29

CARB MOUNT KITS - SEE PAGE 7

CRANK PULLEY KITS - 3/4" LONG BOLTS

SIX POINT - HIGH STRENGTH	# 6-5620	\$ 15.00
TWELVE POINT - HIGH STRENGTH	6-5160	16.00

ENGINE MOUNT KITS - MOUNTS TO BLOCK -

* 7/16-14 PIVOT BOLTS NOT INCLUDED - MEASURE THE LENGTH AND ORDER (2) 6 OR 12 POINT BOLTS & NUTS *

SIX POINT - HIGH STRENGTH	6-5113	29.75
TWELVE POINT - HIGH STRENGTH	6-5114	31.75

EXHAUST BOLT KITS

- 2 1/4" LONG BOLTS - (FOR STOCK SBC, EXCEPT RAMS HORN) STUDS NOT INCLUDED

HEX HEAD - HAS STOCK APPEARANCE, BUT NOT AS STRONG AS STOCK	6-5051	23.25
SIX POINT - HIGH STRENGTH	6-5052	93.75
TWELVE POINT - HIGH STRENGTH	6-5056	96.75

- MANIFOLD KITS FOR CHEVY V8 RAMS HORN

-INCLUDES BOLTS FOR COLLECTOR FLANGES:		
HEX HEAD-HAS STOCK APPEARANCE, BUT NOT AS STRONG AS STOCK	6-5006	33.00
SIX POINT - HIGH STRENGTH	6-5007	138.50
TWELVE POINT - HIGH STRENGTH	6-5008	145.00
-INCLUDES STUDS FOR COLLECTOR FLANGES:		
HEX HEAD	6-5594	72.25
SIX POINT/HEX NUTS - HIGH STRENGTH	6-5595	156.50
12 POINT/12 PT NUTS - HIGH STRENGTH	6-5596	161.75

- 12 COUNT HEADER KITS SEE PAGES 6 & 7

STUD BOLT FOR EXHAUST 3/8-16 X 2-1/4

HIGH STRENGTH 17-4 PH STAINLESS WITH A 3/8-16 X 1" STUD ON TOP	2-7108	18.00
--	--------	-------

HEAD BOLT KITS

-COMPLETE(INSIDE & OUTSIDE) SET		
SIX POINT - HIGH STRENGTH	6-5677	318.75
TWELVE POINT - HIGH STRENGTH	6-5678	357.50
-OUTSIDE BOLTS ONLY		
SIX POINT - HIGH STRENGTH	6-5066	128.50
TWELVE POINT - HIGH STRENGTH	6-5169	135.50

HEAD BOLT WASHERS FOR ALUMINUM HEADS

(SPECIAL GROUND AND BEVELED WASHERS BY ARP)		
OUTSIDE SET	6-5621	37.00
COMPLETE SET	6-5622	76.75

HARMONIC BALANCER BOLT KITS

-HEAVY DUTY WASHER WITH 2" LONG BOLT

SIX POINT - HIGH STRENGTH	6-5482	23.50
TWELVE POINT - HIGH STRENGTH	6-5483	24.75

-HEAVY DUTY WASHER WITH 2 1/4" LONG BOLT

SIX POINT - HIGH STRENGTH	6-5480	24.00
TWELVE POINT - HIGH STRENGTH	6-5481	25.00

-HEAVY DUTY WASHER WITH 2 1/2" LONG BOLT

SIX POINT - HIGH STRENGTH	6-5484	24.25
TWELVE POINT - HIGH STRENGTH	6-5485	25.50

-UNIVERSAL KIT WITH HEAVY DUTY WASHER & (1) EACH 2", 2 1/4", & 2 1/2" LONG BOLTS

SIX POINT - HIGH STRENGTH	6-5487	42.00
TWELVE POINT - HIGH STRENGTH	6-5488	43.00

FAN PULLEY KIT- SEE PAGE 23 (Same as BBC)

BASIC L89 TPI KITS - INCLUDED IN TPI ENGINE KITS:

INCLUDES ALL BOLTS FROM MANIFOLD UP (ALL METRIC)		
DOES NOT INCLUDE MANIFOLD TO HEAD BOLTS		
BUTTON HEAD	# 6-5010	\$ 39.50
SOCKET HEAD	6-5081	41.25
SIX POINT - HIGH STRENGTH	6-5457	224.25
TWELVE POINT - HIGH STRENGTH	6-5458	242.75

KITS FOR RAM JET TPI INTAKE

BUTTON HEAD	6-5580	15.50
HEX HEAD	6-5462	16.75
SIX POINT - HIGH STRENGTH	6-5463	57.75
TWELVE POINT - HIGH STRENGTH	6-7899	66.25

OIL PAN PLUG

TRUSS SOCKET HEAD	7-0402	20.00
-------------------	--------	-------



STARTER KITS - WITH KNURLED BOLTS

- LOW TORQUE: 1 LONG & 1 SHORT BOLT

HEX HEAD	6-5068	18.00
SIX POINT - HIGH STRENGTH	6-5152	30.50
TWELVE POINT - HIGH STRENGTH	6-5671	31.00

- HIGH TORQUE STARTERS: WITH 3 3/4" LONG BOLTS:

SIX POINT - HIGH STRENGTH	6-5456	31.00
TWELVE POINT - HIGH STRENGTH	6-5454	33.25

WITH 4" LONG BOLTS:

SIX POINT - HIGH STRENGTH	6-5450	33.25
TWELVE POINT - HIGH STRENGTH	6-5451	34.25

WITH 4 1/4" LONG BOLTS:

SIX POINT - HIGH STRENGTH	6-7983	32.00
TWELVE POINT - HIGH STRENGTH	6-7984	33.50

WITH 4.5" LONG BOLTS

HEX HEAD	6-5048	19.00
SIX POINT - HIGH STRENGTH	6-5171	38.75
TWELVE POINT - HIGH STRENGTH	6-5232	40.25

SERPENTINE BELT DRIVE KITS FOR CHEVY/GMC TRUCKS & SUV'S WITH 350 V8 ENGINES -1990-95:

BUTTON & SOCKET HEAD	6-1565	70.75
HEX & INDENTED HEX HEAD	6-1566	60.25
SOCKET HEAD	6-1567	78.25
SIX POINT - HIGH STRENGTH	6-1568	162.00
TWELVE POINT - HIGH STRENGTH	6-1569	172.50

-1996-98 C/K TRUCKS & 1996-2000 FULL SIZE SUV'S

HEX HEAD	6-1571	36.25
SOCKET HEAD	6-1572	42.75
SIX POINT - HIGH STRENGTH	6-1579	83.75
TWELVE POINT - HIGH STRENGTH	6-1570	94.50

STUD BOLT FOR INTAKE 3/8-16 X 1-1/4" HIGH

STRENGTH 17-4 PH STAINLESS WITH A 3/8-16 x 3/4" STUD ON TOP		
	2-7106	16.50

STUD BOLTS FOR WATER PUMP

3/8-16 X 1-3/4" HIGH STRENGTH 17-4 PH STAINLESS WITH A 3/8-16 x 7/8" STUD ON TOP		
	2-7110	17.00
3/8-16 X 2" HIGH STRENGTH 17-4 PH STAINLESS WITH A 3/8-16 x 1" STUD ON TOP		
	2-6994	17.50

BUTTON

HEX

INDENTED HEX (ORIGINAL STYLE)

SOCKET

6-POINT

12-POINT

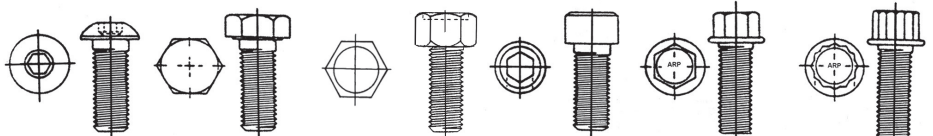

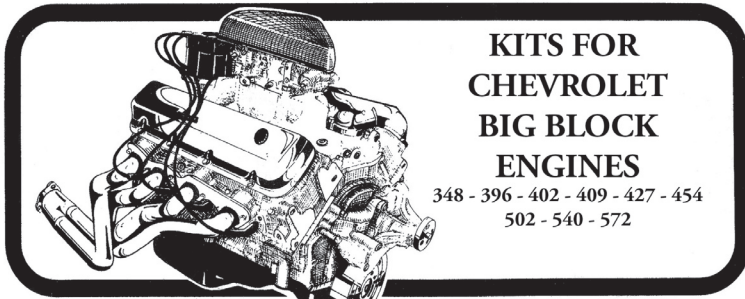

KITS FOR CHEVROLET BIG BLOCK ENGINES

348 - 396 - 402 - 409 - 427 - 454
502 - 540 - 572

KITS FOR BIG BLOCK CHEVY ENGINES

Each engine kit includes component kits for the Distributor, Fuel Pump, Intake, Oil Pan, Thermostat, Timing Cover, Valve Covers, and Water Pump.

* NOTE INDENTED HEX, SIX POINT & 12 POINT BOLTS ARE MADE IN USA *

FOR ENGINES WITH CAST VALVE COVERS

FOR ENGINES WITH SHEET METAL VALVE COVERS

PRICE:

348 - 409

BUTTON HEAD	# 6-5672	# 6-5600	\$ 51.00
HEX INDENTED HEX - ORIGINAL STYLE	6-5605	6-5606	79.00
SOCKET HEAD	6-5674	6-5602	63.50
SIX POINT - POLISHED - HIGH STRENGTH	6-5675	6-5603	304.00
TWELVE POINT - POLISHED - HIGH STRENGTH	6-5676	6-5604	328.25

396 - 402 - 427 - 454 KITS WITH LONG WATER PUMP

BUTTON HEAD	6-5680	6-5102	52.50
HEX/INDENTED HEX - ORIGINAL STYLE	6-5115	6-5116	69.00
SOCKET HEAD	6-5682	6-5101	65.75
SIX POINT - POLISHED - HIGH STRENGTH	6-5683	6-5162	317.50
TWELVE POINT - POLISHED - HIGH STRENGTH	6-5684	6-5163	339.75

396 - 402 - 427 - 454 KITS WITH SHORT WATER PUMP

BUTTON HEAD	6-5685	6-5690	54.50
HEX/INDENTED HEX - ORIGINAL STYLE	6-5132	6-5133	79.00
SOCKET HEAD	6-5687	6-5692	65.75
SIX POINT - POLISHED - HIGH STRENGTH	6-5688	6-5693	311.75
TWELVE POINT - POLISHED - HIGH STRENGTH	6-5689	6-5694	344.00

502 (GEN 5) WITH STANDARD LONG PUMP

BUTTON HEAD	6-7987		59.00
HEX/INDENTED HEX HEAD - ORIGINAL STYLE	6-7989		79.00
SOCKET HEAD	6-7990		72.75
SIX POINT - POLISHED - HIGH STRENGTH	6-7991		295.75
TWELVE POINT - POLISHED - HIGH STRENGTH	6-7992		304.00

502 - 540 - 572 (GEN 6)- WITH STANDARD LONG PUMP

BUTTON HEAD	6-7960		61.00
HEX/INDENTED HEX HEAD - ORIGINAL STYLE	6-7962		79.00
SOCKET HEAD	6-7963		73.50
SIX POINT - POLISHED - HIGH STRENGTH	6-7964		324.00
TWELVE POINT - POLISHED - HIGH STRENGTH	6-7965		346.50

ACCESSORY KITS (NOT INCLUDED IN THE ENGINE KIT)

CRANK PULLEY KITS - 3/4" LONG BOLTS

SIX POINT - HIGH STRENGTH	# 6-7976	\$ 14.25
TWELVE POINT - HIGH STRENGTH	6-7975	15.25

EXHAUST BOLT KITS

- 348-409 SEE 14 COUNT BOLT KITS ON PAGES 6 & 7
- 396-572 SEE 16 COUNT BOLT KITS ON PAGES 6 & 7

OUTSIDE HEAD BOLT KITS

-348/409

SIX POINT - HIGH STRENGTH	6-5635	146.75
TWELVE POINT - HIGH STRENGTH	6-7973	157.75

-396-402-427-454 ONLY

SIX POINT - HIGH STRENGTH	6-5112	181.00
TWELVE POINT - HIGH STRENGTH	6-5452	210.00

-502-540-572 (WITH SPECIAL HEADBOLT WASHERS)

SIX POINT - HIGH STRENGTH	6-7985	260.25
TWELVE POINT - HIGH STRENGTH	6-7986	265.50

HARMONIC BALANCER KIT

-FOR ENGINES WITH A 2 1/2" LONG BOLT

SIX POINT - HIGH STRENGTH	6-5491	29.00
TWELVE POINT - HIGH STRENGTH	6-7972	30.50

BELLHOUSING KITS - SEE PAGE 29

CARB MOUNT KITS - SEE PAGE 7

ENGINE MOUNT KITS - MOUNTS TO BLOCK -

7/16-14 PIVOT BOLTS NOT INCLUDED - MEASURE THE LENGTH AND ORDER (2) 6 OR 12 POINT BOLTS & NUTS
SIX POINT - HIGH STRENGTH # 6-5113 \$ 29.75
TWELVE POINT - HIGH STRENGTH 6-5114 31.75

FAN PULLEY KITS - 3/4" LONG BOLTS

-STEEL PULLEYS WITHOUT A SPACER:

SIX POINT - HIGH STRENGTH	6-5609	17.50
TWELVE POINT - HIGH STRENGTH	6-5607	18.25

-ALUMINUM PULLEYS: WITH COUNTERSUNK HOLES AND NO FAN BLADE:

FLAT SOCKET	6-5608	5.25
-------------	--------	------

STARTER BOLTS - KNURLED BOLTS

-HIGH TORQUE AFTERMARKET STARTERS: 4" LONG BOLTS

SIX POINT - HIGH STRENGTH	6-5450	33.25
TWELVE POINT - HIGH STRENGTH	6-5451	34.25

-STOCK 502 STARTERS: 4 1/4" BOLTS

SIX POINT - HIGH STRENGTH	6-7983	32.00
TWELVE POINT - HIGH STRENGTH	6-7984	33.50

-HIGH TORQUE STOCK STARTER: 4 1/2" LONG BOLTS

HEX HEAD	6-5048	19.00
SIX POINT - HIGH STRENGTH	6-5171	38.75
TWELVE POINT - HIGH STRENGTH	6-5232	40.25

TOLL FREE ORDER LINE : 1-800-767-4781

KITS FOR OLDSMOBILE ENGINES: 260 thru 455

Each engine kit includes component kits for the Distributor, Fuel Pump, Intake, Oil Filter, Oil Pan, Thermostat, Timing Cover, Valve Covers, and Water Pump.

** NOTE INDENTED HEX, SIX POINT & 12 POINT BOLTS ARE MADE IN USA **	FOR ENGINE WITH CAST VALVE COVERS	FOR ENGINES WITH SHEET METAL VALVE COVERS	PRICE:
BUTTON HEAD	# 6-5390	# 6-5300	\$ 60.50
INDENTED/HEX HEAD - ORIGINAL STYLE	6-5398	6-5399	77.25
SOCKET HEAD	6-5392	6-5302	68.75
SIX POINT - POLISHED - HIGH STRENGTH	6-5393	6-5384	306.50
TWELVE POINT - POLISHED - HIGH STRENGTH	6-5394	6-5385	333.50

ACCESSORY KITS (NOT INCLUDED IN THE ENGINE KIT)

BELLHOUSING KITS -SEE PAGE 29

CRANK PULLEY KITS

SIX POINT - HIGH STRENGTH	# 6-5334	\$17.50
TWELVE POINT - HIGH STRENGTH	6-5335	18.25

EXHAUST BOLT KITS

- SEE 10 COUNT BOLT KITS ON PAGES 6 & 7

STARTER KITS - WITH KNURLED BOLTS: HIGH TORQUE - 4-1/2" LONG BOLTS

HEX HEAD	6-5048	19.00
SIX POINT - HIGH STRENGTH	6-5171	38.75
TWELVE POINT - HIGH STRENGTH	6-5232	40.25

LOW TORQUE STARTER - 2" & 4" LONG BOLTS

HEX HEAD	6-5332	17.00
SIX POINT - HIGH STRENGTH	6-5396	39.75
TWELVE POINT - HIGH STRENGTH	6-5397	40.50

STUD BOLT KIT FOR WATER PUMP

(2) 5/16 X 1 1/2" & (1) 2 1/2" stud bolts	6-3896	41.25
---	--------	-------

CARB MOUNT KITS - SEE PAGE 7

ENGINE MOUNT KITS

SIX POINT - HIGH STRENGTH	# 6-5350	\$ 24.50
TWELVE POINT - HIGH STRENGTH	6-5351	25.75

HARMONIC BALANCER KIT - WITH BILLET WASHER

SIX POINT - HIGH STRENGTH	6-3895	58.25
---------------------------	--------	-------

HEAT RISER & EGR VALVE KITS

BUTTON HEAD	6-5336	7.00
INDENTED HEX	6-5379	9.75
SOCKET HEAD	6-5338	7.75
SIX POINT - HIGH STRENGTH	6-5343	19.75
TWELVE POINT - HIGH STRENGTH	6-5344	20.75

OUTSIDE HEAD BOLT KITS -1976 AND EARLIER

SIX POINT - HIGH STRENGTH	6-5395	110.00
TWELVE POINT - HIGH STRENGTH	6-5352	125.50

STUD BOLT & BUSHING FOR TIMING COVER

6-3897	19.00
--------	-------

KITS FOR OLDS ROCKET ENGINES

Each engine kit includes component kits for the Crankcase Breather, Distributor, Fuel Pump, Intake, Oil Filter Housing, Oil Pan, Temperature Sensor, Thermostat, Timing Cover, Valley Cover, Valve Covers, and Water Pump.

** NOTE INDENTED HEX, SIX POINT & 12 POINT BOLTS ARE MADE IN USA **

303/324/371 (THRU 1958)

BUTTON HEAD	# 6-4300	87.00
HEX HEAD	6-4301	87.00
SOCKET HEAD	6-4302	95.75
SIX POINT - POLISHED - HIGH STRENGTH	6-4303	381.75
TWELVE POINT - POLISHED - HIGH STRENGTH	6-4304	402.00

FOR ENGINES WITH WITH STOCK INTAKE:

Price:	\$ 87.00
	87.00
	95.75
	381.75
	402.00

WITH AN EDELBROCK 3-2'S INTAKE:

# 6-4425	\$ 81.00
6-4426	82.00
6-4427	89.00
6-4428	344.00
6-4429	334.75

371 & 394 (1959-60)

BUTTON HEAD	# 6-4450	
HEX HEAD	6-4451	
SOCKET HEAD	6-4452	
SIX POINT - POLISHED - HIGH STRENGTH	6-4453	
TWELVE POINT - POLISHED - HIGH STRENGTH	6-4454	

FOR ENGINES WITH CAST VALVE COVERS

FOR ENGINES WITH SHEET METAL VALVE COVERS

# 6-4305	\$ 86.00
6-4306	85.00
6-4307	90.00
6-4308	384.75
6-4309	404.00

394 (1961-64)

BUTTON HEAD	6-4430	
HEX HEAD	6-4431	
SOCKET HEAD	6-4432	
SIX POINT - POLISHED - HIGH STRENGTH	6-4433	
TWELVE POINT - POLISHED - HIGH STRENGTH	6-4434	



ROCKET 394 IN A HENRY J

6-4400	73.00
6-4401	77.00
6-4402	80.00
6-4403	359.25
6-4404	379.25

ACCESSORY KITS (NOT INCLUDED IN THE ENGINE KIT)

BELLHOUSING KITS

SIX POINT - HIGH STRENGTH	# 6-4410	\$ 63.00
TWELVE POINT - HIGH STRENGTH	6-4411	64.25

HARMONIC BALANCER KITS

SIX POINT - HIGH STRENGTH	6-4424	24.00
---------------------------	--------	-------

OUTSIDE HEADBOLT KITS

SIX POINT - HIGH STRENGTH	6-4423	213.25
---------------------------	--------	--------

STARTER KITS

HEX HEAD	6-4416	6.00
SOCKET HEAD	6-4417	8.00
SIX POINT - HIGH STRENGTH	6-4456	18.25
TWELVE POINT - HIGH STRENGTH	6-4457	19.75

EXHAUST BOLT KITS - SEE 12 COUNT BOLT KITS ON PAGES 6 & 7 STOCK EXHAUST KIT:

HEX HEAD WITH STUDS & WEDGE LOCKS	# 6-4458	\$ 89.00
-----------------------------------	----------	----------

INTAKE WASHERS - 1.35" OD

SET OF (4) 1/4" THICK - MADE IN USA	6-4459	43.50
-------------------------------------	--------	-------

FRONT ENGINE MOUNT KITS

SIX POINT - HIGH STRENGTH	6-4408	20.50
TWELVE POINT - HIGH STRENGTH	6-4409	22.25

STARTER/FLYWHEEL HOUSING KITS

HEX HEAD	6-4414	14.25
----------	--------	-------

CARB MOUNT KITS - SEE PAGE 7

KITS FOR PONTIAC V8 ENGINES

Each engine kit includes component kits for the Distributor, Fuel Pump, Intake, Oil Filter, Oil Pan, Thermostat, Timing Cover, Valve Covers, and Water Pump.

** NOTE INDENTED HEX, SIX POINT & 12 POINT BOLTS ARE MADE IN USA **	FOR ENGINE WITH CAST VALVE COVERS	FOR ENGINES WITH SHEET METAL VALVE COVERS	PRICE:
ENGINE KITS FOR 287 - 317 - 347 - 370 - 389 (1960 & EARLIER)			
BUTTON AND SOCKET HEAD	# 6-2850	# 6-2885	\$ 61.75
HEX HEAD	6-2851	6-2886	67.00
SOCKET HEAD	6-2852	6-2887	68.00
SIX POINT - POLISHED - HIGH STRENGTH	6-2853	6-2888	279.75
TWELVE POINT - POLISHED - HIGH STRENGTH	6-2854	6-2889	311.50

ENGINE KITS FOR 326 - 350 - 389 (1961 & UP) - 400 - 421 - 428 - 455			
BUTTON AND SOCKET HEAD	# 6-5260	# 6-5200	\$ 59.50
HEX HEAD	6-5261	6-5201	67.00
HEX/INDENTED HEX - ORIGINAL STYLE	6-5280	6-5281	76.50
SOCKET HEAD	6-5262	6-5202	68.00
SIX POINT - POLISHED - HIGH STRENGTH	6-5265	6-5267	280.50
TWELVE POINT - POLISHED - HIGH STRENGTH	6-5266	6-5268	312.00

ACCESSORY KITS (NOT INCLUDED IN THE ENGINE KIT)

BELLHOUSING KITS - SEE PAGE 29

CARB MOUNT KITS - SEE PAGE 7

CRANK PULLEY KITS - 1967 & UP

SIX POINT - HIGH STRENGTH	# 6-5291	\$16.50
TWELVE POINT - HIGH STRENGTH	6-5273	17.50

ENGINE MOUNT KITS

SIX POINT - HIGH STRENGTH	6-5276	25.75
TWELVE POINT - HIGH STRENGTH	6-5277	27.00

FAN PULLEY KITS - 3/4" LONG BOLTS

-STEEL PULLEYS WITHOUT A SPACER:		
SIX POINT - HIGH STRENGTH	6-5609	17.50
TWELVE POINT - HIGH STRENGTH	6-5607	18.25

-ALUMINUM PULLEYS: WITH NO FAN BLADE:		
FLAT SOCKET	6-5608	5.25

EXHAUST BOLT KITS - SEE 12 COUNT BOLT KITS ON PAGES 6 & 7

HARMONIC BALANCER KIT - WITH BILLET WASHER
SIX POINT - HIGH STRENGTH # 6-5235 \$ 48.75

OUTSIDE HEAD BOLT KITS

SIX POINT - HIGH STRENGTH	6-5253	132.50
TWELVE POINT - HIGH STRENGTH	6-5274	133.25

HEAD BOLT WASHERS FOR ALUMINUM HEADS

OUTSIDE SET (10) 17-4 PH WASHERS	6-9026	52.00
STUD BOLT FOR INTAKE 3/8-16 WITH 5/16-18 X 5/8" STUD ON TOP	2-7020	20.00

STARTER KITS - WITH KNURLED 4" BOLTS

SIX POINT - HIGH STRENGTH	6-5450	33.25
TWELVE POINT - HIGH STRENGTH	6-5451	34.25

KITS FOR OVERHEAD CAM SIX CYLINDER - SEE PAGE 28!

KITS FOR 304-345-392 INTERNATIONAL ENGINES

ENGINE KITS- Every engine kit includes component kits for the Distributor, Fuel Pump, Intake, Oil Filter, Oil Pan, Thermostat, Timing Cover, Valley Cover, Valve Covers, and Water Pump.

BUTTON & SOCKET HEAD	# 6-3900	\$ 70.00
HEX HEAD	6-3901	71.00
HEX & INDENTED HEX HEAD - ORIGINAL STYLE	6-3902	75.50
SOCKET HEAD	6-3903	83.50
SIX POINT - POLISHED - HIGH STRENGTH	6-3904	346.25
TWELVE POINT - POLISHED - HIGH STRENGTH	6-3905	374.75

** NOTE INDENTED HEX, SIX POINT & TWELVE POINT BOLTS ARE MADE IN USA **

ACCESSORY KITS: (NOT INCLUDED IN THE ENGINE KIT)

BELLHOUSING KITS - FOR 727 TORQUEFLITE

HEX HEAD	# 6-3977	\$ 21.00
SOCKET HEAD	6-3973	21.75
SIX POINT - HIGH STRENGTH	6-3974	79.25

EXHAUST BOLT KITS

- SEE 10 COUNT 3/8" BOLT KITS ON PAGES 6 & 7
- STOCK EXHAUST:

HEX HEAD	6-3962	22.00
SIX POINT - HIGH STRENGTH	6-3963	97.75

ENGINE MOUNT KITS -FOR CAST FRONT MOUNT

SIX POINT - HIGH STRENGTH	6-3965	33.50
-FOR SIDE MOUNTS: 6 PT - HIGH STRENGTH	6-3975	46.75

CARB MOUNT KITS - SEE PAGE 7

FAN PULLEY KITS

SIX POINT - HIGH STRENGTH	#6-3971	\$18.50
TWELVE POINT - HIGH STRENGTH	6-3972	19.25

HARMONIC BALANCER KIT - WITH BILLET WASHER

SIX POINT - HIGH STRENGTH	6-3976	51.00
---------------------------	--------	-------

STARTER KITS

HEX HEAD	6-3967	6.00
SOCKET HEAD	6-3968	7.50
SIX POINT - HIGH STRENGTH	6-3969	18.25
TWELVE POINT - HIGH STRENGTH	6-3970	20.25

**ENGINE KITS FOR
SMALL BLOCK MOPAR**
273-318-340-360
CHRYSLER/DODGE/PLYMOUTH

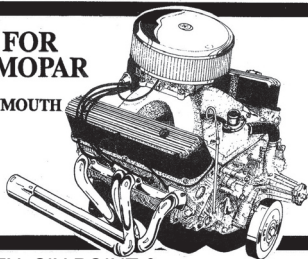

KITS FOR SMALL BLOCK MOPAR

Each engine kit includes component kits for the Distributor, Fuel Pump, Intake, Oil Pan, Thermostat, Valve Covers, and Water Pump.

* NOTE INDENTED HEX, SIX POINT & TWELVE POINT BOLTS ARE MADE IN USA *

FOR ENGINES WITH
CAST VALVE COVERS

FOR ENGINES WITH SHEET
METAL VALVE COVERS

PRICE:

ENGINE KITS FOR 273 - 318 - 340 - UP THRU 1991 - 360 - UP THRU 1992

	FOR ENGINES WITH CAST VALVE COVERS	FOR ENGINES WITH SHEET METAL VALVE COVERS	PRICE:
BUTTON & SOCKET HEAD	# 6-3033	# 6-3000	\$ 72.75
HEX/INDENTED HEX - ORIGINAL STYLE	6-3246	6-3241	78.00
SOCKET HEAD	6-3234	6-3002	79.00
SIX POINT - POLISHED - HIGH STRENGTH	6-3094	6-3213	297.50
TWELVE POINT - POLISHED - HIGH STRENGTH	6-3237	6-3214	316.75

ENGINE KITS FOR 5.2L (318, 1992 & UP) & 5.9L (360, 1993 & UP) FUEL INJECTED

BUTTON & SOCKET HEAD	6-3250	6-3256	79.00
INDENTED HEX HEAD - ORIGINAL STYLE	6-3252	6-3258	91.75
SOCKET HEAD	6-3253	6-3259	87.00
SIX POINT - POLISHED - HIGH STRENGTH	6-3254	6-3262	355.00
TWELVE POINT - POLISHED - HIGH STRENGTH	6-3255	6-3263	367.50

ACCESSORY KITS - (NOT INCLUDED IN THE ENGINE KIT)

BELLHOUSING KITS

SIX POINT - HIGH STRENGTH	# 6-3091	\$ 52.00
TWELVE POINT - HIGH STRENGTH	6-3218	53.25

ENGINE MOUNT KITS - FRONT CORNER

TYPE MOUNTS WITH 7/16" BOLTS		
SIX POINT - HIGH STRENGTH	6-3032	54.25
TWELVE POINT - HIGH STRENGTH	6-3219	57.00

ENGINE MOUNTS - CENTER OF BLOCK TYPE

MOUNTS WITH 3/8" BOLTS		
SIX POINT - HIGH STRENGTH	6-3832	30.00
TWELVE POINT - HIGH STRENGTH	6-3833	31.50

FAN PULLEY KITS

SIX POINT - HIGH STRENGTH	6-3030	16.75
TWELVE POINT - HIGH STRENGTH	6-3031	17.50

CARB MOUNT KITS -SEE PAGE 7

CRANK PULLEY KITS

SIX POINT - HIGH STRENGTH	# 6-3220	\$ 23.25
TWELVE POINT - HIGH STRENGTH	6-3221	24.50

EXHAUST BOLT KITS

-SEE 12 COUNT 5/16" BOLT KITS ON PAGES 6 & 7

STARTER KITS

HEX HEAD	6-3034	6.00
SOCKET HEAD	6-3035	8.00
SIX POINT - HIGH STRENGTH	6-3244	18.50
TWELVE POINT - HIGH STRENGTH	6-3245	19.75

FUEL INJECTOR KIT - BOTTOM PLATE WITH

WEDGE LOCK WASHERS	6-3834	36.00
--------------------	--------	-------

**ENGINE
KITS FOR
BIG BLOCK
MOPAR**
383-413-426-440

CHRYSLER/DODGE
PLYMOUTH

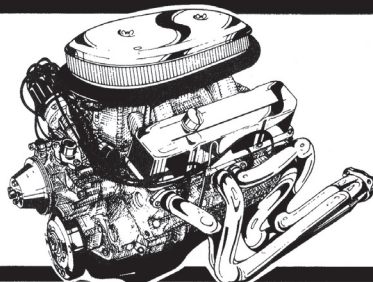

KITS FOR BIG BLOCK MOPAR

383 - 413 - 426 - 440

Each engine kit includes component kits for the Distributor, Fuel Pump, Intake, Oil Pan, Thermostat, Timing Cover, Valley Cover, Valve Covers, and Water Pump.

* NOTE INDENTED HEX, SIX POINT & TWELVE POINT BOLTS ARE MADE IN USA *

FOR ENGINES WITH
CAST VALVE COVERS

FOR ENGINES WITH SHEET
METAL VALVE COVERS

PRICE:

BUTTON & SOCKET HEAD	# 6-3140	# 6-3050	\$ 62.00
HEX/INDENTED HEX - ORIGINAL STYLE	6-3146	6-3142	79.00
SOCKET HEAD	6-3134	6-3052	75.50
SIX POINT - POLISHED - HIGH STRENGTH	6-3339	6-3138	322.50
TWELVE POINT - POLISHED - HIGH STRENGTH	6-3123	6-3139	346.00

ACCESSORY KITS - (NOT INCLUDED IN THE ENGINE KIT)

BELLHOUSING KITS

SIX POINT - HIGH STRENGTH	# 6-3093	\$ 39.25
TWELVE POINT - HIGH STRENGTH	6-3137	41.75

CARB MOUNT KITS -SEE PAGE 7

CRANK PULLEY KITS

SIX POINT - HIGH STRENGTH	6-3229	23.25
TWELVE POINT - HIGH STRENGTH	6-3230	24.50

FAN PULLEY KITS

SIX POINT - HIGH STRENGTH	6-3030	16.75
TWELVE POINT - HIGH STRENGTH	6-3031	17.50

ENGINE MOUNT KITS - FOR 'B' BODY CARS:

SIX POINT - HIGH STRENGTH	# 6-3148	\$ 74.75
TWELVE POINT - HIGH STRENGTH	6-3149	76.50

EXHAUST BOLT KITS

-SEE 12 COUNT 3/8" BOLT KITS ON PAGES 6 & 7

STARTER KITS

HEX HEAD	6-3081	6.00
SOCKET HEAD	6-3082	8.00
SIX POINT - HIGH STRENGTH	6-3244	18.50
TWELVE POINT - HIGH STRENGTH	6-3245	19.75

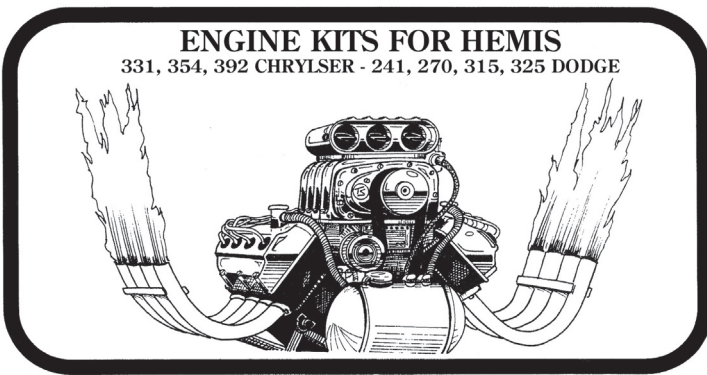

ENGINE KITS FOR HEMIS

331, 354, 392 CHRYSLER - 241, 270, 315, 325 DODGE

ENGINE KITS FOR ²⁷

EARLY HEMI

**331 - 354 - 392 CHRYSLER
241 - 270 - 315 - 325 DODGE**

Each engine kit includes component kits for the Cross Log-Water Manifold, Distributor, Fuel Pump, Intake, Oil Pan, Thermostat, Timing Cover, Valley Cover, Valve Covers, and Water Pump.

* NOTE INDENTED HEX, SIX POINT & TWELVE POINT BOLTS ARE MADE IN USA *

FOR ENGINES WITH CAST VALVE COVERS

FOR ENGINES WITH SHEET METAL VALVE COVERS

PRICE:

331/354/392 WITH CAST IRON INTAKES - WITH SINGLE 4 BARREL

BUTTON & SOCKET HEAD	# 6-3290	\$ 99.00
INDENTED HEX/HEX HEAD - ORIGINAL STYLE with Valve Cover Studs	6-3292	151.00
SOCKET HEAD	6-3293	107.00
SIX POINT - POLISHED - HIGH STRENGTH	6-3294	429.50
TWELVE POINT - POLISHED - HIGH STRENGTH	6-3295	457.75

331/354/392 WITH ALUMINUM INTAKES (2 1/4" LONG BOLTS)

BUTTON HEAD	# 6-3342	6-3296	94.50
HEX HEAD	6-3343	6-3297	88.75
SOCKET HEAD	6-3344	6-3299	105.50
SIX POINT - POLISHED - HIGH STRENGTH	6-3345	6-3340	427.75
TWELVE POINT - POLISHED - HIGH STRENGTH	6-3346	6-3341	451.00

241/270 DODGE WITH ALUMINUM INTAKES (1 1/2" LONG BOLTS)

BUTTON & SOCKET HEAD	6-3285	88.00
HEX HEAD	6-3286	88.00
SOCKET HEAD	6-3287	97.00
SIX POINT - POLISHED - HIGH STRENGTH	6-3288	417.00
TWELVE POINT - POLISHED - HIGH STRENGTH	6-3289	432.25

315/325 DODGE WITH ALUMINUM INTAKES (2" LONG BOLTS)

BUTTON & SOCKET HEAD	6-3265	94.00
HEX HEAD	6-3266	88.00
SOCKET HEAD	6-3267	106.00
SIX POINT - POLISHED - HIGH STRENGTH	6-3268	420.50
TWELVE POINT - POLISHED - HIGH STRENGTH	6-3269	438.50

ACCESSORY KITS (NOT INCLUDED IN THE ENGINE KIT)

ENGINE MOUNT KITS

SIX POINT - HIGH STRENGTH	# 6-3397	\$ 31.75
TWELVE POINT - HIGH STRENGTH	6-3398	33.25

EXHAUST BOLT KITS

-SEE 14 COUNT BOLT KITS ON PAGES 6 & 7

HARMONIC BALANCER KIT - WITH H.D. WASHER

SIX POINT - HIGH STRENGTH	# 6-3264	\$ 63.50
---------------------------	----------	----------

HARMONIC BALANCER KIT FOR BIG BLOCK

(383-440) MOPAR & 426 HEMI:

SIX POINT - HIGH STRENGTH	6-3325	67.50
---------------------------	--------	-------



Early hemi rail at the York US-30 strip



This was my first car - bought it for \$35 off of this guy's grandson back in 1971. I later traded it for a box of tools, but that's another story. If I still had it, I would have to stuff an early hemi into it!

**T.O.T.A.L.L.Y.
STAINLESS**

TOLL FREE ORDER LINE : 1-800-767-4781

KITS FOR 426 HEMI ENGINES

ENGINE KITS- Every engine kit includes component kits for the Distributor, Fuel Pump, Intake, Oil Pan, Thermostat, Timing Cover, Valve Covers, and Water Pump.

* NOTE INDENTED HEX, SIX POINT & TWELVE POINT BOLTS ARE MADE IN USA *	FOR ENGINES WITH CAST VALVE COVERS	FOR ENGINES WITH SHEET METAL VALVE COVERS	PRICE:
BUTTON & SOCKET HEAD	# 6-3326	# 6-3325	\$ 62.50
INDENTED HEX/HEX HEAD - ORIGINAL STYLE	6-3331	6-3300	70.25
SOCKET HEAD	6-3332	6-3302	67.00
SIX POINT - POLISHED - HIGH STRENGTH	6-3333	6-3303	289.75
TWELVE POINT - POLISHED - HIGH STRENGTH	6-3334	6-3304	323.75

ACCESSORY KITS (NOT INCLUDED IN THE ENGINE KIT)

BELLOUSING KITS

SIX POINT - HIGH STRENGTH	# 6-3321	\$ 45.75
TWELVE POINT - HIGH STRENGTH	6-3324	48.25

EXHAUST BOLT KITS- SEE PAGES 6 & 7

CARB MOUNT KITS - SEE PAGE 7

ENGINE MOUNT KITS

SIX POINT - HIGH STRENGTH	# 6-3322	\$ 34.00
TWELVE POINT - HIGH STRENGTH	6-3323	35.50

KITS FOR LATE MODEL HEMI ENGINES

BELLOUSING KITS

SIX POINT - HIGH STRENGTH	# 5-5750	\$ 43.75
TWELVE POINT - HIGH STRENGTH	5-5751	45.00

EXHAUST BOLT KITS

-SEE 17 COUNT 3/8" BOLT KITS ON PAGES 6 & 7

AC/ALTERNATOR/POWER STEERING KITS

SOCKET HEAD	# 5-5717	\$ 29.75
SIX POINT - HIGH STRENGTH	5-5718	113.50
TWELVE POINT - HIGH STRENGTH	5-5719	119.75

KITS FOR SLANT 6 ENGINES

Each engine kit includes component kits for the Distributor, Fuel Pump, Intake to Exhaust, Intake & Exhaust to Heads, Oil Filter, Oil Pan, Thermostat, Timing Cover, Valve Cover, and Water Pump.

* NOTE INDENTED HEX, SIX POINT & TWELVE POINT BOLTS ARE MADE IN USA *	FOR ENGINES WITH CAST VALVE COVERS	FOR ENGINES WITH SHEET METAL VALVE COVERS	PRICE:
BUTTON HEAD	# 6-3600	# 6-3665	\$ 78.50
INDENTED HEX/HEX HEAD - STOCK SYLE		6-3602	105.50
SOCKET HEAD	6-3603	6-3667	89.00
SIX POINT - POLISHED - HIGH STRENGTH	6-3604	6-3668	361.75
TWELVE POINT - POLISHED - HIGH STRENGTH	6-3605	6-3669	380.25

ACCESSORY KITS (NOT INCLUDED IN THE ENGINE KIT)

BELLOUSING KITS

SIX POINT - HIGH STRENGTH	# 6-3321	\$ 45.75
TWELVE POINT - HIGH STRENGTH	6-3324	48.25

STARTER KITS

HEX HEAD	6-3081	6.00
SIX POINT - HIGH STRENGTH	6-3244	18.50
TWELVE POINT - HIGH STRENGTH	6-3245	19.75

FAN PULLEY KITS

SIX POINT - HIGH STRENGTH	6-3030	16.75
TWELVE POINT - HIGH STRENGTH	6-3031	17.50

KITS FOR PONTIAC OVERHEAD CAM 6 CYL

Each engine kit includes component kits for the Distributor, Fuel Pump, Intake (1 barrel intake kit contains heavy washers & six point bolts), Oil Filter, Oil Pan, Thermostat, Timing Cover, Valve Covers, & Water Pump.

BUTTON HEAD & SIX POINT	6-6440	\$214.00
INDENTED HEX & HEX HEAD - ORIGINAL STYLE & SIX POINT	6-6441	259.50
SOCKET HEAD & SIX POINT	6-6442	216.00
SIX POINT - POLISHED - HIGH STRENGTH	6-6443	451.50
TWELVE POINT- POLISHED - HIGH STRENGTH	6-6444	479.50

ACCESSORY KITS (NOT INCLUDED IN THE ENGINE KIT)

FAN PULLEY KITS - 3/4" LONG BOLTS

-STEEL PULLEYS WITHOUT A SPACER:		
SIX POINT - HIGH STRENGTH	6-5609	17.50
TWELVE POINT - HIGH STRENGTH	6-5607	18.25

BELLOUSING KITS - SEE PAGE 29

CARB MOUNT KITS - SEE PAGE 7

TRANSMISSION KITS

Automatic and Manual

GM - FORD - MOPAR

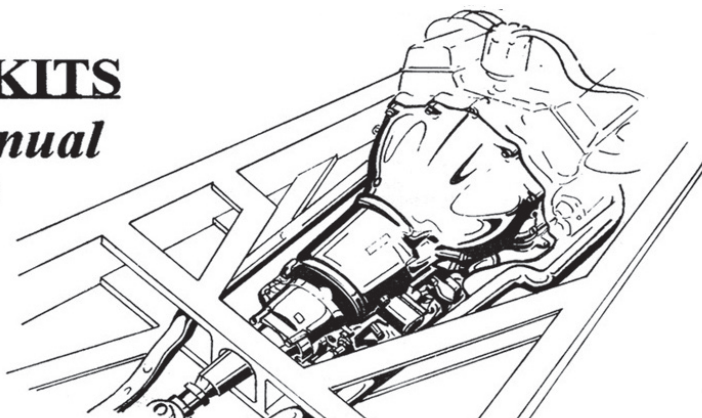

BASE KITS FOR GM HYDROMATICS

-INCLUDES BOLTS & WASHERS FOR: BELL HOUSING, DUST COVER, VACUUM MODULATOR, SHIFT LEVER, SIDE COVER (400), TAIL SHIFT, & SPEEDOMETER HOUSING *ORDER PAN KIT SEPARATELY*

-POWERGLIDE

BUTTON & SIX POINT	# 6-6900	\$ 88.25
HEX & SIX POINT	6-6901	88.75
SOCKET & SIX POINT	6-6902	89.00
SIX POINT - HIGH STRENGTH	6-6903	100.00
TWELVE POINT - HIGH STRENGTH	6-6904	107.50

-350 TURBO - ALL BOLTS ARE US THREAD

BUTTON & SIX POINT	6-6905	70.25
HEX & SIX POINT	6-6906	71.00
SOCKET & SIX POINT	6-6907	71.50
SIX POINT - HIGH STRENGTH	6-6908	89.50
TWELVE POINT - HIGH STRENGTH	6-6909	93.50

-350 TURBO - BOLTS ARE METRIC & US

BUTTON & SOCKET	6-6910	62.00
HEX HEAD	6-6911	63.00
SOCKET HEAD	6-6925	63.00
SIX POINT - HIGH STRENGTH	6-6923	90.75
TWELVE POINT - HIGH STRENGTH	6-6924	95.75

-400 TURBO

BUTTON & SIX POINT	6-6913	91.25
HEX & SIX POINT	6-6914	96.50
SOCKET & SIX POINT	6-6915	96.75
SIX POINT - HIGH STRENGTH	6-6916	112.75
TWELVE POINT - HIGH STRENGTH	6-6917	118.00

-700 R-4 WITH US THREAD BELL HOUSING BOLTS AND 6MM DUST COVER BOLTS

BUTTON HEAD	6-6918	62.25
HEX HEAD	6-6919	59.50
SOCKET HEAD	6-6920	73.75
SIX POINT - HIGH STRENGTH	6-6921	113.50
TWELVE POINT - HIGH STRENGTH	6-6922	122.00

-700 R-4/4L60 - WITH US THREAD BELL HOUSING BOLTS AND 10MM DUST COVER BOLTS

BUTTON HEAD	5-1725	65.75
HEX HEAD	5-1726	61.25
SOCKET HEAD	5-1727	64.75
SIX POINT - HIGH STRENGTH	5-1728	120.00
TWELVE POINT - HIGH STRENGTH	5-1729	128.00

-4L80 - WITH US THREAD BELL HOUSING BOLTS

BUTTON HEAD	5-1715	60.75
HEX HEAD	5-1716	62.75
SOCKET HEAD	5-1717	63.00
SIX POINT - HIGH STRENGTH	5-1718	142.25
TWELVE POINT - HIGH STRENGTH	5-1719	150.25

-4L80 - ALL METRIC

BUTTON HEAD	5-1720	58.00
HEX HEAD	5-1721	55.50
SOCKET HEAD	5-1722	61.00
SIX POINT - HIGH STRENGTH	5-1723	156.50
TWELVE POINT - HIGH STRENGTH	5-1724	163.25

BELL HOUSING KITS FOR GM

-1 1/4" LONG (US) FOR CAST IRON BELL HOUSINGS

SIX POINT - HIGH STRENGTH	# 6-5145	\$ 29.50
TWELVE POINT - HIGH STRENGTH	6-5146	31.00

-1 1/2" LONG (US) FOR ALUMINUM BELL HOUSINGS INCLUDED IN BASE TRANSMISSION KITS

SIX POINT - HIGH STRENGTH	6-5180	41.75
TWELVE POINT - HIGH STRENGTH	6-5181	43.75

- METRIC 5 BOLT TYPE (LS ENGINES):

SIX POINT - HIGH STRENGTH	5-1574	46.00
TWELVE POINT - HIGH STRENGTH	5-1575	47.75

- METRIC 7 BOLT TYPE (LS ENGINES):

SIX POINT - HIGH STRENGTH	5-1582	64.25
TWELVE POINT - HIGH STRENGTH	5-1583	67.25

- METRIC 8 BOLT TYPE (LS ENGINES):

SIX POINT - HIGH STRENGTH	5-1598	73.25
TWELVE POINT - HIGH STRENGTH	5-1599	76.50

PAN KITS FOR HYDROMATICS

- NOT INCLUDED IN BASE TRANSMISSION KITS -

-P-GLIDE & 350-400 CAST ALUMINUM PANS

BUTTON HEAD	6-5503	9.00
HEX HEAD	6-5504	10.00
SOCKET HEAD	6-5505	10.25
SIX POINT - HIGH STRENGTH	6-5526	51.25
TWELVE POINT - HIGH STRENGTH	6-5527	54.50

-P-GLIDE & 350-400 SHEET METAL -STOCK OR CHROME

BUTTON HEAD	6-5506	8.50
HEX HEAD	6-5507	9.75
INDENTED HEX	6-5546	11.50
SOCKET HEAD	6-5508	10.00
SIX POINT - HIGH STRENGTH	6-5528	47.00
TWELVE POINT - HIGH STRENGTH	6-5529	49.25

-4L60/4L65/700 R-4 CAST ALUMINIUM PAN

BUTTON HEAD	6-5556	10.50
HEX HEAD	6-5557	10.50
SOCKET HEAD	6-5588	11.00
SIX POINT - HIGH STRENGTH	6-5589	81.00
TWELVE POINT - HIGH STRENGTH	6-5590	86.50

-4L60/4L65/700 R-4 SHEET METAL - STOCK OR CHROME

BUTTON HEAD	6-5553	10.00
HEX HEAD	6-5554	10.50
SOCKET HEAD	6-5555	10.75
SIX POINT - HIGH STRENGTH	6-5591	78.00
TWELVE POINT - HIGH STRENGTH	6-5592	83.75

-4L80 CAST ALUMINIUM PAN

BUTTON HEAD	5-1705	14.00
HEX HEAD	5-1706	13.50
SOCKET HEAD	5-1707	14.50
SIX POINT - HIGH STRENGTH	5-1708	95.75
TWELVE POINT - HIGH STRENGTH	5-1709	99.75

-4L80 SHEET METAL - STOCK OR CHROME

BUTTON HEAD	5-1710	11.00
HEX HEAD	5-1711	11.25
SOCKET HEAD	5-1712	13.50
SIX POINT - HIGH STRENGTH	5-1713	85.50
TWELVE POINT - HIGH STRENGTH	5-1714	90.50

SEE NEXT PAGE FOR KITS FOR FORD & MOPAR

TRANSMISSION KITS (CONTINUED)

BASE KITS FOR AOD, C-4/6 TRANSMISSIONS

AOD: INCLUDES BOLTS & WASHERS FOR: DUST COVER, REAR MOUNT, TAIL SHAFT, LINKAGE MOUNT, & SHIFTER ELECTRONICS. *ORDER BELL HOUSING & PAN KITS SEPARATELY*

BUTTON & SIX POINT	# 5-4500	\$ 54.00
HEX & SIX POINT	5-4501	51.50
SOCKET & SIX POINT	5-4502	56.50
SIX POINT - HIGH STRENGTH	5-4503	95.00
TWELVE POINT - HIGH STRENGTH	5-4504	101.75

C4: INCLUDES BOLTS & WASHERS FOR: DUST COVER, TRANSMISSION TO BELLHOUSING, REAR MOUNT, TAIL SHAFT, & SPEEDO CABLE. *ORDER PAN & BELLHOUSING KITS SEPARATELY*

BUTTON & SIX POINT	6-2900	72.75
HEX & SIX POINT	6-2901	73.75
SOCKET & SIX POINT	6-2902	75.00
SIX POINT - HIGH STRENGTH	6-2903	87.00
TWELVE POINT - HIGH STRENGTH	6-2904	89.75

C6: INCLUDES BOLTS & WASHERS FOR: DUST COVER, NEUTRAL SHIFT, REAR MOUNT, SIDE PLATE, TAIL SHAFT, & SPEEDOMETER HOUSING. *ORDER BELLHOUSING & PAN KITS SEPARATELY*

BUTTON & SIX POINT	6-0914	66.25
HEX & SIX POINT	6-0915	67.00
SOCKET & 6 POINT	6-0916	67.75
SIX POINT - HIGH STRENGTH	6-0943	103.50
TWELVE POINT - HIGH STRENGTH	6-0944	109.50

PAN KITS FOR AOD, C-4 & C-6

--AOD CAST ALUMINIUM PANS

BUTTON HEAD	5-4512	10.50
HEX HEAD	5-4513	10.50
SOCKET HEAD	5-4514	10.50
SIX POINT - HIGH STRENGTH	5-4515	70.25
TWELVE POINT - HIGH STRENGTH	5-4516	75.00

-AOD SHEET METAL- STOCK OR CHROME PANS

BUTTON HEAD	5-4506	10.25
HEX HEAD	5-4507	10.00
SOCKET HEAD	5-4509	10.50
SIX POINT - HIGH STRENGTH	5-4510	68.50
TWELVE POINT - HIGH STRENGTH	5-4511	73.75

-C-4 CAST ALUMINIUM PANS

BUTTON HEAD	6-0900	8.50
HEX HEAD	6-0901	9.50
SOCKET HEAD	6-0902	9.75
SIX POINT - HIGH STRENGTH	6-0917	42.50
TWELVE POINT - HIGH STRENGTH	6-0918	45.25

-C-4 SHEET METAL- STOCK OR CHROME PANS

BUTTON HEAD	6-0903	8.50
HEX HEAD	6-0904	9.00
INDENTED HEX HEAD	6-0928	11.00
SOCKET HEAD	6-0905	9.50
SIX POINT - HIGH STRENGTH	6-0919	41.25
TWELVE POINT - HIGH STRENGTH	6-0920	45.50

-C-6 CAST ALUMINIUM PANS

BUTTON HEAD	6-0906	11.50
HEX HEAD	6-0907	13.00
SOCKET HEAD	6-0908	13.25
SIX POINT - HIGH STRENGTH	6-0921	66.00
TWELVE POINT - HIGH STRENGTH	6-0922	70.25

-C-6 SHEET METAL - STOCK OR CHROME PANS

BUTTON HEAD	6-0909	11.00
HEX HEAD	6-0910	12.50
SOCKET HEAD	6-0911	12.75
SIX POINT - HIGH STRENGTH	6-0923	62.25
TWELVE POINT - HIGH STRENGTH	6-0924	68.50

BELLHOUSING KITS FOR FORDS C4/6

- SEE THE ACCESSORY SECTIONS FOR FORD ENGINE: PAGES 13-14



BASE KITS FOR 727 TORQUEFLITE

-INCLUDES FASTENERS FOR: DUST COVER TAIL SHIFT, & SPEEDOMETER CLAMP. * ORDER BELLHOUSING & PAN KITS SEPARATELY*

BUTTON HEAD	# 6-3100	\$ 41.00
HEX HEAD	6-3101	42.00
SOCKET HEAD	6-3102	43.00
SIX POINT - HIGH STRENGTH	6-3127	59.00
TWELVE POINT - HIGH STRENGTH	6-3128	63.25

BELLHOUSING KITS FOR TORQUEFLITES

-REFER TO INDEX FOR SPECIFIC ENGINE APPLICATION. BELLHOUSING KITS ARE LISTED WITH THE ACCESSORY KITS AT THE END OF EACH ENGINE SECTION

PAN KITS FOR 727 & 904

-CAST ALUMINIUM PANS

BUTTON HEAD	# 6-3103	\$ 10.00
HEX HEAD	6-3104	11.25
SOCKET HEAD	6-3105	11.50
SIX POINT - HIGH STRENGTH	6-3129	52.25
TWELVE POINT - HIGH STRENGTH	6-3130	55.25

-SHEET METAL -STOCK OR CHROME PAN

BUTTON HEAD	6-3106	9.75
HEX HEAD	6-3107	10.75
INDENTED HEX- ORIGINAL STYLE	6-3133	12.00
SOCKET HEAD	6-3108	11.50
SIX POINT - HIGH STRENGTH	6-3131	53.75
TWELVE POINT - HIGH STRENGTH	6-3132	56.75

MANUAL TRANSMISSION KITS

-KIT FOR BORG-WARNER T-10 SIDE COVER

BUTTON HEAD	# 6-5560	\$ 7.00
HEX HEAD	6-5561	7.50
SOCKET HEAD	6-5562	7.75
SIX POINT - HIGH STRENGTH	6-5563	35.50
TWELVE POINT - HIGH STRENGTH	6-5564	37.50

-KIT FOR MUNCIE SIDE COVER

BUTTON HEAD	6-5565	6.00
HEX HEAD	6-5566	6.50
SOCKET HEAD	6-5567	6.75
SIX POINT - HIGH STRENGTH	6-5568	26.00
TWELVE POINT - HIGH STRENGTH	6-5569	36.00

- KIT FOR TREMEC TKO 5 SPEED: 74 pc kits

BUTTON HEAD	5-4800	102.75
HEX HEAD	5-4801	103.00
SOCKET HEAD	5-4802	104.00
SIX POINT - HIGH STRENGTH	5-4803	200.25
TWELVE POINT - HIGH STRENGTH	5-4804	205.25

- KIT FOR TREMEC T56 6 SPEED:

US THREADS:

SIX POINT - HIGH STRENGTH	5-4858	190.50
TWELVE POINT - HIGH STRENGTH	5-4859	196.00

METRIC THREADS:

SIX POINT - HIGH STRENGTH	5-4860	190.75
TWELVE POINT - HIGH STRENGTH	5-4861	192.50

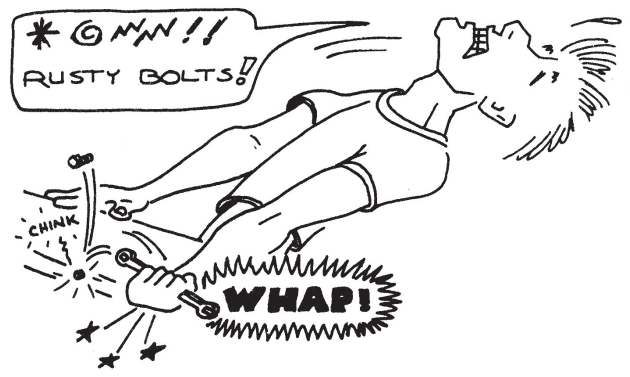

OIL PAN & REAR END PLUGS

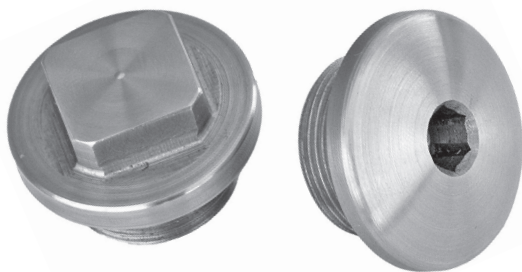

WE MAKE THESE IN OUR SHOP FROM STAINLESS BAR STOCK - THEY LOOK GREAT AND THE BUTTON HEAD PLUGS ARE LOW PROFILE SO YOU WON'T SNAG A PLUG!

FOR STANDARD PIPE PLUGS SEE PAGE 146

OIL PAN PLUGS: SUPER LOW PROFILE!

1/2-20 BUTTON HEAD (3/4" OD FLANGE) # 7-0402 \$ 21.00

12MM PLUGS FOR CHEVY LS ENGINES - SEE PAGE 20

PLUGS FOR DIFFERENTIALS:

5/8-18: (1" OD FLANGE) (FOR SOME 9" FORD DIFFERENTIALS)
 BUTTON HEAD 7-0403 24.75
 SQUARE FLANGE HEAD 7-0404 33.50

3/4-16: (1 1/8" OD FLANGE) (FOR SOME 9" FORD DIFFERENTIALS)
 BUTTON HEAD 7-0405 27.75
 SQUARE FLANGE HEAD 7-0406 40.50

7/8-18 (1 " OD FLANGE)
 BUTTON HEAD 7-0414 24.75

1-20 (1 3/8" OD FLANGE) FOR 1950'S GM CARS & TRUCKS
 BUTTON HEAD 7-0401 35.25
 SQUARE FLANGE HEAD - ORIGINAL STYLE 7-0400 46.75

16-1.5 MM PLUG
 BUTTON HEAD (1" OD FLANGE) 7-0413 24.75

22.5 MM PLUGS FOR GM 4X4 TRANSFER CASES
 BUTTON HEAD (1 1/4" OD FLANGE) 7-0407 31.50

1/2" STRAIGHT PIPE THREAD (1 1/4" OD FLANGE) (FOR '56-'66 BOP)
 BUTTON HEAD 7-0409 35.25
 SQUARE FLANGE HEAD - ORIGINAL STYLE 7-0410 45.00

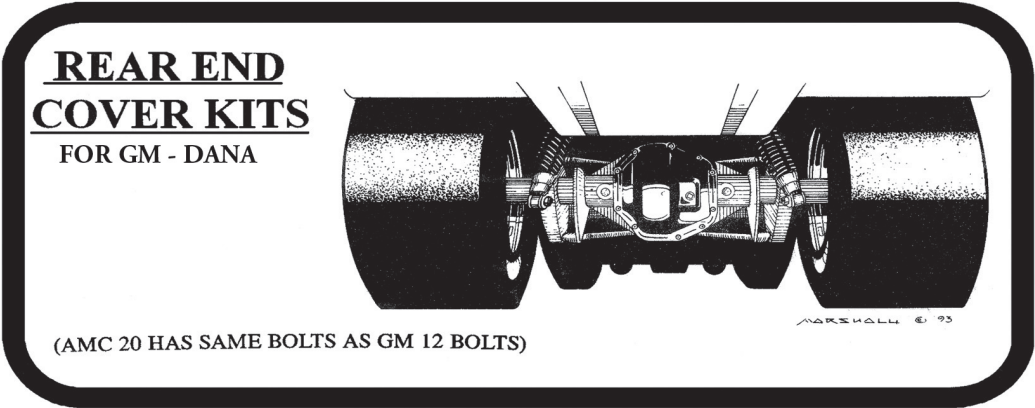

REAR COVER KITS FOR GM

-10 BOLT REAR COVER KITS-CAST ALUMINIUM
 BUTTON HEAD 6-5509 8.00
 HEX HEAD 6-5510 9.00
 SOCKET HEAD 6-5511 9.50
 SIX POINT - HIGH STRENGTH 6-5532 42.50
 TWELVE POINT - HIGH STRENGTH 6-5533 44.50

-10 BOLT REAR COVER KITS-SHEET METAL (STOCK, CHROMED, OR ANODIZED)
 BUTTON HEAD 6-5512 7.75
 HEX HEAD 6-5513 8.50
 INDENTED HEX- ORIGINAL STYLE 6-5537 10.75
 SOCKET HEAD 6-5514 9.00
 SIX POINT - HIGH STRENGTH 6-5535 39.50
 TWELVE POINT - HIGH STRENGTH 6-5536 41.75

-12 BOLT REAR COVER KITS-CAST ALUMINIUM
 BUTTON HEAD 6-5515 9.00
 HEX HEAD 6-5516 10.00
 SOCKET HEAD 6-5517 10.50
 SIX POINT - HIGH STRENGTH 6-5545 50.50
 TWELVE POINT - HIGH STRENGTH 6-5538 52.75

-12 BOLT REAR COVER KITS-SHEET METAL (STOCK, CHROMED, OR ANODIZED)
 BUTTON HEAD 6-5518 8.75
 HEX HEAD 6-5519 9.50
 INDENTED HEX- ORIGINAL STYLE 6-5541 11.00
 SOCKET HEAD 6-5549 10.50
 SIX POINT - HIGH STRENGTH 6-5539 45.75
 TWELVE POINT - HIGH STRENGTH 6-5540 49.50

REAR COVER KITS FOR DANA

-DANA 30/44 REAR COVER KITS-SHEET METAL (STOCK, CHROMED, OR ANODIZED) 5/16-18 BOLTS
 BUTTON HEAD 6-3109 7.00
 HEX HEAD 6-3110 7.75
 INDENTED HEX-ORIGINAL STYLE 6-3120 10.00
 SOCKET HEAD 6-3111 8.50
 SIX POINT - HIGH STRENGTH 6-3118 40.50
 TWELVE POINT - HIGH STRENGTH 6-3119 42.75

-DANA 60 REAR COVER KITS-CAST ALUMINIUM -3/8-16 BOLTS
 BUTTON HEAD 6-3112 10.00
 HEX HEAD 6-3113 11.00
 INDENTED HEX-ORIGINAL STYLE 6-3189 13.50
 SOCKET HEAD 6-3114 12.25
 SIX POINT - HIGH STRENGTH 6-3121 44.50
 TWELVE POINT - HIGH STRENGTH 6-3122 48.00

-DANA 60 REAR COVER KITS-SHEET METAL
 BUTTON HEAD 6-3115 9.00
 HEX HEAD 6-3116 10.25
 INDENTED HEX- ORIGINAL STYLE 6-3126 12.75
 SOCKET HEAD 6-3117 11.25
 SIX POINT - HIGH STRENGTH 6-3124 42.25
 TWELVE POINT - HIGH STRENGTH 6-3125 45.75

KITS FOR FORD 9" 'CHUNK' (GEAR SECTOR):
 NYLON INSERT LOCK NUTS & WASHERS 6-3150 7.00
 TALL ACORN NUTS & LOCK WASHERS 6-3151 32.00

AFTERMARKET SUSPENSION KITS

ALL SUSPENSION KITS USE US MADE HIGH STRENGTH SIX POINT BOLTS -

1/2" AND SMALLER SIZES ARE MADE BY ARP, THE LARGER SIZES WE HAVE CUSTOM MADE FROM HEAT TREATED 17-4 PH STAINLESS. WE HAVE U-BOLTS, TALL NUTS AND MANY OF THE WASHERS CUSTOM MADE.

KITS INCLUDE GREASE FITTINGS AND COTTER KEYS IF NEEDED, BUT NOT SLOTTED TALL (CASTLE) NUTS. THE HEIGHT OF CASTLE NUTS IS DETERMINED BY THE MANUFACTURER OF THE BALL JOINTS/TIE ROD ENDS. WE STOCK TALL CASTLE NUTS AND CUT THEM TO YOUR HEIGHT - TO ORDER. SEE PAGE 130.

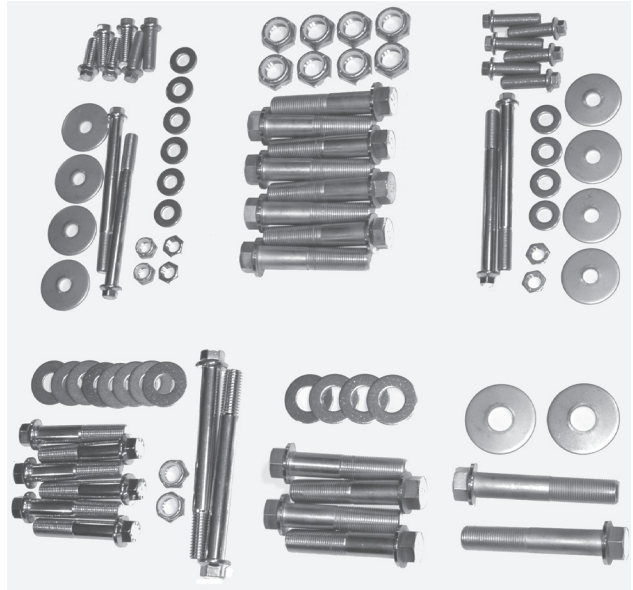

AFTERMARKET SUSPENSION KITS FOR:

ART MORRISON TRI-5 FRONT & REAR SUSPENSION - SHOWN IN PICTURE ABOVE -

SIX POINT - POLISHED

6-9100

\$ 837.25

DETROIT SPEED HYDROFORMED FRONT SUBFRAME SUSPENSION

SIX POINT - POLISHED

6-9120

476.00

DETROIT SPEED QUADRALINK REAR SUSPENSION

SIX POINT - POLISHED

6-9121

458.25

HEIDT'S SUSPENSION KITS - SIX POINT - POLISHED

SUPERIDE FRONT SUSPENSION (REAR STEER)

6-9172

289.75

SUPERIDE II (FRONT STEER) W/O SWAY BAR

6-9173

353.75

SUPERIDE II (FRONT STEER) WITH SWAY BAR

6-9177

353.75

INDEPENDENT REAR SUSPENSION -STREET ROD

6-9175

740.25

'PRO-G' FRONT SUSPENSION - SIX POINT

6-2897

529.25

* DOES NOT INCLUDE CASTLE NUTS *

'PRO-G' INDEPENDENT REAR - SIX POINT

6-2899

840.75

'PRO-G' INDEPENDENT REAR - TWELVE POINT

6-2895

1885.00

'PRO-G' FRAME ADAPTERS TO CAMARO SUB-FRAME

6-2898

92.50

JIM MEYER RACING PRODUCTS - G4 FOR 1955-57 CHEVY

FRONT SUSPENSION - SIX POINT - POLISHED

6-9161

707.00

REAR SUSPENSION - SIX POINT - POLISHED

6-9166

538.50

G3 FOR 62-72 CHEVY TRUCK

FRONT SUSPENSION - SIX POINT - POLISHED

6-9160

292.25

REAR LADDER BAR SUSPENSION - SIX PT - POLISHED

6-9165

485.50

MARTZ - A-BODY TUBE CHASSIS (FRONT & REAR SUSPENSION)

SIX POINT - POLISHED

6-9194

977.50

1934 OUTLAW CHASSIS KIT (FRONT & REAR SUSPENSION)

SIX POINT - POLISHED

6-9180

556.50

OZE SUSPENSION WITH AIR BAGS

SIX POINT - POLISHED

6-9190

874.00

AFTERMARKET SUSPENSION KITS

ALL SUSPENSION KITS USE US MADE HIGH STRENGTH BOLTS -

PETE & JAKE'S SUSPENSION KITS:

FOR FRONT SUSPENSION WITH TRANSVERSE SPRING & HAIR PIN RADIUS RODS:

SIX POINT - HIGH STRENGTH - POLISHED	# 6-9144	\$ 297.25
TWELVE POINT - HIGH STRENGTH - POLISHED	6-9145	302.25

FOR REAR SUSPENSION WITH TRANSVERSE SPRING & HAIR PIN LADDER BARS:

SIX POINT - HIGH STRENGTH - POLISHED	6-9146	310.50
TWELVE POINT - HIGH STRENGTH - POLISHED	6-9147	311.50

PROGRESSIVE AUTOMOTIVE FRONT SUSPENSION

SIX POINT - POLISHED	6-9130	434.75
----------------------	--------	--------

SCOTT'S SUSPENSION KITS - SIX POINT - POLISHED

FRONT STEER COIL OVER FRONT	6-9150	759.50
REAR STEER COIL OVER FRONT	6-9151	711.00
FRONT STEER AIR SHOCK FRONT	6-9152	725.00
REAR STEER AIR SHOCK FRONT	6-9153	674.50
COIL OVER REAR	6-9154	606.00
AIR SHOCK REAR	6-9155	608.00

TCI CHASSIS KIT FOR 1940 FORD - INCLUDES FRONT & REAR SUSPENSION, STEERING RACK, ENGINE MOUNTS, PROPORTIONING VALVE MOUNT, GREASE FITTINGS & COTTER PINS.

SIX POINT - POLISHED	6-4999	667.75
----------------------	--------	--------

TOTALLY STAINLESS KITS FOR AFTERMARKET C-4 CHASSIS * DOES NOT INCLUDE FRONT CALIPAR BOLTS

FRONT SUSPENSION - SIX POINT - POLISHED	5-1900	916.00
---	--------	--------

KITS FOR 1970-72 BUICK GS/SKYLARK

BODY KITS- Every Body Kit includes component kits for Bumpers & Brackets, Door Hinges, Door Latches & Strikers, Door Sills, Firewall, Front Body Mount (Core Support to Frame), Front Sheet Metal, Gas Tank, Glove Box, Headlight Mounting Screws, Hood Hinges, Hood Latch & Catch, Hood Assembly, Interior Trim Screws, Lens Screws, Radiator Support, Trunk Hinges, Trunk Latch & Catch, and Window Trim Screws.

BUTTON , FLAT SOCKET & SOCKET HEAD (CUSTOM STYLE)	# 6-2750	\$ 305.00
INDENTED HEX & PHILLIPS HEAD (OEM STYLE BOLTS)	6-2751	330.00
ORIGINAL STYLE - INDENTED HEX & PHILLIPS WITH BLACK STAINLESS (WHERE APPROPRIATE)	6-2752	365.00

ACCESSORY KITS: (NOT INCLUDED IN THE BODY KIT)

CHASSIS KIT - INCLUDES FRONT & REAR SUSPENSION, SWAY BARS, STEERING BOX, ENGINE MOUNTS & TRANSMISSION CROSS MEMBER - HIGH STRENGTH - "CASTLE" NUTS NOT INCLUDED - SEE PAGE 130

SIX POINT - POLISHED	# 6-8162	\$ 667.00
TWELVE POINT - POLISHED	6-2749	696.25

BODY MOUNT KITS - SUPPLEMENT TO FRONT MOUNT: (12 BOLTS & WASHERS)

HEX HEAD	6-1951	64.00
SOCKET HEAD	6-1952	92.00
SIX POINT - POLISHED	6-1953	142.25
TWELVE POINT - POLISHED	9-1349	148.50

DOOR STRIKERS KIT - SOCKET HEAD SHOULDER BOLTS WITH WASHERS

	6-8154	59.95
--	--------	-------

ENGINE KITS -SEE PAGE 17

ENGINE MOUNTS TO FRAME KITS

SIX POINT - POLISHED	6-1945	40.50
TWELVE POINT - POLISHED	6-1946	44.25

FRONT & REAR SUSPENSION KITS - HIGH

STRENGTH STAINLESS BOLTS, WITH KNURLED BOLTS & TALL NUTS, COMPLETE WITH ZERKS & COTTERS,

**CASTLE NUTS NOT INCLUDED - SEE PAGE 130*

SIX POINT - POLISHED	6-8157	499.00
TWELVE POINT - POLISHED	6-2745	514.25

REAR SHOCK MOUNT STUD KIT

17-4 PH - HIGH STRENGTH STUDS & NUTS # 6-8170 \$ 77.00

REAR SWAY BAR KIT

SIX POINT - POLISHED	6-8185	46.25
TWELVE POINT - POLISHED	6-8186	48.00

REAR COVER KITS - SEE PAGE 31

STEERING BOX COVER & MOUNT KITS

SIX POINT - POLISHED	6-1936	57.50
TWELVE POINT - POLISHED	6-1937	65.75

TRANSMISSION CROSSMEMBER KITS

SIX POINT - POLISHED	6-1768	35.25
TWELVE POINT - POLISHED	6-1771	37.50

TRANSMISSION KITS -SEE PAGE 29-30

WHEEL WELL MOULDING KIT

ORIGINAL STYLE - ROUND WASHER HEAD	6-1796	8.00
CUSTOM STYLE - BUTTON HEAD	6-1764	9.00

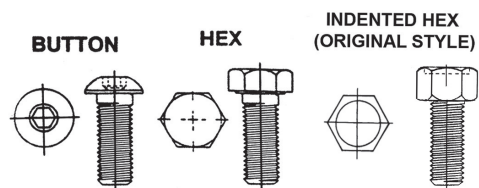

BODY KITS FOR CADILLACS

BODY KITS FOR 1955 CADILLAC:

- Every Body Kit includes component kits for Body Mounting, Bumpers & Brackets, Door Hinges, Door Jambs (Latches, Strikers & Door Sills), Firewall, Front Sheet Metal, Grill & Head lights, Hood Hinges, Hood Latch & Catch, Hood Moldings & Ornaments, Interior Trim Screws, Radiator Support & Horn, Rear panels & Quarter Molding Screws, Tail light Screws, Trunk Hinges, Trunk Latch & Catch, and Vent Window Screws.

KITS FOR CONVERTIBLES:

CUSTOM STYLE - BUTTON & FLAT SOCKET HEAD	# 6-6649	\$ 682.75
ORIGINAL STYLE - INDENTED HEX, HEX & PHILLIPS HEAD - 1090 PIECES	6-6651	660.00

KITS FOR SEDANS:

CUSTOM STYLE - BUTTON & FLAT SOCKET HEAD	6-6652	685.00
ORIGINAL STYLE - INDENTED HEX, HEX & PHILLIPS HEAD	6-6654	660.00

BODY KITS FOR: 1959-60 CADILLAC COUPE - 1398 PIECES!

- Every Body Kit includes component kits for Antenna, Body Mounting, Bumpers & Brackets, Door Hinges, Door Latches & Strikers, Door Sills, Firewall, Front Sheet Metal, Grill, Glove Box, Headlights Mounting Screws, Hood Hinges, Hood Latch & Catch, Hood Assembly, Interior Trim Screws, Lens Screws, License Plate, Radiator Support, Trunk Hinges, Trunk Latch & Catch, and Window Trim Screws.

CUSTOM STYLE - BUTTON & FLAT SOCKET HEAD	# 6-6798	\$ 625.00
ORIGINAL STYLE - INDENTED HEX, HEX & PHILLIPS HEAD	6-6799	730.00

ACCESSORY KITS: (NOT INCLUDED IN THE BODY KIT)

ENGINE KITS -SEE PAGE 18

BODY KITS FOR 1940-54 CHEVROLET

BODY KITS- Every Body Kit includes component kits for Body Mounting Core Support (1949-54 ONLY), Bumpers & Brackets, Door Hinges, Door Latches & Strikers, Door Sills, Door Straps, Firewall, Front Sheet Metal, Glove Box, Headlight Mounting Screws, Hood Hinges, Hood Latch & Catch, Hood Assembly, Interior Trim Screws, Lens Screws, Radiator Support, Trunk Hinges, Trunk Latch & Catch, and Window Trim Screws.

1940 KIT

BUTTON / FLAT SOCKET/ SOCKET HEAD - CUSTOM LOOK	# 9-1800	\$ 425.00
INDENTED HEX/ HEX/ PHILLIPS HEAD - ORIGINAL STYLE	9-1801	460.00

1941-48 KIT

BUTTON / FLAT SOCKET / SOCKET HEAD - CUSTOM LOOK	6-8350	370.50
INDENTED HEX / HEX / PHILLIPS HEAD - ORIGINAL STYLE	6-8351	405.00

1949-50 KIT

BUTTON / FLAT SOCKET / SOCKET HEAD - CUSTOM LOOK	6-8498	385.00
INDENTED HEX / HEX / PHILLIPS HEAD - ORIGINAL STYLE	6-8499	405.00

1951-52 KIT

BUTTON / FLAT SOCKET / SOCKET HEAD - CUSTOM LOOK	6-8448	365.00
INDENTED HEX / HEX / PHILLIPS HEAD - ORIGINAL STYLE	6-8449	395.00

1953-1954 KIT - 891 PC

BUTTON / FLAT SOCKET HEAD / SOCKET HEAD - CUSTOM LOOK	6-8450	365.75
INDENTED HEX / HEX / PHILLIPS HEAD - ORIGINAL STYLE	6-8451	385.00



ACCESSORY KITS (NOT INCLUDED IN THE BODY KIT)

ENGINE KITS - SEE PAGE 19-23

GRILL ASSEMBLY - 1940

BUTTON HEAD & NYLONS	# 9-1810	\$ 11.00
TRUSS HEAD & KEP NUTS	9-1811	10.00

HOOD HINGE SHOULDER BOLTS -

SET OF (4) MADE IN OUR SHOP FROM 17-4 PH HIGH STRENGTH STAINLESS WITH WAVE WASHERS

1940:

BUTTON HEAD	9-1824	80.00
HEX HEAD (ORIGINAL STYLE)	9-1825	81.75

1941-54:

BUTTON HEAD	6-8398	82.00
HEX HEAD (ORIGINAL STYLE)	6-8399	83.50

**WE WERE INTO CARS EARLY
- NOW IF WE LOWER IT A
LITTLE, AND DROP IN A CADDY
V8, DO YOU THINK DAD WILL
NOTICE?**



BODY & SUSPENSION KITS FOR 1955-57 CHEVROLET



Body Kits include component kits for Bumpers & Brackets, Door Hinges, Door Latches & Strikers, Door Sills, Filler Tube, Firewall, Front Sheet Metal, Gas Tank Mount, Glove Box, Headlight Mounting Screws, Hood Hinges, Hood Latch & Catch, 1957 Hood Assembly, Misc. Interior Trim Screws, Lens Screws, Radiator Support, Seat trim, Steering Box Cover & Column, Trunk Hinges, Trunk Latch & Catch, and Window Trim Screws.

** NOTE: INDENTED HEX (ORIGINAL STYLE) BOLTS ARE MADE IN USA **

1955 CONVERTIBLE KIT - 893 PIECES

BUTTON HEAD	# 6-1150	\$ 420.50
HEX HEAD	6-1076	410.75
INDENTED HEX	6-7911	440.00
ORIGINAL STYLE - INDENTED HEX WITH BLACK STAINLESS (WHERE APPROPRIATE)	6-1077	450.00

1955 HARDTOP KIT - 848 PIECES

BUTTON HEAD	6-1066	380.75
HEX HEAD	6-1067	365.75
INDENTED HEX	6-7910	395.00
ORIGINAL STYLE - INDENTED HEX WITH BLACK STAINLESS (WHERE APPROPRIATE)	6-1068	405.00

1955 NOMAD KIT - 1024 PIECES

BUTTON HEAD	6-7930	410.75
HEX HEAD	6-7931	399.00
INDENTED HEX	6-7932	430.25
ORIGINAL STYLE - INDENTED HEX WITH BLACK STAINLESS (WHERE APPROPRIATE)	6-7933	450.50

1955 SEDAN KIT- 843 PIECES

BUTTON HEAD	6-1063	385.75
HEX HEAD	6-1064	375.00
INDENTED HEX	6-7909	390.50
ORIGINAL STYLE - INDENTED HEX WITH BLACK STAINLESS (WHERE APPROPRIATE)	6-1065	405.00
SIX POINT -POLISHED	6-9611	955.00

1956 CONVERTIBLE KIT - 889 PIECES

BUTTON HEAD	6-1084	435.75
HEX HEAD	6-1085	425.50
INDENTED HEX	6-7914	445.50
ORIGINAL STYLE - INDENTED HEX WITH BLACK STAINLESS (WHERE APPROPRIATE)	6-1086	460.50

1956 HARDTOP KIT - 844 PIECES

BUTTON HEAD	6-1081	360.50
HEX HEAD	6-1082	355.00
INDENTED HEX	6-7913	385.00
ORIGINAL STYLE - INDENTED HEX WITH BLACK STAINLESS (WHERE APPROPRIATE)	6-1083	415.00

1956 NOMAD KIT - 990 PIECES

BUTTON HEAD	6-7934	410.00
HEX HEAD	6-7935	399.00
INDENTED HEX	6-7936	435.00
ORIGINAL STYLE - INDENTED HEX WITH BLACK STAINLESS (WHERE APPROPRIATE)	6-7937	570.00

1956 SEDAN KIT - 840 PIECES

BUTTON HEAD	6-1078	375.50
HEX HEAD	6-1079	350.00
INDENTED HEX	6-7912	490.00
ORIGINAL STYLE - INDENTED HEX WITH BLACK STAINLESS (WHERE APPROPRIATE)	6-1080	530.50

1957 CONVERTIBLE KIT- 971 PIECES

BUTTON HEAD	6-1093	475.00
HEX HEAD	6-1094	470.75
INDENTED HEX	6-7916	420.00
ORIGINAL STYLE - INDENTED HEX WITH BLACK STAINLESS (WHERE APPROPRIATE)	6-1095	525.50



Body kit shown for a 1955 hardtop

1957 HARDTOP KIT - 927 PIECES

BUTTON HEAD	# 6-1090	\$ 455.75
HEX HEAD	6-1091	445.50
INDENTED HEX	6-1054	455.75
ORIGINAL STYLE - INDENTED HEX WITH BLACK STAINLESS (WHERE APPROPRIATE)	6-1092	490.50

1957 NOMAD KIT - 1090 PIECES

BUTTON HEAD	6-7938	470.75
HEX HEAD	6-7939	455.75
INDENTED HEX	6-7940	505.00
ORIGINAL STYLE - INDENTED HEX WITH BLACK STAINLESS (WHERE APPROPRIATE)	6-7941	530.00

1957 SEDAN KIT - 900 PIECES

BUTTON HEAD	6-1087	455.75
HEX HEAD	6-1088	445.00
INDENTED HEX	6-7915	470.75
ORIGINAL STYLE - INDENTED HEX WITH BLACK STAINLESS (WHERE APPROPRIATE)	6-1089	480.75



Uncle Sam's '57 four door hardtop in 1967.

-SEE NEXT PAGE FOR ACCESSORY KITS-

ACCESSORY KITS FOR 1955-57 CHEVY'S (NOT INCLUDED IN THE BODY KIT)

CHASSIS KIT FOR 55-57 - INCLUDES FRONT & REAR SUSPENSION KITS, PLUS STEERING BOX KIT

SIX POINT - HIGH STRENGTH	# 6-7928	\$ 639.25
TWELVE POINT - HIGH STRENGTH	6-7950	642.75

BODY MOUNT - WITH HEAVY DUTY WASHERS:

- HIGH STRENGTH - SIX POINT

SEDAN & WAGON	6-7925	133.75
HARDTOP	6-7926	175.50
CONVERTIBLE	6-7929	220.25

- HIGH STRENGTH - TWELVE POINT

SEDAN & WAGON	6-7954	140.00
HARDTOP	6-7955	182.25
CONVERTIBLE	6-7956	227.00

BUMPERETTES KIT FOR '55's:

CARRIAGE HEAD	6-7957	31.00
---------------	--------	-------

CONVERTIBLE TOP KIT - FITS 55-57 - 178PC

FOR ASSEMBLING & INSTALLING YOUR TOP		
BUTTON/FLAT SOCKET HEAD	6-7947	342.00
ORIGINAL STYLE	6-7948	361.00

GUIDE PINS FOR TOPS:

ORIGINAL STYLE - POLISHED:

2-8100 \$21.00 EACH



FRONT SUSPENSION BOLT KITS -158 PCS

IN HIGH STRENGTH BOLTS! INCLUDES GREASE ZERKS & COTTER PINS *CASTLE NUTS NOT INCLUDED SEE PAGE 130

SIX POINT - HIGH STRENGTH	6-1098	383.00
TWELVE POINT - HIGH STRENGTH	6-1099	385.00

REAR SUSPENSION BOLT KITS

-GRADE 8 STAINLESS! INCLUDES U-BOLTS AND TALL NUTS PLUS THE THROUGH BOLTS FOR THE SPRINGS AND HARDWARE FOR THE SHOCKS!

SIX POINT - HIGH STRENGTH	6-7922	241.00
TWELVE POINT - HIGH STRENGTH	6-7949	242.00

STEERING BOX KIT - WITH HEAVY HEX NUTS

CARRIAGE HEAD - HIGH STRENGTH 17-4PH	6-1051	82.20
--------------------------------------	--------	-------

ORIGINAL STYLE ENGINE KITS

-SEE THE STRAIGHT SIX CHEVY ENGINE KITS - PAGE 19

-SEE THE SMALL BLOCK CHEVY ENGINE KITS - PAGE 21

HIDDEN DOOR HINGE BOLTS

HEX HEAD	6-1050	10.50
----------	--------	-------

REAR DOOR KITS - 4 DOOR CARS

PHILLIPS HEAD	6-7942	41.50
FLAT SOCKET	6-7943	42.00

SEDAN DELIVERY LIFTGATE BOLT KIT

BUTTON/FLAT SOCKET	6-1001	16.75
ORIGINAL STYLE	6-1006	17.75

KITS FOR 1958 FULL SIZE CHEVYS

BODY & SUSPENSION KITS FOR 1958-1968 FULL SIZE CHEVYS (BELAIR, BISCAYNE, IMPALA)

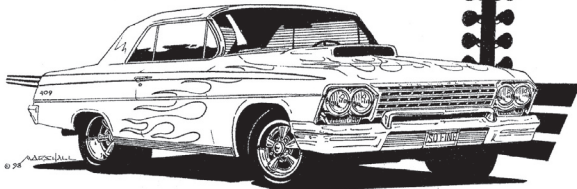

BODY KIT- Includes 720 Pieces in component kits for Bumpers, Door Hinges, Door Jambs, Door Latches & Strikers, Firewall & Cowl, Front & Inner Fenders, Gas Filler Door, Grill & Gravel Pan, Hood Latch & Catch & Trim, Hood Hinges, Headlights & Turn Signals, Interior (139 Pieces!), Radiator/Core Support, Horns, & Front Body Mount, Seat Mount, Splash Pans Under Radiator, Tail Lights & Trunk Hinges, Latch & Catch.

** NOTE INDENTED HEX, & ORIGINAL STYLE BOLTS ARE MADE IN USA **

PICK YOU BOLT STYLE!

BUTTON & SOCKET HEAD
INDENTED HEX HEAD
ORIGINAL STYLE-INDENTED HEX
WITH BLACK STAINLESS (WHERE APPROPRIATE)

Part

6-8800
6-8802
6-8803

Price:

\$ 375.00
405.00
420.00

ACCESSORY KITS (NOT INCLUDED IN THE BODY KIT)

BODY MOUNT KITS - SUPPLEMENTAL

TO THE FRONT BODY MOUNT KIT (12 BOLTS & WASHERS)

SIX POINT HEAD - HIGH STRENGTH	# 6-8868	\$120.75
12 POINT HEAD - HIGH STRENGTH	6-8869	124.75

CONVERTIBLE INTERIOR DOOR & QUARTER PANELS KIT

PHILLIPS OVAL	6-8851	12.00
---------------	--------	-------

CONVERTIBLE TOP CATCHES & LATCHES

POLISHED OVAL HEAD	6-8850	12.00
--------------------	--------	-------

ENGINE KITS - SEE PAGES 19-23

REAR DOORS KIT - FOR 4 DOOR CARS

BUTTON/FLAT SOCKET	6-8855	62.00
ORIGINAL STYLE	6-8856	46.75

CHASSIS KIT - INCLUDES FRONT & REAR

SUSPENSION PLUS STEERING BOX

SIX POINT - HIGH STRENGTH	# 6-8872	\$ 661.50
---------------------------	----------	-----------

FRONT SUSPENSION KITS (117 PIECES!)

-COMPLETE WITH GREASE FITTING & COTTER PINS

CASTLE NUTS NOT INCLUDED - SEE PAGE 130

SIX POINT - HIGH STRENGTH	6-8870	404.75
---------------------------	--------	--------

REAR SUSPENSION KIT

DOES NOT INCLUDE THE SHOULDERED "L" BOLTS

SIX POINT - HIGH STRENGTH	6-8871	189.00
---------------------------	--------	--------

STEERING BOX KIT

SIX POINT - HIGH STRENGTH	6-8950	66.00
---------------------------	--------	-------

TRANSMISSION & REAR COVER KITS

-SEE PAGES 29-31

KITS FOR 1959-1960 FULL SIZE CHEVYS

BODY KIT- Every Body Kit includes component kits for Bumpers, Cowl Cover, Door Hinges, Door Jambs, Filler Panel (Stone Guard), Front Body Mount, Front & Inner Fenders, Hood Latch & Catch, Hood Hinges, Headlights & Turn Signals, Interior, License Plate & Light, Radiator/Core Support, Battery Box, & Front Body Mount, Seat Mount, Tail Lights & Trunk Hinges, Latch & Catch (Tail gate, etc in El Camino kit).

Contains one of each component kit for:	FULL SIZE CARS - 783 pc		EL CAMINO - 930 pc	
BUTTON & SOCKET HEAD	# 6-8900	\$ 475.00	# 6-8990	\$ 550.00
INDENTED HEX HEAD	6-8902	505.00	6-8991	575.00
ORIGINAL STYLE-INDENTED HEX WITH BLACK STAINLESS (WHERE APPROPRIATE)	6-8903	530.50	6-8992	590.00

** NOTE INDENTED HEX, & ORIGINAL STYLE BOLTS ARE MADE IN USA **

ACCESSORY KITS (NOT INCLUDED IN THE BODY KIT)

CHASSIS KIT - INCLUDES FRONT & REAR SUSPENSION PLUS STEERING BOX
SIX POINT - HIGH STRENGTH # 6-8959 \$ 821.00

FRONT SUSPENSION KIT

-COMPLETE WITH GREASE FITTINGS & COTTER PINS
CASTLE NUTS NOT INCLUDED - SEE PAGE 130
SIX POINT - HIGH STRENGTH 6-8951 462.75

REAR SUSPENSION KIT

-DOES NOT INCLUDE SHOULDERED "L" BOLTS
SIX POINT - HIGH STRENGTH 6-8952 291.50

TRANSMISSION KITS - SEE PAGE 29

STEERING BOX KIT

SIX POINT - HIGH STRENGTH # 6-8950 \$ 66.00

BODY MOUNT KITS - SUPPLEMENTAL

TO THE FRONT BODY MOUNT KIT (10 BOLTS & WASHERS)
HEX HEAD 6-8946 63.25
SOCKET HEAD 6-8947 83.25
SIX POINT HEAD - HIGH STRENGTH 6-8970 143.50
12 POINT HEAD - HIGH STRENGTH 6-8971 147.25

CONVERTIBLE TOP TRIM KIT - 40 pc

ORIGINAL STYLE - SCREWS & SNAPS 6-8948 20.00

ENGINE KITS - SEE PAGES 17-21

KITS FOR 1961-1964 FULL SIZE CHEVYS

BODY KIT- Every Body Kit includes component kits for Bumpers, Door Hinges, Door Jambs, Filler Panel (Stone Guard), Firewall, Front & Inner Fenders, Gas Tank, Hood Latch & Hinges, Headlights & Turn Signals, Interior, Radiator/Core Support/Front Body Mount, Battery Box, Tail Lights & Trunk Hinges, Latch & Catch.

Contains one of each component kit - 731 PIECES!	1961		1962		1963-1964	
BUTTON & SOCKET HEAD	# 6-8200	\$ 525.00	# 6-8247	\$ 460.50	# 6-8250	\$ 510.50
INDENTED HEX HEAD	6-8202	540.00	6-8248	530.25	6-8252	535.75
WITH BLACK STAINLESS (WHERE APPROPRIATE)	6-8230	580.25	6-8249	540.75	6-8253	580.75
SIX POINT (SMALL HEX FLANGE HEAD) - POLISHED	6-8246	1397.25	6-8273	1244.75	6-8274	1403.50

** NOTE INDENTED HEX, ORIGINAL STYLE, & SIX POINT BOLTS ARE MADE IN USA **

ACCESSORY KITS (NOT INCLUDED IN THE BODY KIT)

CHASSIS KIT - INCLUDES ALL KITS WITH AN * BESIDE THE TITLE # 6-8961 \$ 924.75

BRAKE & FUEL LINES KITS *

BUTTON HEAD 6-8276 7.00
INDENTED HEX 6-8277 9.75

ENGINE MOUNTS TO FRAME KITS*

SIX POINT - HIGH STRENGTH 6-8949 64.00
TWELVE POINT - HIGH STRENGTH 6-8953 65.75

FRONT SUSPENSION KIT * - 110 PIECES!

-COMPLETE WITH GREASE FITTINGS & COTTER PINS
CASTLE NUTS NOT INCLUDED - SEE PAGE 130
SIX POINT - HIGH STRENGTH 6-8951 462.75

STEERING BOX KIT*

SIX POINT - HIGH STRENGTH 6-8950 66.00

REAR SUSPENSION *

-DOES NOT INCLUDE SHOULDERED "L" BOLTS
SIX POINT - HIGH STRENGTH 6-8952 291.50

TRANSMISSION CROSSMEMBER KITS*

SIX POINT - HIGH STRENGTH 6-8974 31.50
TWELVE POINT - HIGH STRENGTH 6-8975 32.75

BODY MOUNT KITS - SUPPLEMENTAL

TO THE FRONT BODY MOUNT KIT (12 BOLTS & WASHERS)
HEX HEAD 6-8272 68.00
SOCKET HEAD 6-8275 99.75
SIX POINT HEAD - HIGH STRENGTH 6-8289 167.25
12 POINT HEAD - HIGH STRENGTH 6-8290 169.00

ENGINE KITS - SEE PAGES 19-23

TRANSMISSION KITS - SEE PAGE 29



BIG BROTHER'S AIR BAGGED IMPALA, POWERED BY A 350TPI WITH A 700-R4



KITS FOR 1965-1968 FULL SIZE CHEVYS

BODY KIT- Every Body Kit includes component kits for Bumpers, Door Hinges, Door Jambs, Firewall & Cowl, Front Body Mount, Front & Inner Fenders, Gas Tank, Hood Latch & Hinges, Grill, Headlights & Turn Signals, Interior (130 Pieces!), Radiator/Core Support, Battery Box, Rear Window Trim, Seat Mount, Tail Lights & Trunk Hinges, Latch & Catch & Trunk Lid Trim/Light/Catch.

Contains one of each component kit

	1965-1966		1967-1968	
	CONVERTIBLE	SEDAN / H-TOP	SEDAN / H-TOP	
	791 PIECES	676 PIECES	756 PIECES	
BUTTON AND SOCKET HEAD	# 6-8343 \$ 410.00	# 6-8300 \$ 399.00	# 6-8400 \$ 405.00	
INDENTED HEX HEAD	6-8344 440.75	6-8301 415.75	6-8402 440.25	
ORIGINAL STYLE-INDENTED HEX	6-8345 490.00	6-8302 460.50	6-8403 505.25	

WITH BLACK STAINLESS (WHERE APPROPRIATE)

** NOTE INDENTED HEX, & ORIGINAL STYLE BOLTS ARE MADE IN USA **

ACCESSORY KITS (NOT INCLUDED IN THE BODY KIT)

CHASSIS KIT - 1965-67: INCLUDES FRONT & REAR SUSPENSION, STEERING BOX, TRANSMISSION CROSS-MEMBER, & ENGINE MOUNT TO FRAME KITS
SIX POINT - HIGH STRENGTH # 6-8340 \$ 818.50

ENGINE MOUNTS TO FRAME KITS

SIX POINT - HIGH STRENGTH 6-1945 40.50
TWELVE POINT - HIGH STRENGTH 6-1946 44.25

FRONT SUSPENSION KITS

-1965-1967 (104 PIECES!): COMPLETE WITH GREASE FITTINGS & COTTER PINS. -DOES NOT INCLUDE THE (2) CAM BOLTS, *CASTLE NUTS NOT INCLUDED - SEE PAGE 130*
SIX POINT - HIGH STRENGTH 6-8338 317.50

REAR SUSPENSION KIT

-1965-67 (44 PIECES)
-CONTAINS BOLTS FOR DUAL UPPER CONTROL ARMS
SIX POINT - HIGH STRENGTH 6-8336 370.00

STEERING BOX KITS

1965-1967
SIX POINT - HIGH STRENGTH # 6-8334 \$ 55.50

TRANSMISSION CROSSMEMBER KIT

SIX POINT - HIGH STRENGTH 6-1768 35.25
TWELVE POINT - HIGH STRENGTH 6-1771 37.50

BODY MOUNT KITS - SUPPLEMENTAL

TO THE FRONT BODY MOUNT KIT (8 BOLTS & 8 WASHERS)

** BUY (2) KITS FOR CONVERTIBLES - THEY NEED 16! **

HEX HEAD 6-8980 44.75
SOCKET HEAD 6-8981 63.25
SIX POINT HEAD - HIGH STRENGTH 6-8982 105.75
12 POINT HEAD - HIGH STRENGTH 6-8983 108.00

DOOR STRIKER BOLTS & WASHERS - 1 PAIR

SOCKET HEAD 6-8154 59.95

ENGINE KITS - SEE PAGES 19-23

KITS FOR 1991-1996 CAPRICE/IMPALA

BODY KIT- Every Body Kit includes component kits for Bumpers, Door Hinges, Door Jambs, Firewall & Cowl, Front Body Mount, Front & Inner Fenders, Gas Tank, Hood Latch & Hinges, Grill, Headlights & Turn Signals, Interior (130 Pieces!), Radiator/Core Support, Battery Box, Trunk Seal, Seat Mount, Tail Lights & Trunk Hinges, Latch & Catch & Trunk Lid Trim/Light/Catch.

Contains one of each component kit

BUTTON HEAD	# 5-2001	\$245.00
HEX HEAD	5-2002	235.50

ACCESSORY KITS (NOT INCLUDED IN THE BODY KIT)

CHASSIS KIT - INCLUDES ALL KITS WITH AN * BESIDE THE TITLE - HIGH STRENGTH

1994-95 WITH STOCK TRAILING ARMS: # 5-2094 \$ 836.00
1996 WITH BOXED TRAILING ARMS: 5-2099 862.75

ENGINE MOUNTS TO FRAME KIT*

SIX POINT - HIGH STRENGTH 5-2093 71.25

SUSPENSION KITS* - FOR USE WITH STOCK BUSHINGS COMPLETE WITH GREASE FITTINGS & COTTER PINS, **CASTLE NUTS NOT INCLUDED - SEE PAGE 130**

-DOES NOT INCLUDE SWAY BAR KIT FOR REAR - (NEED TO KNOW IF CONTROL ARMS ARE BOXED)
FRONT: SIX POINT - HIGH STRENGTH 5-2090 373.25
REAR: SIX POINT - HIGH STRENGTH 5-2097 247.00

STEERING BOX KIT *

SIX POINT - HIGH STRENGTH # 5-2091 \$ 44.75

SWAY BAR KITS* - HIGH STRENGTH

- FOR 1994 & 1995 CARS WITH STOCK TRAILING ARMS:
5-0000 49.25
- FOR 1996 CARS & ALL YEARS WITH BOXED TRAILING ARMS
5-2000 78.25

TRANSMISSION CROSSMEMBER KIT *

SIX POINT - HIGH STRENGTH 5-2095 48.75

ENGINE KITS - SEE PAGES 21-22

TRANSMISSION & REAR COVER KITS

- SEE PAGES 29,30, & 31



TOLL FREE ORDER LINE : 1-800-767-4781

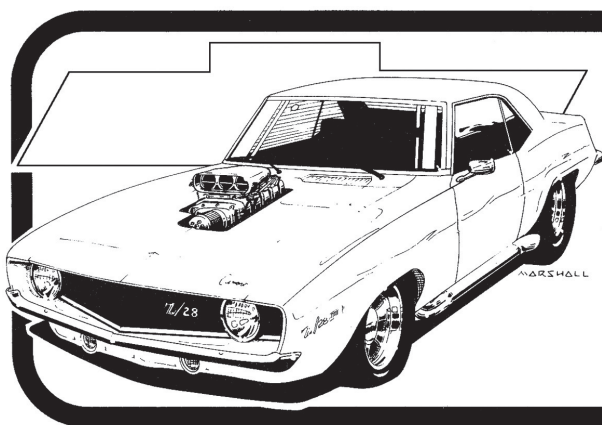

BODY AND SUSPENSION KITS FOR CAMAROS & FIREBIRDS

BODY KITS FOR 1967-1969 CAMARO & FIREBIRD

BODY KIT- Every Body Kit includes component kits for Front Body Mount, Bumpers, Door Hinges, Door Jambs, Firewall, Front Sheet Metal, Gas Tank Mounting, Grill, Headlight Mounts, Hood Hinges, Interior, Rear Axle Stop, Seat Mount & Trunk Hinges, Latch & Catch. Over 450 Pieces and available in 5 different bolt styles!

BODY KITS FOR 1967-69 CAMARO:

(Contains one of each component kit)

BUTTON & SOCKET HEAD (CUSTOM STYLE)
INDENTED HEX HEAD
ORIGINAL STYLE-INDENTED HEX
WITH BLACK STAINLESS (WHERE APPROPRIATE)
SIX POINT - POLISHED - HIGH STRENGTH
TWELVE POINT - POLISHED - HIGH STRENGTH

COUPE KITS		CONVERTIBLE KITS	
Part #	Price:	Part #	Price:
# 6-1639	\$ 265.00	# 6-1592	\$275.75
6-1691	325.00	6-1593	365.00
6-1692	370.75	6-1594	390.00
6-1600	798.75	6-1595	805.50
6-1685	836.75	6-1589	844.50

BODY KITS FOR 1967-1969 FIREBIRD - OVER 520 PIECES!

BUTTON HEAD (CUSTOM STYLE)
INDENTED HEX HEAD
ORIGINAL STYLE-INDENTED HEX
WITH BLACK STAINLESS (WHERE APPROPRIATE)
SIX POINT - POLISHED - HIGH STRENGTH
TWELVE POINT - POLISHED - HIGH STRENGTH

6-2800	285.00	6-2798	299.00
6-2801	385.25	6-2799	405.25
6-2802	420.25	6-2817	430.00
6-2803	874.50	6-2880	885.50
6-2804	916.00	6-2829	930.25

** NOTE SIX & TWELVE POINT, INDENTED HEX, & ORIGINAL STYLE BOLTS ARE MADE IN USA **

ACCESSORY KITS (NOT INCLUDED IN THE BODY KIT)

CHASSIS KIT - INCLUDES ALL KITS WITH AN *
BESIDE THE TITLE

SIX POINT - HIGH STRENGTH	# 6-1680	\$ 888.75
TWELVE POINT - HIGH STRENGTH	6-1684	902.75

(SUB FRAME MOUNT KIT IS 6 POINT)

** SEE PAGES 32 & 33 FOR AFTERMARKET KITS **

FRONT SUSPENSION KIT* - 86 PIECES!

-HIGH STRENGTH STAINLESS PLUS GREASE FITTINGS &
COTTER PINS, *CASTLE NUTS NOT INCLUDED - SEE PG 130*

SIX POINT - HIGH STRENGTH	6-1681	362.25
TWELVE POINT	6-1676	364.75

REAR SUSPENSION KIT* - INCLUDES 1/2" U-BOLTS

SIX POINT - HIGH STRENGTH	6-1687	284.00
TWELVE POINT - HIGH STRENGTH	6-1683	289.75

STEERING BOX COVER & MOUNT*

SIX POINT - HIGH STRENGTH	6-1607	60.00
TWELVE POINT - HIGH STRENGTH	6-1613	62.50

SUB-FRAME TO BODY MOUNT KIT*

- FOR STANDARD BODY BUSHINGS - IN CHASSIS KIT

SIX POINT - HIGH STRENGTH	6-1699	148.50
---------------------------	--------	--------

- FOR SOLID BODY BUSHINGS (3 1/2" BOLTS)

SIX POINT - HIGH STRENGTH	6-1645	149.25
---------------------------	--------	--------

TRANSMISSION CROSSMEMBER KITS*

SIX POINT - HIGH STRENGTH	6-1768	35.25
TWELVE POINT - HIGH STRENGTH	6-1771	37.50

ENGINE KITS - SEE PAGES 19-23

CONVERTIBLE TOP ASSEMBLY KITS: 208PC
ASSEMBLY LIST & ILLUSTRATION ARE INCLUDED

BUTTON & FLAT SOCKET HEAD	6-2828	459.50
HEX & PHILLIPS HEAD - ORIGINAL STYLE	6-2827	463.00



HEADER BAR ADJUSTMENT SCREWS ARE JUST (2) OF THE 208 PC
IN OUR CONVERTIBLE TOP ASSEMBLY KIT FOR 67-69 CAMAROS. THESE
ARE AVAILABLE SEPERATELY: 2-8289 \$33.50 EA.

DOOR STRIKERS KIT - SOCKET HEAD SHOULDER
BOLTS WITH WASHERS 6-8154 59.95

HIDE-AWAY HEAD LIGHTS KIT FOR 67-68 RS
ORIGINAL STYLE 6-1635 29.25

REAR SEAT RIVET REPLACEMENTS

- SOCKET HEAD SHOULDER BOLTS 2-8187 22.50 EA.

TRANSMISSION & REAR COVER KITS

-SEE PAGES 29,30, & 31

KITS FOR 1970-1981 CAMARO/FIREBIRD

(BODY KITS WORK WELL FOR MOST OF THE PARTS ON FIREBIRDS TOO)

BODY KIT- Every Body Kit includes component kits for Front Body Mount, Brake & Fuel Line, Bumpers, Bumper Mounting, Door Hinges, Door Jambs, Headlight & Front Turn Signals, Heater & Air Conditioner Cover, Front/Inner Fenders and Windshield & Recovery Tank, Hood Hinges, Hood Latch & Catch, Interior (70-77), Radiator Support & Battery Box, Rear Axle Stop, Rear Bumper Mount (74-81), Trunk Hinges, Latch, and Windshield Wipers and Cowl Vents.

KITS FOR CAMAROS: 1970-1973

BUTTON HEAD	# 6-8000	\$ 265.75
HEX HEAD	6-8001	299.50
INDENTED HEX	6-8002	355.00
ORIGINAL STYLE	6-8003	385.00
-INDENTED HEX WITH BLACK STAINLESS (WHERE APPROPRIATE)		
SIX POINT - POLISHED	6-8087	831.50
12 POINT - POLISHED	6-7851	870.50

1974-1977

# 6-8005	\$ 285.00
6-8006	310.00
6-8007	360.50
6-8008	390.00
6-8097	885.50
6-7852	923.50

1978-1981

# 6-8010	\$ 250.00
6-8011	275.00
6-8012	325.25
6-8013	345.25
6-7850	860.00
6-7853	898.75

** NOTE INDENTED HEX, ORIGINAL STYLE, SIX, & TWELVE POINT BOLTS ARE MADE IN USA **

ACCESSORY KITS (NOT INCLUDED IN THE BODY KIT)

CHASSIS MASTER KITS - INCLUDES FRONT & REAR SUSPENSION, STEERING BOX, SUB FRAME TO BODY & TRANSMISSION CROSSMEMBER KITS - HIGH STRENGTH - FOR:

1970-76 CAMARO:	SIX POINT	# 6-8043	\$ 836.00
	TWELVE POINT	6-2847	883.25
1970-72 FIREBIRD:	SIX POINT	6-8094	854.00
	TWELVE POINT	6-2848	907.00
1977-81 CAMARO & 1973-81 FIREBIRD	SIX POINT	6-8053	957.00
	TWELVE POINT	6-2849	1019.50

FRONT SUB-FRAME TO BODY MOUNT KIT

SIX POINT - HIGH STRENGTH	6-8084	148.50
---------------------------	--------	--------

FRONT SUSPENSION KIT - HIGH STRENGTH

CASTLE NUTS NOT INCLUDED - SEE PAGE 130 KITS FOR:

1970-76 CAMARO:	SIX POINT	6-8048	312.00
	TWELVE POINT	6-8038	355.75
1970-72 FIREBIRD:	SIX POINT	6-8086	330.00
	TWELVE POINT	6-2845	379.75
1977-81 CAMARO & 1973-81 FIREBIRD	SIX POINT	6-8058	417.50
	TWELVE POINT	6-2846	465.50

REAR SUSPENSION KIT - INCLUDES (4) 1/2" U-BOLTS (U-BOLTS ARE USED IN PLACE OF STOCK T-BOLTS)

1970-76:	SIX POINT	# 6-1687	\$ 284.00
	TWELVE POINT	6-2843	286.00
1977-81:	SIX POINT	6-1688	299.75
	TWELVE POINT	6-2844	302.25

STEERING BOX COVER & MOUNT KIT

SIX POINT - HIGH STRENGTH	6-8071	58.50
TWELVE POINT - HIGH STRENGTH	6-8075	67.00

TRANSMISSION CROSSMEMBER KITS

SIX POINT - HIGH STRENGTH	6-1768	35.25
TWELVE POINT - HIGH STRENGTH	6-1771	37.50

TRANSMISSION & REAR COVER KIT

- SEE PAGES 29 & 30

DOOR STRIKER BOLTS & WASHERS (PAIR)

SOCKET HEAD	6-8149	65.00
-------------	--------	-------

ENGINE KITS - SEE PAGES 17-24

KITS FOR 1982-1992 CAMARO/FIREBIRD

DOOR JAMB KIT - DOES BOTH DOORS

PHILLIPS HEAD	# 5-0909	\$ 6.25
---------------	----------	---------

DOOR STRIKER BOLTS & WASHERS

SOCKET HEAD (PAIR)	6-8149	65.00
--------------------	--------	-------

HEADLIGHT RETAINING SCREW KIT

ORIGINAL STYLE	5-0911	4.00
----------------	--------	------

LICENSE PLATE

ORIGINAL STYLE	5-0910	4.00
----------------	--------	------

TRANSMISSION KITS - SEE PAGE 29-31

ENGINE KITS - SEE PAGES 19-24

FENDERS, CORE SUPPORT, HOOD KITS

BUTTON HEAD	# 5-0900	\$ 25.00
HEX HEAD	5-0901	25.00
SIX POINT	5-0902	170.00

REAR COVER KITS - SEE PAGE 33

STEERING BOX COVER & MASTER CYLINDER

SIX POINT - HIGH STRENGTH	5-0903	23.50
TWELVE POINT - HIGH STRENGTH	5-0904	25.00



BODY & SUSPENSION KITS FOR CHEVELLE, MALIBU, & EL CAMINO

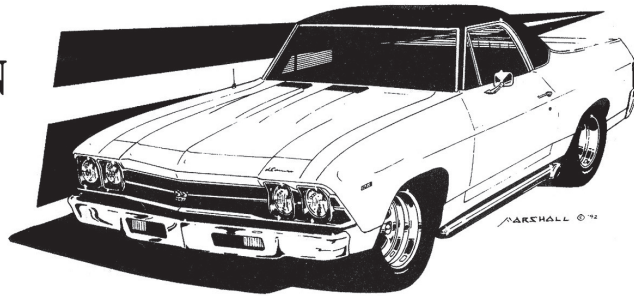

BODY KIT- Every Body Kit includes component kits for Bed Floor & Corner Cover (El Camino), Front Body Mount, Bumpers, Door Hinges, Door Jambs, Firewall, Front/Inner Fenders (Splash Pan & Horn for 1966-67), Front Fenders, Radiator Support, Battery Box & Horn, Gas Tank Mounting, 1964-65 Grill, Filler Panels, & Hood Stops, Grill Headlights, & Turn Signals, Hood Hinges, Latch & Catch, Inner Fenders, Interior Trim Screw, Lens Screw, License Plate & Bracket, Seat Mount, Radiator Support, Battery Box, & Windshield Washer, Tailgate (El Camino), Trunk Hinges, Latch & Catch, and Windshield Bottom Trim Screw. 456 to 667 Pieces!

** NOTE INDENTED HEX (ORIGINAL STYLE), SIX & TWELVE POINT BOLTS ARE MADE IN USA **

BODY KITS FOR 1964-1972 CHEVELLE & EL CAMINO

1964-1965 CHEVELLE-543 PIECES

BUTTON/SOCKET HEAD	# 6-8100	\$ 300.00
HEX HEAD	6-8101	310.00
INDENTED HEX HEAD	6-8102	340.00
ORIGINAL STYLE - INDENTED HEX WITH BLACK STAINLESS (WHERE APPROPRIATE)	6-8103	360.75
SIX POINT - HIGH STRENGTH	6-8123	730.75
TWELVE POINT - HIGH STRENGTH	9-1200	767.75

1964-1965 EL CAMINO-623 PIECES

BUTTON/SOCKET HEAD	6-8104	340.75
HEX HEAD	6-8105	345.00
INDENTED HEX HEAD	6-8106	360.00
ORIGINAL STYLE - INDENTED HEX WITH BLACK STAINLESS (WHERE APPROPRIATE)	6-8107	420.00
SIX POINT - HIGH STRENGTH	6-8143	754.00
TWELVE POINT - HIGH STRENGTH	9-1220	790.25

1966-1967 CHEVELLE-456 PIECES

BUTTON/SOCKET HEAD	6-1927	290.75
HEX HEAD	6-1928	310.00
INDENTED HEX HEAD	6-1929	340.00
ORIGINAL STYLE INDENTED HEX WITH BLACK STAINLESS (WHERE APPROPRIATE)	6-1931	375.25
SIX POINT - HIGH STRENGTH	6-1905	764.25
TWELVE POINT - HIGH STRENGTH	9-1250	804.50

1966-1967 EL CAMINO-546 PIECES

BUTTON/SOCKET HEAD	6-1938	325.00
HEX HEAD	6-1939	340.50
INDENTED HEX HEAD	6-1940	375.75
ORIGINAL STYLE - INDENTED HEX WITH BLACK STAINLESS (WHERE APPROPRIATE)	6-1941	415.25
SIX POINT - HIGH STRENGTH	6-1904	816.50
TWELVE POINT - HIGH STRENGTH	9-1260	849.25

1968-1969 CHEVELLE-535 PIECES

BUTTON/SOCKET HEAD	# 6-1733	\$ 285.25
HEX HEAD	6-1734	290.75
INDENTED HEX HEAD	6-1736	340.75
ORIGINAL STYLE INDENTED HEX WITH BLACK STAINLESS (WHERE APPROPRIATE)	6-1737	375.00
SIX POINT - HIGH STRENGTH	6-1735	783.50
TWELVE POINT - HIGH STRENGTH	9-1300	828.50

1968-1969 EL CAMINO-625 PIECES

BUTTON/SOCKET HEAD	6-1741	325.00
HEX HEAD	6-1742	330.50
INDENTED HEX HEAD	6-1743	385.50
ORIGINAL STYLE - INDENTED HEX WITH BLACK STAINLESS (WHERE APPROPRIATE)	6-1744	415.00
SIX POINT - HIGH STRENGTH	6-1760	805.50
TWELVE POINT - HIGH STRENGTH	9-1310	837.00

1970-72 CHEVELLE-577 PIECES

BUTTON/SOCKET HEAD	6-1780	320.50
HEX HEAD	6-1781	330.00
INDENTED HEX HEAD	6-1783	380.50
ORIGINAL STYLE - INDENTED HEX WITH BLACK STAINLESS (WHERE APPROPRIATE)	6-1784	415.75
SIX POINT - HIGH STRENGTH	6-1785	811.25
TWELVE POINT - HIGH STRENGTH	9-1350	822.50

1970-1972 EL CAMINO-667 PIECES

BUTTON/SOCKET HEAD	6-1790	365.00
HEX HEAD	6-1791	370.75
INDENTED HEX HEAD	6-1792	420.50
ORIGINAL STYLE INDENTED HEX WITH BLACK STAINLESS (WHERE APPROPRIATE)	6-1793	455.75
SIX POINT - HIGH STRENGTH	6-1789	843.00
TWELVE POINT - HIGH STRENGTH	9-1360	853.00

* **SIX POINT & TWELVE POINT KITS CONTAIN POLISHED BOLTS** *

-SEE NEXT PAGE FOR ACCESSORY KITS-

ACCESSORY KITS (NOT INCLUDED IN THE BODY KIT)

CHASSIS MASTER KIT - INCLUDES FRONT & REAR SUSPENSION, STEERING BOX, ENGINE MOUNTS & TRANSMISSION CROSSMEMBER KITS

SIX POINT - HIGH STRENGTH	# 6-8161	\$ 648.75
TWELVE POINT - HIGH STRENGTH	6-8199	665.50

AC CONDENSER MOUNT KITS - 1968-72

BUTTON HEAD	# 6-1798	\$ 9.75
HEX HEAD	6-1799	10.00
INDENTED HEX HEAD	6-1772	13.75
ORIGINAL STYLE - WITH BLACK STAINLESS WHERE APPROPRIATE	6-1774	15.25
SIX POINT - HIGH STRENGTH	6-1930	22.25
TWELVE POINT - HIGH STRENGTH	6-1954	23.00

BUCKET SEAT TRIM KIT - 1964-65

PHILLIPS HEAD	6-8144	8.00
---------------	--------	------

BODY MOUNT KITS - SUPPLEMENT TO FRONT MOUNT: SEDANS & HARD TOPS: (8 BOLTS & WASHERS)

HEX HEAD	6-1948	43.75
SOCKET HEAD	6-1949	62.25
SIX POINT - HIGH STRENGTH	6-1955	98.75
TWELVE POINT - HIGH STRENGTH	6-1958	105.00
CONVERTIBLES, EL CAMINO & WAGONS: (12 BOLTS & WASHERS)		
HEX HEAD	6-1951	64.00
SOCKET HEAD	6-1952	92.00
SIX POINT - HIGH STRENGTH	6-1953	147.50
TWELVE POINT - HIGH STRENGTH	6-1959	155.00

CONVERTIBLE HEADER BAR

PHILLIPS OVAL JACKSON	6-1762	11.50
-----------------------	--------	-------

DOOR STRIKER BOLTS & WASHERS

- HIGH STRENGTH 17-4 PH STAINLESS FOR LONGER WEAR		
SOCKET HEAD (PAIR)	6-8154	59.95



REAR SWAY BAR KIT

SIX POINT - HIGH STRENGTH	6-8185	46.25
TWELVE POINT - HIGH STRENGTH	6-8186	48.00

ENGINE KITS - SEE PAGES 19-23

ENGINE MOUNT TO FRAME KITS*

SIX POINT - HIGH STRENGTH	# 6-1945	\$ 40.50
TWELVE POINT - HIGH STRENGTH	6-1946	44.25

REAR COVER KITS - SEE PAGE 31

STEERING BOX COVER & MOUNT KITS*

SIX POINT - HIGH STRENGTH	6-1936	57.50
TWELVE POINT - HIGH STRENGTH	6-1937	65.75

FRONT & REAR SUSPENSION KITS*

- HIGH STRENGTH STAINLESS BOLTS COMPLETE WITH SPECIAL WASHERS, SWAY BAR END LINKS WITH SPACERS, GREASE ZERKS & COTTERS

CASTLE NUTS NOT INCLUDED - SEE PAGE 130

SIX POINT - HIGH STRENGTH	6-8156	521.75
TWELVE POINT - HIGH STRENGTH	6-8198	513.00

TRANSMISSION CROSSMEMBER KITS*

SIX POINT - HIGH STRENGTH	6-1768	35.25
TWELVE POINT - HIGH STRENGTH	6-1771	37.50

TRANSMISSION KITS - SEE PAGE 31-32

WHEEL WELL MOULDING KIT

ORIGINAL STYLE - ROUND WASHER HEAD	6-1796	8.00
CUSTOM STYLE - BUTTON HEAD	6-1764	9.00

REAR SHOCK MOUNT STUD KIT - CUSTOM

MADE HIGH STRENGTH 17-4 PH STUDS WITH NUTS & WASHERS		
	6-8170	77.00



T · O · T · A · L · L · Y
STAINLESS



TOLL FREE ORDER LINE : 1-800-767-4781

KITS FOR 1978 - 1987 MALIBU & EL CAMINO

BUMPER KITS

-FRONT BUMPER

BUTTON HEAD	# 5-0821	\$ 19.00
HEX HEAD	5-0822	17.50

-REAR BUMPER

BUTTON HEAD	5-0835	16.50
HEX HEAD	5-0836	15.00

BATTERY BOX & HOLD DOWN KITS

BUTTON HEAD	5-0806	8.00
HEX HEAD	5-0807	7.75

DOOR HINGES KITS - DOES BOTH

HEX HEAD	5-0812	40.00
SOCKET HEAD	5-0813	40.00

DOOR LATCH KITS - DOES BOTH

FLAT SOCKET	5-0837	4.00
PHILLIPS HEAD	5-0838	4.00

DOOR STRIKER BOLTS & WASHERS

SOCKET HEAD (PAIR)	6-8149	65.00
--------------------	--------	-------

ENGINE KITS - SEE PAGES 19-23

FRONT BODY MOUNT KITS

HEX HEAD	5-0833	24.00
SOCKET HEAD	5-0834	24.25

FRONT & INNER FENDER KITS

BUTTON HEAD	5-0827	38.50
HEX HEAD	5-0828	36.00

FRONT SUSPENSION KITS

1978 THRU EARLY 1980 (US THREAD) - A BODY

SIX POINT - HIGH STRENGTH	6-8096	362.00
12 POINT - HIGH STRENGTH	6-8142	379.00

LATE 1980 & LATER (METRIC THREAD) - G BODY

SIX POINT - HIGH STRENGTH	5-0899	342.25
12 POINT - HIGH STRENGTH	5-0896	356.50

REAR SUSPENSION KITS

1978 THRU EARLY 1980 (US THREAD) - A BODY

SIX POINT - HIGH STRENGTH	6-8188	167.50
12 POINT - HIGH STRENGTH	6-8189	187.75

LATE 1980 & LATER (METRIC THREAD) - G BODY

SIX POINT - HIGH STRENGTH	5-0898	162.00
12 POINT - HIGH STRENGTH	5-0897	167.50

GAS TANK MOUNT KITS

HEX HEAD	# 5-0819	\$ 12.00
SOCKET HEAD	5-0820	13.00
TWELVE POINT - HIGH STRENGTH	5-0845	44.75

GRILL & PLASTIC EXTENSION KITS

BUTTON HEAD	5-0824	13.00
HEX HEAD	5-0825	13.00

HOOD HINGES KITS - DOES BOTH

BUTTON HEAD	5-0809	9.25
HEX HEAD	5-0810	8.00

MAIN BODY MOUNT KITS

HEX HEAD	5-0843	58.50
SOCKET HEAD	5-0844	59.00

HOOD LATCH & CATCH KITS

BUTTON HEAD	5-0803	8.50
HEX HEAD	5-0804	8.00

RADIATOR SUPPORT KITS

BUTTON HEAD	5-0800	10.50
HEX HEAD	5-0801	11.00

REAR COVER KITS - SEE PAGE 31

TRANSMISSION KITS - SEE PAGE 29-31

TRUNK HINGES & LATCH KITS

BUTTON HEAD	5-0814	9.00
HEX HEAD	5-0815	9.00

WASHER & OVERFLOW TANKS KITS

BUTTON HEAD	5-0830	6.00
HEX HEAD	5-0831	6.50
TWELVE POINT - HIGH STRENGTH	5-0846	19.50

STEERING BOX MOUNT & COVER KIT

SIX POINT - HIGH STRENGTH	6-8071	58.50
TWELVE POINT - HIGH STRENGTH	6-8075	67.00

STATION WAGON TAILGATE KITS

BUTTON HEAD	5-0538	21.00
HEX HEAD	5-0539	21.00

TAILGATE KITS FOR EL CAMINO

BUTTON HEAD	5-0817	15.00
HEX HEAD	5-0818	13.00

TAILGATE CABLE BOLTS (SET OF 4)

SOCKET HEAD	5-0840	107.00
-------------	--------	--------

KITS FOR 1965-1966 CORVAIR

BODY KITS - Every Body Kit includes component kits for Interior, Parking Brake, Seat Mount, Steering Column, Door Jamb, Door Hinges, Front Bumper, Front Brake Hose Bracket & Speedo Cable Bracket, Headlights & Horn, Fuel Tank Door & Tank Straps, Front Deck Lid, Windshield Washer Bottle, Wiper Linkage to Cowl, Front Ballast Cans, Rear Ballast Cans, Rear Cove Trim, Rear Roll Pan & License Plate, Rear Deck Vent Panel, Rear Bumper, Misc. Engine Compartment, and Spare Tire Bracket.

Contains one of each component kit

	SEDAN		CONVERTIBLE	
BUTTON HEAD	# 6-9500	\$ 275.00	# 6-9567	\$ 280.00
HEX HEAD	6-9501	285.00	6-9568	290.50
ORIGINAL STYLE - INDENTED HEX	6-9502	335.00	6-9569	345.75
WITH BLACK STAINLESS WHERE APPROPRIATE				

** NOTE ORIGINAL STYLE BOLTS ARE MADE IN USA **

ACCESSORY KITS (NOT INCLUDED IN THE BODY KIT)

ENGINE KIT - 190 pc. -1965/66:

BUTTON HEAD	# 6-9555	\$ 65.50
INDENTED HEX - ORIGINAL STYLE	6-9556	82.00

DOOR STRIKER BOLTS & WASHERS - 1 PAIR

WITH ORIGINAL STYLE WASHERS	
SOCKET HEAD	# 6-8148 \$ 85.75

**BODY &
CHASSIS KITS
FOR 1953-78
CORVETTES**

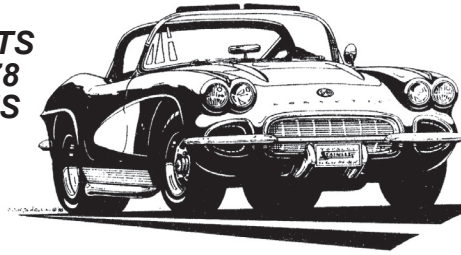

KITS FOR 1953-1962 CORVETTE

BODY KIT- Every Body Kit includes component kits for Battery Heat Shield, Door Hinges, Door Strikers, Firewall, Front Bumper & Mount, Front License Plate Brackets, Grill - with spacers (58-62), Hood Hinges & Brace, Hood Catch, Hood Latches & Stops, Horn, Interior Trim, Radiator/Core Support/Front Mount, Rear Bumpers, Seat Mount, Trunk & Deck Hinges, Latch & Catch, and Washer Tank Bracket & Horn Relay.

	1953-55:	1956-57:	1958-60:	1961-62:
BUTTON HEAD	# 9-6400 \$ 260.50	9-6450 310.75	6-4500 370.75	6-4526 370.75
ORIGINAL STYLE-INDENTED HEX HEAD	9-6401 325.50	9-6451 365.25	6-4524 430.25	6-4510 440.50

** NOTE ORIGINAL STYLE BOLTS ARE MADE IN USA **

ACCESSORY KITS (NOT INCLUDED IN THE BODY KIT)

57-62 CONVERTIBLE TOP KITS - 142 PIECES

- ALL SHOULDER BOLTS ARE HIGH STRENGTH 17-4 PH
STAINLESS - MADE IN OUR SHOP

BUTTON HEAD - CUSTOM (SHOWN BELOW)	# 6-4550 \$ 367.75
SLOTTED PAN HEAD - ORIGINAL STYLE	6-4551 391.00



1957-62 RIVET REPLACEMENT KIT

BUTTON HEAD (SHOWN BELOW)	6-4552 318.50
SHOULDERED RIVET KIT	6-4557 318.50

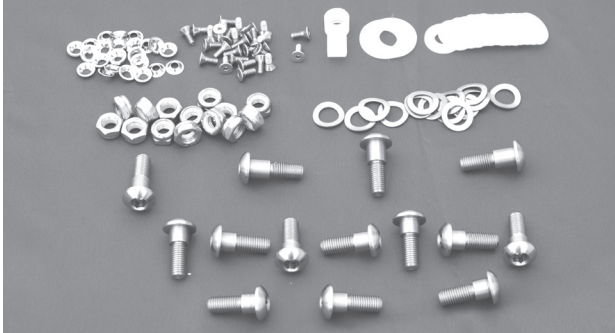

THE BUTTON HEAD RIVET REPLACEMENT KIT

INCLUDES SHOULDER BOLTS AND LOCK NUTS TO REPLACE THE RIVETS - THE SHOULDERED RIVET KIT HAS RIVETS WITH HOLLOW ENDS WHICH ARE FLARED WHEN INSTALLED

HARD TOP LATCHES KIT

POLISHED OVAL HEAD	6-4520 10.50
--------------------	--------------

INSIDE HARD TOP TRIM KIT

POLISHED OVAL HEAD	6-4521 7.00
--------------------	-------------

BODY MOUNT KITS - SUPPLEMENT TO FRONT MOUNT: 1953-57:

HEX HEAD	# 9-6441 \$ 26.25
SOCKET HEAD	9-6442 27.75
SIX POINT - HIGH STRENGTH	9-6445 84.00
TWELVE POINT - HIGH STRENGTH	9-6446 87.25

1958-62:

HEX HEAD	6-4523 27.50
SOCKET HEAD	6-4528 28.00
SIX POINT - HIGH STRENGTH	6-4561 85.00
TWELVE POINT - HIGH STRENGTH	6-4562 88.00

ENGINE KITS - SEE PAGES 19-23

ENGINE MOUNT TO FRAME KIT

SIX POINT - HIGH STRENGTH	6-4522 39.50
---------------------------	--------------

REAR COVER KITS - SEE PAGE 33

STEERING BOX COVER & MOUNT KITS

SIX POINT - HIGH STRENGTH	6-4554 52.50
TWELVE POINT - HIGH STRENGTH	6-4555 54.75

SUSPENSION KITS - HIGH STRENGTH

FRONT SUSPENSION:

SIX POINT - POLISHED	6-4556 443.50
TWELVE POINT - POLISHED	6-4568 462.00

REAR SUSPENSION:

1953-55:

SIX POINT - POLISHED	6-4558 302.75
TWELVE POINT - POLISHED	6-4559 315.75

1956:

SIX POINT - POLISHED	6-4568 303.75
TWELVE POINT - POLISHED	6-4569 317.25

1957-58:

SIX POINT - POLISHED	6-4570 309.00
TWELVE POINT - POLISHED	6-4563 328.50

1959:

SIX POINT - POLISHED	6-4564 361.50
TWELVE POINT - POLISHED	6-4565 395.25

1960-62:

SIX POINT - POLISHED	6-4566 435.75
TWELVE POINT - POLISHED	6-4567 442.25

- SEE PAGE 130 FOR CASTLE NUTS -

TRANSMISSION KITS - SEE PAGE 29-31

TOLL FREE ORDER LINE : 1-800-767-4781

KITS FOR 1963-1967 CORVETTE

BODY KIT- Each Body Kit includes component kits for Battery Tray/Inner Shields, Back Up & Tail Lights, Brake & Fuel Lines, Cowl Vents, Door Catches, Door Hinges, Door Jambs, Firewall, Floor Pan Shields, Front Bumper & Mount, Front Turn Signals, Gas Filler, Gas Tank Mount, Grill(1965-67), Headlights, Hood Hinges & Brace, Horn & Radiator Mount, Interior Trim, Rear Bumpers, Rear License & Bracket, Roll Pan, Seat Mount & Trim, Spare Tire Crossmember, and Washer Tank Bracket/Relay/Regulator Mounts.

	1963-64:		1965-67:	
BUTTON & FLAT SOCKET HEAD	# 6-4652	\$ 355.00	# 6-4630	\$ 365.75
ORIGINAL STYLE-INDENTED HEX HEAD	6-4601	455.00	6-4602	470.25
WITH BLACK STAINLESS (WHERE APPROPRIATE)				
12 POINT(POLISHED) W/ BUTTON SHEET METAL SCREWS & FLAT SOCKET HEAD	6-4654	1066.00	6-4655	1254.75

** NOTE ORIGINAL STYLE and 12 POINT BOLTS ARE MADE IN USA **

ACCESSORY KITS (NOT INCLUDED IN THE BODY KIT)

BODY MOUNT KITS

1963:

HEX HEAD	# 6-4680	\$ 44.25
SOCKET HEAD	6-4681	64.25
SIX POINT - HIGH STRENGTH	6-4682	100.25
TWELVE POINT - HIGH STRENGTH	6-4683	108.25

1964-67 CONVERTIBLE:

HEX HEAD	6-4685	90.00
SOCKET HEAD	6-4686	108.00
SIX POINT - HIGH STRENGTH	6-4688	178.75
TWELVE POINT - HIGH STRENGTH	6-4687	181.25

1964-67 COUPE:

HEX HEAD	6-4626	63.75
SOCKET HEAD	6-4649	95.50
SIX POINT - HIGH STRENGTH	6-4661	160.50
TWELVE POINT - HIGH STRENGTH	6-4657	161.00

ENGINE KITS - SEE PAGES 17-21

HIDDEN DOOR HINGE BOLTS KIT

ORIGINAL STYLE (32 BOLTS)	# 6-4684	\$47.50
---------------------------	----------	---------

SIDE OUTLET EXHAUST KIT

ORIGINAL STYLE	6-4629	13.75
----------------	--------	-------

SUSPENSION KITS - SIX POINT - POLISHED

CASTLE NUTS NOT INCLUDED - SEE PAGE 130

FRONT SUSPENSION - HIGH STRENGTH	6-4796	447.75
REAR SUSPENSION - HIGH STRENGTH	6-4799	589.75

TRANSMISSION KITS -SEE PAGE 29-31

KITS FOR 1968-1976 CORVETTE

BODY KIT- Every Body Kit includes component kits for Brake, Fuel & Emergency Brake Lines, Cowl Vent/Wiper Cover, Door Hinges, Door Jambs, Firewall (misc.), Firewall Access Cover, Front Air Spoiler, Front Bumper & Mount, Front Crossmember, Front License Plate & Brackets, Gas Tank Mount, Grill & Front Turn Signals, Headlights, Heater/AC Box, Hood Hinges & Brace, Hood Latches & Catches, Inner Fender Shields, Tanks, Interior, Nose Reinforcing Braces, Radiator Support & Shroud, Rear Bumper, Rear License & Bracket, Roll Pan, Seat Mount & Trim, Tail Light, and Wiper Linkage, etc.

	1968-69:		1970-72:		1973:	
BUTTON HEAD & FLAT SOCKET HEAD	# 6-4754	\$ 375.00	# 6-4755	\$380.00	# 6-4742	\$ 350.00
ORIGINAL STYLE - INDENTED HEX HEAD*	6-4702	465.75	6-4703	470.00	6-4743	505.50
	1974:		1975:		1976:	
BUTTON HEAD & FLAT SOCKET HEAD	6-4744	355.00	6-4746	455.00	6-4748	460.50
ORIGINAL STYLE - INDENTED HEX HEAD*	6-4745	470.50	6-4747	520.75	6-4749	535.00

* WITH BLACK STAINLESS (WHERE APPROPRIATE) ** ORIGINAL STYLE BOLTS ARE MADE IN USA **

ACCESSORY KITS (NOT INCLUDED IN THE BODY KIT)

BODY MOUNT KITS - SUPPLEMENT TO FRONT MOUNT (FOR STOCK TYPE MOUNTS):

1968-72:

HEX HEAD	# 6-4730	\$ 55.50
SOCKET HEAD	6-4739	76.50
SIX POINT - HIGH STRENGTH	6-4740	117.25
TWELVE POINT - HIGH STRENGTH	6-4741	123.75

1973-82:

HEX HEAD	6-4790	50.50
SOCKET HEAD	6-4791	75.00
SIX POINT - HIGH STRENGTH	6-4792	129.75
TWELVE POINT - HIGH STRENGTH	6-4793	132.00

DOOR STRIKER BOLTS & WASHERS

SOCKET HEAD (PAIR)	# 6-8154	\$ 59.95
--------------------	----------	----------

ENGINE KITS - SEE PAGES 19-23

REAR END COVER KITS - SEE PAGE 31

SUSPENSION KITS - SEE PAGE 130 FOR CASTLE NUTS -

SIX POINT HEAD STYLE - HIGH STRENGTH

FRONT SUSPENSION (63-82)	6-4796	447.75
REAR SUSPENSION (63-79)	6-4799	589.75

TRANSMISSION KITS - SEE PAGE 29-31

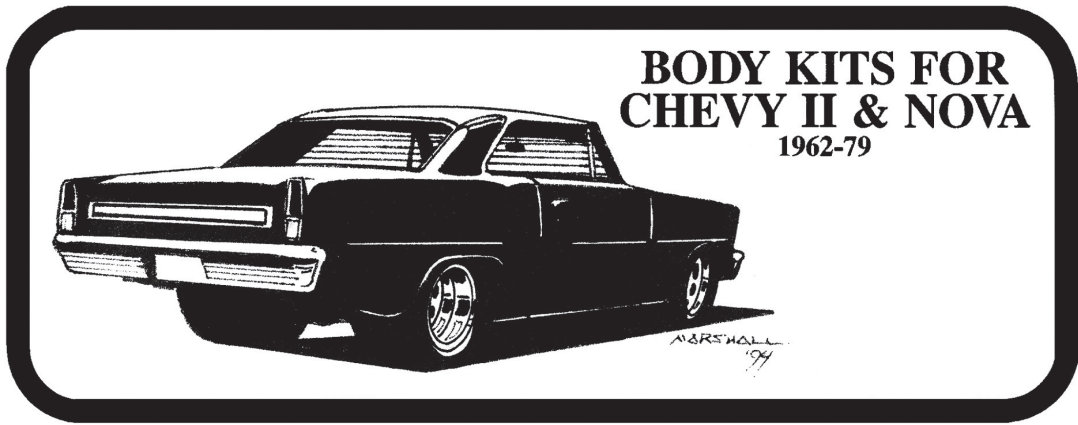

KITS FOR 1962-1965 CHEVY II

BODY KIT- Every Body Kit includes component kits for Bumpers, Cross Member, Door Hinges & Latch, Door Jambs, Front Fenders, Front Seat Mounts, Hood Hinges & Latch & Catch, Inner Fender, Hood Stops & Shock Towers, Interior Trim Screw, Master Cylinder & Windshield Washer Tank, Radiator Support, Battery Box, & Horns, Tail Light, and Trunk Hinges & Latch & Catch. Available in 4 different bolt styles!

Contains one of each component kit

	HARD TOP:		SEDAN:		STATION WAGON:	
BUTTON AND SOCKET HEAD	#6-7087	\$310.50	# 6-7000	\$ 305.00	# 6-7083	\$380.00
HEX HEAD	6-7088	315.75	6-7001	315.75	6-7084	390.75
INDENTED HEX HEAD	6-7089	370.00	6-7002	365.00	6-7085	440.00
ORIGINAL STYLE	6-7090	405.50	6-7041	405.50	6-7086	470.50
INDENTED HEX WITH BLACK STAINLESS (WHERE APPROPRIATE)						
SIX POINT- HIGH STRENGTH - POLISHED	6-7093	729.50				

** NOTE SIX POINT, INDENTED HEX, & ORIGINAL STYLE BOLTS ARE MADE IN USA **

ACCESSORY KITS (NOT INCLUDED IN THE BODY KIT)

ENGINE KITS - SEE PAGES 17-20

REAR END COVER KITS - SEE PAGE 31

TRANSMISSION KITS - SEE PAGE 29-31

REAR DOORS KIT - FOR FOUR DOOR CARS

-THESE ARE INCLUDED IN THE STATION WAGON KITS! -

FLAT SOCKET & PHILLIPS HEAD	# 6-7091	\$ 34.50
PHILLIPS FLAT & PAN HEAD	6-7092	32.50

KITS FOR 1966-1967 NOVA

BODY KIT- Every Body Kit includes component kits for Bumpers, Door Hinges, Door Jambs & Sill, Front Fenders, Front Seat Mount, Grill, Headlight Bezels & Turn Signals, Hood Hinges & Latch & Catch, Inner Fenders, Interior Trim, Master Cylinder, Radiator Support, Seat Mount, Shock Towers, and Trunk Hinges. Comes in four different head styles including Original Style with black stainless where appropriate!

Contains one of each component kit

	HARD TOP:		SEDAN:		STATION WAGON:	
BUTTON AND SOCKET HEAD	# 6-7156	\$310.75	# 6-7100	\$ 300.75	# 6-7150	\$ 410.00
HEX HEAD	6-7157	315.50	6-7101	310.75	6-7151	415.75
INDENTED HEX HEAD	6-7158	365.50	6-7102	360.50	6-7152	460.50
ORIGINAL STYLE-INDENTED HEX	6-7159	380.75	6-7125	365.00	6-7153	470.00

WITH BLACK STAINLESS WHERE APPROPRIATE

** NOTE INDENTED HEX, & ORIGINAL STYLE BOLTS ARE MADE IN USA **

ACCESSORY KITS (NOT INCLUDED IN THE BODY KIT)

ENGINE KITS - SEE PAGES 19-23

REAR DOORS KIT - FOR FOUR DOOR CARS

-THESE ARE INCLUDED IN THE STATION WAGON KITS! -

FLAT SOCKET & PHILLIPS HEAD	# 6-7154	\$ 42.00
PHILLIPS FLAT & PAN HEAD	6-7155	42.50

REAR END COVER KITS - SEE PAGE 31

SUBFRAME MOUNT FOR HEIDT'S KIT

SIX POINT - HIGH STRENGTH	6-6999	138.50
---------------------------	--------	--------

SUBFRAME MOUNT FOR TCI KIT

SIX POINT - HIGH STRENGTH	6-7099	208.50
---------------------------	--------	--------

TRANSMISSION KITS - SEE PAGE 29-31

TOLL FREE ORDER LINE : 1-800-767-4781



KITS FOR 1968-1974 NOVA

BODY KIT- Each includes component kits for Body Mount, Bumpers, Door Hinges (68-72), Door Jambs, Fuel Tank, Grill (68-72), Headlight Bezels & Turn Signals, Hood Hinges & Latch & Catch, Interior Trim, License Plate & Bracket, Radiator Support, Inner & Outer Fenders, Battery Box, & Horn, Seat Mount (68-72), and Trunk Hinges, Latch & Catch. Comes in SIX different head styles including Original Style with black stainless where appropriate!

Contains one of each component kit

	1968-72		1973-74	
BUTTON AND SOCKET HEAD	# 6-7204	\$ 255.75	# 6-7250	\$ 220.00
HEX HEAD	6-7209	260.00	6-7251	225.00
INDENTED HEX HEAD	6-7216	295.00	6-7252	250.00
ORIGINAL STYLE- INDENTED HEX	6-7221	340.00	6-7253	300.00
WITH BLACK STAINLESS WHERE APPROPRIATE				
SIX POINT - HIGH STRENGTH - POLISHED	6-7248	727.50	6-7254	675.50
TWELVE POINT - HIGH STRENGTH - POLISHED	6-7249	766.50	6-7255	704.00

** NOTE INDENTED HEX, ORIGINAL STYLE, 6 & 12 POINT BOLTS ARE MADE IN USA **

ACCESSORY KITS (NOT INCLUDED IN THE BODY KIT)

CHASSIS KIT - INCLUDES ALL KITS WITH AN *

BESIDE THE TITLE - HIGH STRENGTH		
SIX POINT - POLISHED	# 6-1680	\$ 888.75
TWELVE POINT - POLISHED	6-1684	902.75

SUSPENSION KITS* - HIGH STRENGTH BOLTS COMPLETE WITH COTTER PINS AND GREASE FITTINGS,

CASTLE NUTS NOT INCLUDED - SEE PAGE 130

FRONT SUSPENSION - SIX POINT	6-1681	362.25
FRONT SUSPENSION - 12 POINT	6-1676	373.75
REAR SUSPENSION - SIX POINT	6-1687	284.00
REAR SUSPENSION - TWELVE POINT	6-1683	289.75

STEERING BOX COVER & MOUNT KITS*

SIX POINT - HIGH STRENGTH	6-1607	60.00
TWELVE POINT - HIGH STRENGTH	6-1613	62.50

TRANSMISSION CROSSMEMBER KITS*

SIX POINT - HIGH STRENGTH	6-1768	35.25
TWELVE POINT - HIGH STRENGTH	6-1771	37.50

SUBFRAME MOUNT KIT*

SIX POINT - HIGH STRENGTH	6-1699	\$ 148.50
---------------------------	--------	-----------

DOOR STRIKER BOLTS & WASHERS

SOCKET HEAD (PAIR)	6-8154	59.95
--------------------	--------	-------

ENGINE KITS - SEE PAGES 19-23

ENGINE MOUNT KITS

SIX POINT - HIGH STRENGTH	6-1945	40.50
TWELVE POINT - HIGH STRENGTH	6-1946	44.25

REAR END COVER KITS - SEE PAGE 31

TRANSMISSION KITS - SEE PAGE 29

KITS FOR 1975-1979 NOVA

BODY KIT- Each includes component kits for Bumpers, Door Latches, Fenders, Front Body Mount, Grill & Headlight Bezel, Hood Hinges & Latch & Catch, Interior Trim, Master Cylinder, Radiator Support & Battery Box, Seat Mount, and Trunk Hinges, Latch & Catch. Comes in six different head styles including Original Style with black stainless where appropriate!

Contains one of each component kit

BUTTON AND SOCKET HEAD	# 6-7800	\$ 175.00
HEX HEAD	6-7801	180.50
INDENTED HEX HEAD	6-7802	215.75
ORIGINAL STYLE-INDENTED HEX	6-7803	245.50
WITH BLACK STAINLESS WHERE APPROPRIATE		
SIX POINT - HIGH STRENGTH - POLISHED	6-7804	425.75
TWELVE POINT - HIGH STRENGTH - POLISHED	6-7809	457.75

** NOTE INDENTED HEX, ORIGINAL STYLE, 6 POINT & 12 POINT BOLTS ARE MADE IN USA **

ACCESSORY KITS (NOT INCLUDED IN THE BODY KIT)

ENGINE KITS - SEE PAGES 19-23

SUSPENSION KITS- COMPLETE WITH COTTER PINS AND GREASE FITTINGS, **CASTLE NUTS NOT INCLUDED - SEE PAGE 3**

FRONT SUSPENSION - HIGH STRENGTH	#6-7839	\$ 447.00
REAR SUSPENSION - HIGH STRENGTH	6-1688	299.75

REAR END COVER KITS - SEE PAGE 31

TRANSMISSION KITS - SEE PAGE 29

DOOR STRIKER BOLTS & WASHERS

SOCKET HEAD (PAIR)	# 6-8149	\$ 65.00
--------------------	----------	----------

SUB FRAME MOUNT KIT

SIX POINT - HIGH STRENGTH	6-1699	148.50
---------------------------	--------	--------



BODY KITS FOR CHEVROLET TRUCKS

1941 - Early 1955

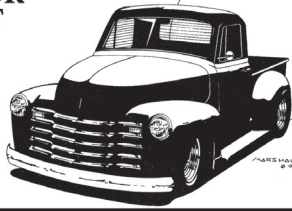

BEDLESS BODY KITS

1941 - EARLY 47:		
BUTTON/FLAT SOCKET	# 6-9750	\$ 200.00
HEX HEAD & SLOTTED HEAD	6-9751	240.50
LATE 1947-51:		
BUTTON/FLAT SOCKET HEAD	6-7381	225.00
HEX & PHILLIPS HEAD	6-7382	220.50
INDENTED HEX - ORIGINAL STYLE	6-7383	255.75
1952-53:		
BUTTON/FLAT SOCKET HEAD	6-7384	225.75
HEX & PHILLIPS HEAD	6-7385	220.75
INDENTED HEX - ORIGINAL STYLE	6-7386	255.50
1954 - EARLY 55:		
BUTTON/ FLAT SOCKET HEAD	6-7387	225.75
HEX & PHILLIPS HEAD	6-7388	230.50
INDENTED HEX - ORIGINAL STYLE	6-7389	295.00

BODY KITS WITH A LONG BED

LATE 1947-51:		
BUTTON/FLAT SOCKET HEAD	# 6-1170	\$ 420.00
HEX & PHILLIPS HEAD	6-1171	415.75
INDENTED HEX - ORIGINAL STYLE	6-1172	460.50
1952-53:		
BUTTON/FLAT SOCKET HEAD	6-1178	415.00
HEX & PHILLIPS HEAD	6-1179	410.75
INDENTED HEX - ORIGINAL STYLE	6-1180	455.25
1954 - EARLY 55:		
BUTTON/FLAT SOCKET HEAD	6-1186	415.00
HEX & PHILLIPS HEAD	6-1187	420.75
INDENTED HEX - ORIGINAL STYLE	6-1188	490.75

BODY KITS WITH A SHORT BED

1941 - EARLY 1947:		
BUTTON/FLAT SOCKET HEAD	# 6-9749	\$ 350.75
HEX & SLOTTED HEAD	6-9752	360.00
LATE 1947-51:		
BUTTON/FLAT SOCKET HEAD	6-1166	390.75
HEX & PHILLIPS HEAD	6-1167	385.00
INDENTED HEX - ORIGINAL STYLE	6-1168	430.25
1952-53:		
BUTTON/FLAT SOCKET HEAD	6-1174	385.00
HEX & PHILLIPS HEAD	6-1175	380.75
INDENTED HEX - ORIGINAL STYLE	6-1176	430.50
1954 - EARLY 55:		
BUTTON/FLAT SOCKET HEAD	6-1182	380.00
HEX & PHILLIPS HEAD	6-1183	390.50
INDENTED HEX - ORIGINAL STYLE	6-1184	465.50

BODY KITS FOR PANEL TRUCKS

LATE 1947-51:		
BUTTON/FLAT SOCKET HEAD	# 6-1546	\$ 465.00
HEX & PHILLIPS HEAD	6-1547	455.00
INDENTED HEX - ORIGINAL STYLE	6-1548	495.25
1952-53:		
BUTTON/FLAT SOCKET HEAD	6-1549	390.50
HEX & PHILLIPS HEAD	6-1550	380.00
INDENTED HEX - ORIGINAL STYLE	6-1551	420.50
1954 - EARLY 55:		
BUTTON/FLAT SOCKET HEAD	6-1574	400.75
HEX & PHILLIPS HEAD	6-1575	410.50
INDENTED HEX - ORIGINAL STYLE	6-1576	470.50

BODY KIT- Every Body Kit includes component kits for Front Bumper, Door Hinges, Door Latch & Catch, Fender to Firewall Brace Rods, Front & Inner Fenders, Grill & Gravel Pan, Headlight & Parking Lens, Hood Hinges, Hood Latch, Catch & Braces, Interior, Outside Mirror, Radiator Support, and Regulator & Relay.

Body kits with a bed also include kits for: Bed Mounts, Bed Strips, Front Bed Panel, Rear Fenders, Rear Bed Crossmember, Running Boards Tail Lights & Rear Posts and Tailgate Mounting.

BED KITS - USED IN KITS LISTED WITH BEDS

1941-EARLY 1947:			
BUTTON HEAD		# 6-9764	\$ 175.00
HEX HEAD		6-9765	170.00
LATE 1947-51: SHORT BED LONG BED*			
BUTTON HEAD	6-1111	190.50	6-1154 220.50
HEX HEAD	6-1131	199.50	6-1155 215.50
INDENTED HEX	6-1140	215.50	6-1156 230.75
1952-53: SHORT BED LONG BED*			
BUTTON HEAD	6-1177	180.50	6-1154 220.50
HEX HEAD	6-1189	185.50	6-1155 215.50
INDENTED HEX	6-1181	195.25	6-1156 230.00
`54-EARLY 55: SHORT BED LONG BED			
BUTTON HEAD	6-1157	185.00	6-1165 220.25
HEX HEAD	6-1161	190.00	6-1169 215.50
INDENTED HEX	6-1164	200.75	6-1173 230.00

* LONG BED KIT IS THE SAME LATE 1947-53

NOTE - IF YOU WANT POLISHED BED BOLTS, ORDER A BEDLESS KIT AND ONE OF THE BED KITS LISTED BELOW:

BED KITS - WITH POLISHED BED STRIP BOLTS & BED MOUNT BOLTS:

1941-EARLY 1947:			
BUTTON HEAD		6-9764P	235.00
HEX HEAD		6-9765P	230.00
LATE 1947-51: SHORT BED LONG BED*			
BUTTON HEAD	6-1111P	290.00	6-1154P 335.00
HEX HEAD	6-1131P	285.00	6-1155P 330.00
INDENTED HEX	6-1140P	305.00	6-1156P 360.50
1952-53: SHORT BED LONG BED*			
BUTTON HEAD	6-1177P	265.00	6-1154P 335.00
HEX HEAD	6-1189P	260.00	6-1155P 330.00
INDENTED HEX	6-1181P	280.00	6-1156P 360.50
`54-EARLY 55: SHORT BED LONG BED			
BUTTON HEAD	6-1157P	285.00	6-1165P 330.00
HEX HEAD	6-1161P	280.00	6-1169P 325.00
INDENTED HEX	6-1164P	305.00	6-1173P 360.50

** NOTE ORIGINAL STYLE INDENTED HEX BOLTS ARE MADE IN USA **

BODY KITS FOR SUBURBANS

LATE 1947-51:		
BUTTON/FLAT SOCKET HEAD	# 6-6406	\$ 385.75
INDENTED HEX - ORIGINAL STYLE	6-6407	420.25
1952-53:		
BUTTON/FLAT SOCKET HEAD	6-6408	385.75
INDENTED HEX - ORIGINAL STYLE	6-6409	420.50
1954 - EARLY 55:		
BUTTON/FLAT SOCKET HEAD	6-6410	385.75
INDENTED HEX - ORIGINAL STYLE	6-6412	460.50

**CUSTOM MADE FLAT TOP
CARRIAGE BOLTS FOR PANEL TRUCK
BED STRIPS # 2-0799 \$5.75 EA
(INCLUDED IN PANEL TRUCK KITS)**



-SEE NEXT PAGE FOR ACCESSORY KITS-

ACCESSORY KITS (NOT INCLUDED IN THE BODY KIT)

CAB MOUNT KIT - LATE 1947-EARLY 1955

INCLUDED IN THE KITS FOR PANEL TRUCKS & SUBURBANS

SIX POINT & HEX # 6-1199 \$ 46.50

ENGINE KITS - SEE PAGES 17-21

FRONT BED PANEL ROD - FOR LATE 1947-1953

51 1/4" LONG ROD WITH NUTS 6-1125 48.75

REAR END COVER KITS - SEE PAGE 31

TRANSMISSION KITS - SEE PAGE 29-31

HOOD HINGE SHOULDER BOLTS - L47-E55

BUTTON HEAD # 6-1132 \$ 121.00

HEX HEAD 6-1133 126.00

BODY KITS FOR CHEVROLET TRUCK Late 1955 - 1966

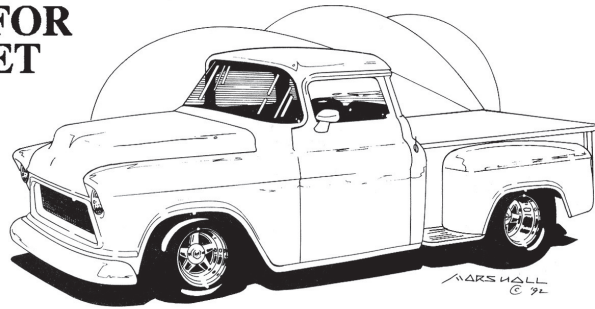

KITS FOR 1955-1959 CHEVY TRUCK

BODY KIT- Every Body Kit includes component kits for Bumper, Door Hinges, Door Latch & Catch, Firewall, Cowl, & Battery Box, Front & Inner Fenders, Headlight & Front Lens, Hood Hinges, Hood Braces, Interior, Outside Mirrors, Seat Mount, Radiator Support, Hood Latch, Splash Pan and Front Mounts. Body kits with a bed also include all the appropriate bed component kits, see listings under bed kits on the next page.

** NOTE ORIGINAL STYLE INDENTED HEX BOLTS ARE MADE IN USA **

BEDLESS BODY KIT

LATE 1955 *

BUTTON/FLAT SOCKET HEAD	# 6-7321	\$ 235.00
HEX & PHILLIPS HEAD	6-7322	230.75
INDENTED HEX HEAD	6-7324	290.75

1956-57

BUTTON/FLAT SOCKET HEAD	6-1235	240.75
HEX & PHILLIPS HEAD	6-1236	225.00
INDENTED HEX HEAD	6-1238	285.00

1958-59

BUTTON/FLAT SOCKET HEAD	6-1291	250.50
HEX & PHILLIPS HEAD	6-1292	235.00
INDENTED HEX HEAD	6-1294	280.00

BODY KITS WITH A CAMEO BED

LATE 1955 *

BUTTON/FLAT SOCKET HEAD	6-7349	530.50
INDENTED HEX & PHILLIPS HEAD	6-7353	620.50

1956-57

BUTTON/FLAT SOCKET HEAD	6-7357	545.50
INDENTED HEX HEAD	6-7373	615.50

1958

BUTTON/FLAT SOCKET HEAD	6-7378	550.50
INDENTED HEX HEAD	6-7379	615.00

BODY KITS FOR PANEL TRUCKS

LATE 1955*

BUTTON HEAD	6-7685	465.75
HEX HEAD	6-7787	460.75
INDENTED HEX HEAD	6-7788	525.25

1956-1957

BUTTON HEAD	6-7794	475.75
HEX HEAD	6-7795	455.00
INDENTED HEX HEAD	6-7796	525.25

1958-1959

BUTTON HEAD	6-7797	475.75
HEX HEAD	6-7798	455.00
INDENTED HEX HEAD	6-7799	520.25

*** NOTE: BEFORE ORDERING A LATE 1955 KIT, CHECK THE DOOR HINGE AND RADIATOR TO FRAME BOLTS - LATE 1955 TRUCKS USE CARRIAGE BOLTS ON THESE ITEMS, IF YOUR TRUCK HAS HEX HEAD BOLTS, ORDER A 56-57 KIT**

BODY & LONG STEPSIDE BED KITS

LATE 1955 *

BUTTON/FLAT SOCKET HEAD	# 6-7327	\$ 455.00
HEX & PHILLIPS HEAD	6-7328	450.00
INDENTED HEX HEAD	6-7329	520.00

1956-57

BUTTON/FLAT SOCKET HEAD	6-1894	455.00
HEX & PHILLIPS HEAD	6-1895	440.50
INDENTED HEX HEAD	6-1896	510.50

1958-59

BUTTON/FLAT SOCKET HEAD	6-1884	465.00
HEX & PHILLIPS HEAD	6-1885	455.00
INDENTED HEX HEAD	6-1886	520.75

BODY & SHORT STEPSIDE BED KITS

LATE 1955 *

BUTTON/FLAT SOCKET HEAD	6-7330	445.50
HEX & PHILLIPS HEAD	6-7331	430.00
INDENTED HEX HEAD	6-7332	505.75

1956-57

BUTTON/FLAT SOCKET HEAD	6-1890	445.00
HEX & PHILLIPS HEAD	6-1891	430.50
INDENTED HEX HEAD	6-1892	505.50

1958-59

BUTTON/FLAT SOCKET HEAD	6-1880	450.00
HEX & PHILLIPS HEAD	6-1881	440.00
INDENTED HEX HEAD	6-1882	510.00

1958-59 BODY & FLEETSIDE BED KITS

BUTTON/FLAT SOCKET HEAD	6-7346	445.00
HEX & PHILLIPS HEAD	6-7347	425.50
INDENTED HEX HEAD	6-7348	495.00

50 BED KIT- Every Bed Kit includes component kits for Bed Mounts, Bed Strips & Angles, Front Bed Panel, Rear Bumper, Tail Gate, and Tail Lights. Cameo Bed kits also have Rear Fender Braces, Rear Fender Front Panels, Rear Panel & Tail Gate, Spare Tire Carrier & Cover, and Top Rails kits. Fleetside Bed kits also contain kits for Inner Fenders & Side Angles and Rear Fender Braces. Stepside beds also have kits for License Plate & Bracket, Side Steps, and Rear Fenders. **** NOTE ORIGINAL STYLE INDENTED HEX BOLTS ARE MADE IN USA ****
 -COMPLETE BED KITS CONTAIN UNPOLISHED BOLTS UNLESS STATED OTHERWISE-

CAMEO BED KITS

BUTTON/FLAT SOCKET HEAD # 6-1250 \$ 325.00
 INDENTED HEX HEAD - ORIGINAL STYLE 6-1273 355.00

BEDS WITH POLISHED BED FLOOR BOLTS:

BUTTON/FLAT SOCKET HEAD 6-1250P 435.00
 INDENTED HEX HEAD - ORIGINAL STYLE 6-1273P 465.50

FLEETSIDE BED KITS (1958-59)

BUTTON & CARRIAGE HEAD 6-7342 220.75
 HEX & CARRIAGE HEAD 6-7343 215.00
 INDENTED HEX & CARRIAGE HEAD 6-7344 240.25

BEDS WITH POLISHED BED FLOOR BOLTS:

BUTTON & CARRIAGE HEAD 6-7342P 350.75
 HEX & CARRIAGE HEAD 6-7343P 345.00
 INDENTED HEX & CARRIAGE HEAD 6-7344P 370.25

LONG STEPSIDE BED KITS

BUTTON/FLAT SOCKET HEAD # 6-1248 \$240.50
 HEX & CARRIAGE HEAD 6-1263 235.75
 INDENTED HEX & CARRIAGE HEAD 6-1249 260.75

BEDS WITH POLISHED BED FLOOR BOLTS:

BUTTON/FLAT SOCKET HEAD 6-1248P 345.50
 HEX & CARRIAGE HEAD 6-1263P 335.75
 INDENTED HEX & CARRIAGE HEAD 6-1249P 370.75

SHORT STEPSIDE BED KITS

BUTTON & CARRIAGE HEAD 6-1241 225.75
 HEX & CARRIAGE HEAD 6-1246 220.50
 INDENTED HEX & CARRIAGE HEAD 6-1247 250.00

BEDS WITH POLISHED BED FLOOR BOLTS:

BUTTON & CARRIAGE HEAD 6-1241P 325.50
 HEX & CARRIAGE HEAD 6-1246P 320.75
 INDENTED HEX & CARRIAGE HEAD 6-1247P 350.00

ACCESSORY KITS (NOT INCLUDED IN THE BODY & BED KITS)

CAB MOUNT BOLT KIT - INCLUDED IN PANEL TRUCK KIT

HEX HEAD # 6-7398 \$ 28.75

ENGINE FASTENER KITS - SEE PAGE 17-21

EXTRA BED MOUNT HARDWARE

- FOR TRUCKS WITH MORE THAN 8 BED MOUNT BOLTS
 - INCLUDES (2) BOLTS, NUTS, LOCKS & WASHERS

CARRIAGE HEAD 6-1298 12.75
 POLISHED CARRIAGE HEAD 6-1298P 19.00

HOOD HINGE RIVET REPLACEMENT KIT:

(10) SHOULDERED RIVETS & THIN LOCK NUTS 6-7767 229.00

INNER WINDOW TRIM - FOR SUBURBAN

PHILLIPS OVAL 6-1293 10.75

ORIGINAL TYPE REAR COVER KITS

HEX HEAD (3/8 -24) 6-5571 12.00

-SEE PAGE 33 FOR DANA REAR COVERS

**SPARE TIRE COVER BOLTS FOR CAMEO
 -THESE ARE INCLUDED IN THE BED KITS! -**

BUTTON HEAD (SET OF 2) 6-7737 32.50
 HEX FLANGED POLISHED (2) 6-1212 34.00

**KIT FOR ORIGINAL STYLE CHASSIS
 INCLUDES STEERING BOX KIT**

HEX HEAD & SIX POINT 6-7403 225.00

STEERING BOX KIT

HEX HEAD 6-7395 24.50

KITS FOR 1960-1966 CHEVY TRUCKS

BODY KIT- Every Body Kit includes component kits for Bumper, Cowl, Door Hinges, Door Jambs, Sills, & Latches, Firewall, Master Cylinder, & Steering Column, Front & Inner Fenders, Headlight, & Front Signals, Hood Braces, Hood Hinges, Hood Latch, Interior, Radiator Support, & Battery Box, Outside Mirrors, and Seat Mount. Body kits with a bed also include all the appropriate bed component kits, see listings under bed kits on the next page. **** NOTE INDENTED HEX, & ORIGINAL STYLE BOLTS ARE MADE IN USA ****

BEDLESS BODY KITS

BUTTON & SOCKET HEAD # 6-1340 \$ 250.00
 HEX HEAD 6-1376 265.75
 INDENTED HEX HEAD 6-1377 330.00
 ORIGINAL STYLE-INDENTED HEX 6-1580 375.75
 WITH BLACK STAINLESS WHERE APPROPRIATE

****IF YOU HAVE A PANEL OR FLAT BED TRUCK, ORDER A BEDLESS BODY KIT - IF YOU WANT POLISHED BED FLOOR BOLTS, ORDER A BEDLESS KIT & A BED KIT WITH POLISHED BED FLOOR BOLTS (ON NEXT PAGE)**

BODY & LONG FLEETSIDE BED KITS

BUTTON & SOCKET HEAD 6-7370 465.75
 HEX HEAD 6-7371 465.50
 INDENTED HEX HEAD 6-7372 540.50
 ORIGINAL STYLE-INDENTED HEX 6-1581 565.25
 WITH BLACK STAINLESS WHERE APPROPRIATE

BODY & SHORT FLEETSIDE BED KITS

BUTTON & SOCKET HEAD # 6-7354 \$ 450.00
 HEX HEAD 6-7355 460.00
 INDENTED HEX HEAD 6-7356 530.50
 ORIGINAL STYLE-INDENTED HEX 6-1583 560.75
 WITH BLACK STAINLESS WHERE APPROPRIATE

BODY & LONG STEPSIDE BED KITS

BUTTON & SOCKET HEAD 6-1825 460.75
 HEX HEAD 6-1826 475.00
 INDENTED HEX HEAD 6-1827 540.75
 ORIGINAL STYLE- INDENTED HEX 6-1582 565.00
 WITH BLACK STAINLESS WHERE APPROPRIATE

BODY & SHORT STEPSIDE BED KITS

BUTTON & SOCKET HEAD 6-1821 450.00
 HEX HEAD 6-1822 460.00
 INDENTED HEX HEAD 6-1823 525.50
 ORIGINAL STYLE-INDENTED HEX 6-1584 570.75
 WITH BLACK STAINLESS WHERE APPROPRIATE

BED KITS FOR 1960-1966 CHEVY TRUCKS

Each Complete Bed Kit includes component kits for Bed Mounts, Bed Strips & Angles, Fenders, Front Bed Panel, Rear Bumper, Tail Lights, and Tail Gate. Fleetside bed kits also include Inner Fender & Side Angles, and Rear Fender Braces kits. Stepside bed kits also include kits for Side Steps, and Rear Fenders.

LONG FLEETSIDE BED KITS

BUTTON & CARRIAGE HEAD	# 6-7375	\$ 240.00
HEX & PHILLIPS HEAD	6-7376	225.00
INDENTED HEX & PHILLIPS HEAD	6-7377	260.50

BEDS WITH POLISHED BED FLOOR BOLTS:

BUTTON & CARRIAGE HEAD	6-7375P	360.00
HEX & PHILLIPS HEAD	6-7376P	355.00
INDENTED HEX & PHILLIPS HEAD	6-7377P	370.50

LONG STEPSIDE BED KITS

BUTTON & CARRIAGE HEAD	6-1834	235.75
HEX & PHILLIPS HEAD	6-1835	230.50
INDENTED HEX & PHILLIPS HEAD	6-1836	250.50

BEDS WITH POLISHED BED FLOOR BOLTS:

BUTTON & CARRIAGE HEAD	6-1834P	340.50
HEX & PHILLIPS HEAD	6-1835P	335.00
INDENTED HEX & PHILLIPS HEAD	6-1836P	355.75

SHORT FLEETSIDE BED KITS

BUTTON & CARRIAGE HEAD	# 6-7366	\$ 225.00
HEX & PHILLIPS HEAD	6-7367	220.75
INDENTED HEX & PHILLIPS HEAD	6-7368	240.25

BEDS WITH POLISHED BED FLOOR BOLTS:

BUTTON & CARRIAGE HEAD	6-7366P	340.00
HEX & PHILLIPS HEAD	6-7367P	340.00
INDENTED HEX & PHILLIPS HEAD	6-7368P	360.00

SHORT STEPSIDE BED KITS

BUTTON & CARRIAGE HEAD	6-1337	225.50
HEX & PHILLIPS HEAD	6-1338	220.75
INDENTED HEX & PHILLIPS HEAD	6-1339	245.25

BEDS WITH POLISHED BED FLOOR BOLTS:

BUTTON & CARRIAGE HEAD	6-1337P	310.50
HEX & PHILLIPS HEAD	6-1338P	305.75
INDENTED HEX & PHILLIPS HEAD	6-1339P	325.00

ACCESSORY KITS (NOT INCLUDED IN THE BODY & BED KITS)

CAB MOUNT KIT

HEX - PICKUP	# 6-7467	\$ 57.25
CARRIAGE/HEX - PANEL	6-7396	82.00

FRONT BODY MOUNT KITS

CARRIAGE HEAD	# 6-7399	\$ 27.00
---------------	----------	----------

ENGINE FASTENER KITS - SEE PAGE 17-21

STEERING BOX KIT - MANUAL BOX

SIX POINT -HIGH STRENGTH	6-7369	44.75
--------------------------	--------	-------

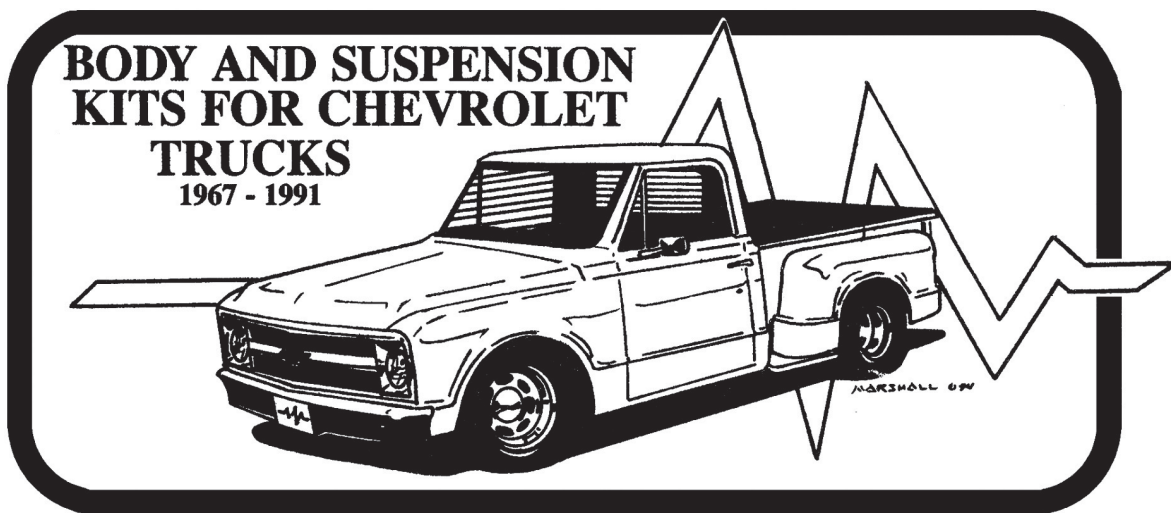

KITS FOR 1967-1972 CHEVY TRUCKS INCLUDING BLAZERS & SUBURBANS

Each Body Kit includes component kits for Battery Box, Bumper, Cowl Cover, Front & Inner Fenders, Door Hinges, Door Jambs & Sills, Door Latches, Headlight Bezels, Front Lens & Side Marker Light, Hood Hinges, Hood Latch, Interior, Outside Mirrors, Radiator Support, and Seat Mounts. Blazer & Suburban Kits include kits for Rear Bumper, Rear Wheel Tubs, Tail Lights, Third door kit for Suburbans, & Top to Body Mount Bolts for Blazer. Body Kits with Beds also include all appropriate bed component kits listed on the next page.

SEE NEXT PAGE FOR BODY & CHASSIS KITS!



TOLL FREE ORDER LINE : 1-800-767-4781

BODY KITS FOR 1967-1972 CHEVY TRUCKS

BEDLESS BODY KITS

BUTTON & FLAT SOCKET HEAD	# 6-1388	\$ 260.00
HEX & PHILLIPS HEAD	6-1389	250.75
INDENTED HEX HEAD	6-1390	295.50
ORIGINAL STYLE-INDENTED HEX	6-1393	340.50
WITH BLACK STAINLESS WHERE APPROPRIATE		
SIX POINT - POLISHED	9-9750	705.50
TWELVE POINT - POLISHED	9-9751	722.75

BODY & FLEETSIDE BED KITS - FOR TRUCKS

WITH METAL FLOOR BEDS

BUTTON & FLAT SOCKET HEAD	6-1866	415.50
HEX HEAD	6-1867	410.00
INDENTED HEX HEAD	6-1868	430.00
ORIGINAL STYLE-INDENTED HEX	6-7435	455.25
WITH BLACK STAINLESS WHERE APPROPRIATE		
SIX POINT & PLAIN CARRIAGE	9-9774	1067.50
TWELVE POINT & CARRIAGE	9-9775	1096.75

BODY KITS FOR BLAZER - 1969-72

BUTTON HEAD	6-1372	375.00
HEX HEAD	6-1373	355.75
INDENTED HEX HEAD	6-1374	390.25
ORIGINAL STYLE - INDENTED HEX	6-1424	430.00
WITH BLACK STAINLESS WHERE APPROPRIATE		

-IF YOU NEED FASTENERS FOR A PANEL OR FLAT BED TRUCK ORDER A BEDLESS BODY KIT-

BED KITS

- Every Bed Kit includes component kits for Bed Mounts, Bed Strips (wood floor beds only) & Angles, Front Bed Panel, Rear Bumper, Tail Lights, and Tail Gate. Fleetside Bed kits also contain kits for: Inner Fenders to Bed & Side angles, Rear Cross Member, and Rear Fender Braces & Inner Fenders to Fenders. Stepside Bed kits also contain kits for Rear Fenders, and Side Steps.

-BED KITS CONTAIN UNPOLISHED BOLTS UNLESS STATED OTHERWISE-

FLEETSIDE BED KITS - ALL METAL BED

BUTTON & CARRIAGE HEAD	# 6-1384	\$ 180.75
HEX & CARRIAGE HEAD	6-1385	185.75
INDENTED HEX HEAD	6-1386	205.75
SIX POINT & CARRIAGE	9-9786	361.25
TWELVE POINT & CARRIAGE	9-9787	374.00

KITS WITH POLISHED BED BOLTS:

BUTTON & CARRIAGE HEAD	6-1384P	240.00
HEX & CARRIAGE HEAD	6-1385P	245.50
INDENTED HEX & CARRIAGE HEAD	6-1386P	260.00
SIX POINT & CARRIAGE	9-9786P	389.25

FLEETSIDE BED KITS - WOOD FLOOR BED

BUTTON & CARRIAGE HEAD	6-7754	265.50
HEX & CARRIAGE HEAD	6-7755	270.50
INDENTED HEX & CARRIAGE HEAD	6-7756	270.50
SIX POINT & CARRIAGE	9-9784	460.25

KITS WITH POLISHED BED BOLTS:

BUTTON & CARRIAGE HEAD	6-7754P	400.50
HEX & CARRIAGE HEAD	6-7755P	405.50
INDENTED HEX & CARRIAGE HEAD	6-7756P	420.50
SIX POINT & CARRIAGE - POLISHED	9-9784P	562.75

ACCESSORY KITS (NOT INCLUDED IN THE BODY & BED KITS)

CAB MOUNT KITS - 1/2 TON:	# 6-7467	\$ 57.25
- FOR BLAZER:	6-1346	102.50
- FOR SUBURBAN:	6-1441	112.50

ENGINE FASTENER KITS - SEE PAGES 17-21

ENGINE MOUNTS TO BRACKETS & BRACKETS TO FRAME KIT

SIX POINT -HIGH STRENGTH	6-7725	50.00
TWELVE POINT - HIGH STRENGTH	6-1421	52.50

FRONT BODY MOUNT KITS

-CORE SUPPORT TO FRAME		
CARRIAGE HEAD	6-7743	30.75

REAR END COVER KITS - SEE PAGE 31

TRANSMISSION KITS -SEE PAGE 29

BODY & LONG STEPSIDE BED KITS

BUTTON & SOCKET HEAD	# 6-1862	\$ 490.00
HEX & CARRIAGE HEAD	6-1863	480.50
INDENTED HEX HEAD	6-1864	540.75
ORIGINAL STYLE-INDENTED HEX	6-7434	575.00
WITH BLACK STAINLESS WHERE APPROPRIATE		
SIX POINT - POLISHED	9-9776	1070.00

BODY & SHORT STEPSIDE BED KITS

BUTTON & SOCKET HEAD	6-7726	475.75
HEX & CARRIAGE HEAD	6-1859	465.75
INDENTED HEX HEAD	6-1860	515.75
ORIGINAL STYLE-INDENTED HEX	6-7433	555.50
WITH BLACK STAINLESS WHERE APPROPRIATE		
SIX POINT - POLISHED	9-9778	1038.25

BODY KITS FOR SUBURBANS

BUTTON HEAD	6-1442	410.00
HEX HEAD	6-1443	400.50
INDENTED HEX HEAD	6-1444	435.75
ORIGINAL STYLE - INDENTED HEX	6-1445	460.75
WITH BLACK STAINLESS WHERE APPROPRIATE		

LONG STEPSIDE BED KITS

BUTTON & CARRIAGE HEAD	# 6-1874	\$ 255.00
HEX & CARRIAGE HEAD	6-1875	255.75
INDENTED HEX & CARRIAGE HEAD	6-1876	270.50
SIX POINT & CARRIAGE	9-9782	358.75

KITS WITH POLISHED BED BOLTS:

BUTTON & CARRIAGE HEAD	6-1874P	355.00
HEX & CARRIAGE HEAD	6-1875P	355.75
INDENTED HEX & CARRIAGE HEAD	6-1876P	365.00
SIX POINT & CARRIAGE	9-9782P	473.75

SHORT STEPSIDE BED KITS

BUTTON & CARRIAGE HEAD	6-1870	240.00
HEX & CARRIAGE HEAD	6-1871	245.00
INDENTED HEX & CARRIAGE HEAD	6-1873	250.25
SIX POINT & CARRIAGE	9-9780	327.75

KITS WITH POLISHED BED BOLTS:

BUTTON & CARRIAGE HEAD	6-1870P	325.00
HEX & CARRIAGE HEAD	6-1871P	325.00
INDENTED HEX & CARRIAGE HEAD	6-1873P	330.25
SIX POINT & CARRIAGE	9-9780P	422.50

STEERING BOX MOUNT & COVER KITS

-MANUAL STEERING BOX

SIX POINT -HIGH STRENGTH	6-7752	38.75
--------------------------	--------	-------

-POWER STEERING BOX

SIX POINT -HIGH STRENGTH	6-7753	51.25
TWELVE POINT-HIGH STRENGTH	6-7769	52.25

SUSPENSION KITS - WITH HIGH STRENGTH

U-BOLTS! GREASE FITTINGS & COTTER PINS INCLUDED,

*CASTLE NUTS NOT INCLUDED - SEE PAGE 130**

- FOR 2 WHEEL DRIVE TRUCKS ONLY

FRONT: SIX POINT - 1/2 & 3/4 TON	6-1309	393.75
----------------------------------	--------	--------

TRANSMISSION CROSSMEMBER KIT

SIX POINT -HIGH STRENGTH	6-7739	52.75
TWELVE POINT-HIGH STRENGTH	6-7695	61.00

KITS FOR 1973-1987 CHEVY C/K TRUCKS

BODY KIT- Every Body kit includes component kits for Battery Box, Cowl, Door Hinges, Door Jambs, Interior, Front Bumpers, Front & Inner Fender, Hood Hinges, Hood Latch & Catch, Radiator Support, & Shroud ('81-'87 only), Master Cylinder, Radiator Support, Battery Box, & Hood Latch ('73-'80 only), and Seat Mounts.
 IF YOU NEED FASTENERS FOR A BLAZER OR SUBURBAN (UP TO '91) ORDER A BEDLESS BODY KIT

BEDLESS BODY KITS

1973-1980

BUTTON & FLAT SOCKET HEAD	# 6-1523	\$ 255.00
HEX & PHILLIPS HEAD	6-1524	280.50
INDENTED HEX HEAD	6-1525	315.50
ORIGINAL STYLE-INDENTED HEX	6-1526	350.75

WITH BLACK STAINLESS WHERE APPROPRIATE

1981-1987

BUTTON & FLAT SOCKET HEAD	6-1527	215.75
HEX & PHILLIPS HEAD	6-1528	220.50
INDENTED HEX	6-1529	305.00
ORIGINAL STYLE - INDENTED HEX	6-1530	335.75

WITH BLACK STAINLESS WHERE APPROPRIATE

BODY & FLEETSIDE BED KITS

1973-1980

BUTTON & FLAT SOCKET HEAD	6-7458	380.50
HEX HEAD	6-7459	415.75
INDENTED HEX HEAD	6-7460	480.50
ORIGINAL STYLE-INDENTED HEX	6-7473	515.75

WITH BLACK STAINLESS WHERE APPROPRIATE

1981-1987

BUTTON & FLAT SOCKET HEAD	6-1474	345.50
HEX HEAD	6-1475	355.00
INDENTED HEX HEAD	6-1476	470.50
ORIGINAL STYLE-INDENTED HEX	6-1477	505.75

WITH BLACK STAINLESS WHERE APPROPRIATE

BODY & LONG STEPSIDE BED KITS

1973-1980

BUTTON & SOCKET HEAD	# 6-7454	\$ 465.00
HEX HEAD	6-7455	485.75
INDENTED HEX HEAD	6-7456	540.50
ORIGINAL STYLE-INDENTED HEX	6-7472	575.50

WITH BLACK STAINLESS WHERE APPROPRIATE

1981-1987

BUTTON & SOCKET HEAD	6-1519	425.00
HEX HEAD	6-1520	425.50
ORIGINAL STYLE-INDENTED HEX	6-1521	540.50
ORIGINAL INDENTED HEX	6-1522	560.75

WITH BLACK STAINLESS WHERE APPROPRIATE

BODY & SHORT STEPSIDE BED KITS

1973-1980

BUTTON & SOCKET HEAD	6-7450	445.75
HEX HEAD	6-7451	470.75
INDENTED HEX HEAD	6-7452	540.50
ORIGINAL STYLE-INDENTED HEX	6-7471	575.50

WITH BLACK STAINLESS WHERE APPROPRIATE

1981-1987

BUTTON & SOCKET HEAD	6-1469	415.00
HEX HEAD	6-1470	415.00
INDENTED HEX HEAD	6-1471	530.00
ORIGINAL STYLE-INDENTED HEX	6-1472	560.75

WITH BLACK STAINLESS WHERE APPROPRIATE

**** NOTE INDENTED HEX, & ORIGINAL STYLE BOLTS ARE MADE IN USA ****

BED KIT- Every Complete Bed Kit includes component kits for Bed Mounts, Front Bed Panel, Rear Bumper, Tail Lights, and Tail Gate. Fleetside Bed kits also include kits for: Inner Fender & Fender Braces, and Rear Cross Member. Stepside Bed kits also include kits for; Rear Fenders, Bed Strips, and Side Steps.
 -COMPLETE BED KITS HAVE UNPOLISHED BOLTS UNLESS STATED OTHERWISE-

FLEETSIDE BED KITS

BUTTON & CARRIAGE HEAD	6-7474	\$ 155.00
HEX & CARRIAGE HEAD	6-7475	160.50
INDENTED HEX & CARRIAGE HEAD	6-7476	200.00

KITS WITH POLISHED BED MOUNT BOLTS:

BUTTON & CARRIAGE HEAD	6-7474P	170.00
HEX & CARRIAGE HEAD	6-7475P	170.75
INDENTED HEX & CARRIAGE HEAD	6-7476P	220.25

LONG STEPSIDE BED KITS

BUTTON & CARRIAGE HEAD	6-7488	235.00
HEX & CARRIAGE HEAD	6-7489	230.50
INDENTED HEX & CARRIAGE HEAD	6-7491	255.75

KITS WITH POLISHED BED BOLTS:

BUTTON & CARRIAGE HEAD	6-7488P	335.00
HEX & CARRIAGE HEAD	6-7489P	335.50
INDENTED HEX & CARRIAGE HEAD	6-7491P	360.00

SHORT STEPSIDE BED KITS

BUTTON & CARRIAGE HEAD	# 6-7484	\$ 220.00
HEX & CARRIAGE HEAD	6-7485	220.50
INDENTED HEX & CARRIAGE HEAD	6-7487	255.00

KITS WITH POLISHED BED BOLTS:

BUTTON & CARRIAGE HEAD	6-7484P	310.00
HEX & CARRIAGE HEAD	6-7485P	310.50
INDENTED HEX & CARRIAGE HEAD	6-7487P	345.00

NOTE - ALL BED KITS HAVE 4" LONG CARRIAGE BOLTS IN THE BED MOUNT KIT. SOME TRUCKS USE (2) 12" LONG CARRIAGE BOLTS FOR THE FRONT BED MOUNT, IF YOU NEED THESE ORDER PART #2-0782 - \$13.95 EACH.

-SEE NEXT PAGE FOR ACCESSORY KITS-



ACCESSORY KITS FOR 1973-1987 CHEVY C/K TRUCKS

(NOT INCLUDED IN THE BODY AND BED KITS)

BACKING PLATE BRAKE STUDS - (1) PAIR WITH
SPECIAL NUTS HIGH STRENGTH # 9-7700 \$ 101.25

BRAKE LINES KITS

BUTTON HEAD 6-7764 14.00
INDENTED HEX HEAD 6-7765 20.25

CAB MOUNT KITS

1973-1980
HEX HEAD 6-7748 29.75
SOCKET HEAD 6-7749 37.00
1981-1987
HEX HEAD 6-7750 19.25
SOCKET HEAD 6-7751 26.50

FRONT BODY MOUNT KITS - CORE SUPPORT TO FRAME

1973-1980
HEX HEAD 6-7744 17.00
SOCKET HEAD 6-7745 21.00
1981-1987
HEX HEAD 6-7746 13.00
SOCKET HEAD 6-7747 17.00

DOOR STRIKERS KIT - SOCKET HEAD SHOULDER
BOLTS WITH WASHERS - HIGH STRENGTH 17-4PH -
ELIMINATES PLASTIC SLEEVE 6-7766 95.50

ENGINE FASTENER KITS - SEE PAGES 17-23

ENGINE MOUNTS TO BRACKETS & BRACKETS TO FRAME KIT

SIX POINT -HIGH STRENGTH # 6-7761 \$ 66.75

REAR END COVER KITS -SEE PAGE 31

SHOCK STUD KIT

FRONT - HIGH STRENGTH 9-7701 66.75
REAR - HIGH STRENGTH 9-7702 67.00

STEERING BOX MOUNT & COVER KIT

-MANUAL STEERING BOX
SIX POINT -HIGH STRENGTH 6-7752 38.75
-POWER STEERING BOX
SIX POINT -HIGH STRENGTH 6-7753 51.25
TWELVE POINT -HIGH STRENGTH 6-7769 53.00

SUSPENSION KITS - FOR 1/2 & 3/4 TON TRUCKS
INCLUDES HIGH STRENGTH BOLTS & U-BOLTS!

**CASTLE NUTS NOT INCLUDED - SEE PAGE 130*

FRONT SUSPENSIONS:

2WD: SIX POINT -HIGH STRENGTH 6-7760 593.75

4WD: SIX POINT -HIGH STRENGTH 6-7762 487.25

REAR SUSPENSIONS:

ALL: SIX POINT -HIGH STRENGTH 6-7763 506.00

TRANSMISSION KITS - SEE PAGE 29-30

KITS FOR 1988 -1998 CHEVY TRUCKS

BATTERY BOX KITS

BUTTON HEAD # 6-1535 \$ 6.00
HEX HEAD 6-1536 5.75

BED MOUNT KITS - FLEETSIDE - A4-80

HEX HEAD 6-1541 30.75
SOCKET HEAD 6-1542 36.00

FRONT BODY MOUNT KIT

HEX HEAD 5-5206 25.00
SOCKET HEAD 5-5207 29.00

FRONT & INNER FENDERS KITS

BUTTON HEAD 6-1531 21.50
HEX HEAD 6-1532 18.50

MASTER CYLINDER KIT

HEX NUTS 6-1506 4.00

DOOR STRIKERS KIT - SOCKET HEAD SHOULDER
BOLTS WITH WASHERS 6-8149 65.00

ENGINE FASTENER KITS - SEE PAGES 17-23

TRANSMISSION KITS - SEE PAGE 29-30

HOOD LATCH KITS

BUTTON HEAD # 6-1504 \$ 8.75
HEX HEAD 6-1505 8.25

HOOD HINGES KITS

BUTTON HEAD 6-1501 8.75
HEX HEAD 6-1502 8.50

RADIATOR SUPPORT KITS

BUTTON HEAD 6-1533 10.75
HEX HEAD 6-1534 10.00

TAIL GATE KIT

BUTTON & FLAT SOCKET 6-1510 14.00

REAR END COVER KITS -SEE PAGE 31

SERPENTINE BELT KITS - SEE PAGE 22

T . O . T . A . L . L . Y
STAINLESS

KITS FOR CHEVY S-10 / GMC S-15 & SYCLONE UP THROUGH 1993

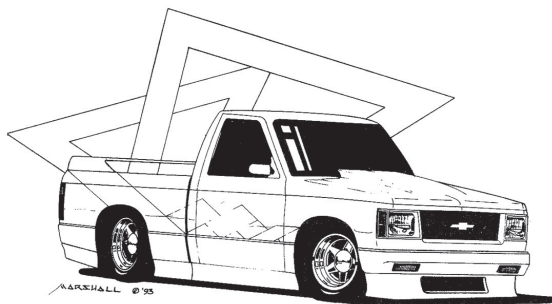

BODY KIT- Every Body kit includes component kits for Battery Box, Bed Mount, Body Mount(Standard Cab), Door Latch, Door Sills, Front & Inner Fenders, Hood Hinges, Hood Latch, Catch & Prop Rod, Heater Blower, Interior, Master Cylinder & Valve, Seat Mount, Radiator Support & Fan Shroud, Rear Fender, Tail Gate Hinge, Latch & Catch, and Windshield Washer Fluid Tank. Kits for Sycloes also include component kits for mounting the Intercooler, Gas Tank and Rear Bumper.

FOR S-10 / GMC S-15:

BUTTON, SOCKET & FLAT SOCKET HEAD	# 5-0731	\$ 225.00
HEX & PHILLIPS HEAD	5-0732	225.00
SOCKET & FLAT SOCKET HEAD	5-0733	260.50

SYCLONE:

BUTTON, SOCKET & FLAT SOCKET HEAD	# 5-2700	\$ 280.75
HEX & PHILLIPS HEAD	5-2702	285.00
SOCKET & FLAT SOCKET HEAD	5-2703	310.50
6 POINT -HIGH STRENGTH - POLISHED	5-2798	907.75

ACCESSORY KITS (NOT INCLUDED IN THE BODY KIT)

ADD ON INTERIOR KITS -FOR EXTENDED CABS

PLAIN FINISH	# 5-0748	\$ 12.00
BLACK FINISH	5-0749	16.50

DOOR STRIKER BOLTS & WASHERS - HIGH STRENGTH 17-4 PH STAINLESS FOR LONGER WEAR - MADE IN USA

SOCKET HEAD (PAIR)	6-8149	65.00
--------------------	--------	-------



CHASSIS KITS - S10/S15: INCLUDES FRONT & REAR SUSPENSION & STEERING BOX

SIX POINT - HIGH STRENGTH		
1982-1993:	# 5-2200	\$ 952.25
1994-2004:	5-2202	1027.75

CHASSIS KITS - SYCLONE: INCLUDES FRONT & REAR SUSPENSION, STEERING BOX, ENGINE MOUNTS, DIFFERENTIAL, DRIVE SHAFTS, BACKING PLATES, AND TRANSMISSION CROSS MEMBER

SIX POINT - HIGH STRENGTH	5-2722	1451.50
---------------------------	--------	---------

ENGINE KITS - SEE PAGE 20-22

REAR COVER KITS - SEE PAGE 31

STEERING BOX MOUNT & COVER KIT

SIX POINT - HIGH STRENGTH	6-8071	58.50
12 POINT - HIGH STRENGTH	6-8075	67.00

TRANSMISSION KITS - SEE PAGE 29-30

BUTTON

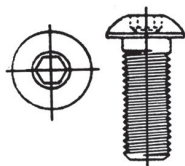

HEX

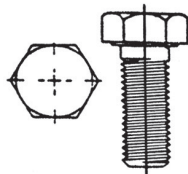

INDENTED HEX (ORIGINAL STYLE)

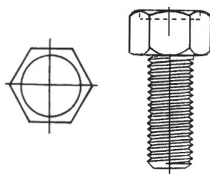

SOCKET

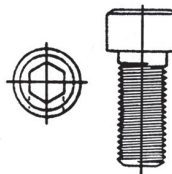

6-POINT

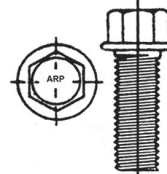

12-POINT

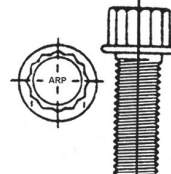

TOLL FREE ORDER LINE : 1-800-767-4781



KITS FOR 1964-1971 LEMANS/GTOS

BODY KIT- Every Body Kit includes component kits for Front Body Mount, Bucket Seats ('68-'71), Bumpers, Door Hinges, Door Jambs, Firewall & Cowl, Front & Inner Fenders, Gas Tank, Gravel Pan('68-'71), Grill, Headlights, & Turn Signals, Hood Hinges, Interior, Radiator/Core Support, & Battery Box, Roll Pan('70-'71), Tail Lights, Trunk Hinges, Latch & Catch, and Windshield Trim & Cowl Vent.

Contains one of each component kit

	1964-1965		1966-1967		1968-1969	
BUTTON AND SOCKET HEAD	# 6-2645	\$ 360.50	# 6-2653	\$ 360.75	# 6-2694	\$ 325.00
HEX HEAD	6-2652	370.75	6-2654	370.75	6-2695	345.00
INDENTED HEX HEAD	6-2603	415.00	6-2655	415.00	6-2696	440.00
ORIGINAL STYLE-INDENTED HEX	6-2604	445.50	6-2656	440.75	6-2697	465.00

WITH BLACK STAINLESS WHERE APPROPRIATE

BUTTON AND SOCKET HEAD

HEX HEAD

INDENTED HEX HEAD

ORIGINAL STYLE-INDENTED HEX

WITH BLACK STAINLESS WHERE APPROPRIATE

1970-1972 GTO

6-2698 \$ 340.75

6-2699 345.00

6-2700 405.00

6-2701 445.50

1970-72 LEMANS

6-2666 \$385.00

6-2667 390.00

6-2660 435.00

6-2668 470.00

** NOTE INDENTED HEX, & ORIGINAL STYLE BOLTS ARE MADE IN USA **

ACCESSORY KITS (NOT INCLUDED IN THE BODY KIT)

CHASSIS KIT - INCLUDES FRONT & REAR SUSPENSION WITH FRONT SWAY BAR, STEERING BOX, ENGINE MOUNTS & TRANSMISSION CROSSMEMBER KITS - HIGH STRENGTH

**CASTLE NUTS NOT INCLUDED - SEE PAGE 130*

1964-1969 - SIX POINT	# 6-8161	\$ 648.75
TWELVE POINT	6-8199	665.50
1970-1972 - SIX POINT	6-8162	667.00
TWELVE POINT	6-2749	696.25
- FOR CARS ORIGINALLY EQUIPPED WITH 4 SPEEDS: HAS (4) LONGER BOLTS FOR THE REAR CONTROL ARMS BRACE		
1964-1969 - SIX POINT	6-8163	649.50
TWELVE POINT	6-2748	674.00
1970-1972 - SIX POINT	6-8164	646.50
TWELVE POINT	6-2744	704.75

ENGINE MOUNTS TO FRAME KITS

SIX POINT -HIGH STRENGTH	6-1945	40.50
TWELVE POINT -HIGH STRENGTH	6-1946	44.25

FRONT & REAR SUSPENSION KITS

HIGH STRENGTH STAINLESS BOLTS, INCLUDING KNURLED BOLTS & TALL NUTS, COMPLETE WITH ZERKS & COTTERS,

**CASTLE NUTS NOT INCLUDED - SEE PAGE 3*

1964-69: SIX POINT	6-8156	521.75
TWELVE POINT	6-8198	523.00
1970-72: SIX POINT	6-8157	499.00
TWELVE POINT	6-2745	513.75
- FOR CARS ORIGINALLY EQUIPPED WITH 4 SPEEDS: HAS (4) LONGER BOLTS FOR THE REAR CONTROL ARMS BRACE		
1964-1969: SIX POINT	6-8167	529.75
TWELVE POINT	6-2746	562.25
1970-1972: SIX POINT	6-8168	526.50
TWELVE POINT	6-2747	558.75

STEERING BOX COVER & MOUNT KITS

SIX POINT - HIGH STRENGTH	6-1936	57.50
TWELVE POINT - HIGH STRENGTH	6-1937	65.75

TRANSMISSION CROSSMEMBER KITS

SIX POINT - HIGH STRENGTH	6-1768	35.25
TWELVE POINT - HIGH STRENGTH	6-1771	37.50

BODY MOUNT KITS - SUPPLEMENT TO FRONT MOUNT:

1964-67: (12 BOLTS & WASHERS)

HEX HEAD	# 6-2647	67.50
SOCKET HEAD	6-2648	92.00
SIX POINT - HIGH STRENGTH	6-2661	150.50
TWELVE POINT - HIGH STRENGTH	6-2662	155.75

1968-72 SEDANS & HARD TOPS: (8 BOLTS & WASHERS)

HEX HEAD	6-2657	48.00
SOCKET HEAD	6-2658	64.00
SIX POINT - HIGH STRENGTH	6-2675	107.75
TWELVE POINT - HIGH STRENGTH	9-2676	111.50

1968-72 CONVERTIBLES & WAGONS: (12 BOLTS & WASHERS)

HEX HEAD	6-2731	70.00
SOCKET HEAD	6-2732	94.00
SIX POINT - HIGH STRENGTH	6-2733	182.00
TWELVE POINT - HIGH STRENGTH	9-2734	185.25

HIDE AWAY HEADLIGHTS KIT

ORIGINAL STYLE	6-2729	15.50
----------------	--------	-------

REAR SHOCK MOUNT STUD KIT - CUSTOM

MADE STUDS WITH NUTS & WASHERS	6-8170	77.00
--------------------------------	--------	-------

REAR SWAY BAR KIT

SIX POINT - HIGH STRENGTH	6-8185	46.25
TWELVE POINT - HIGH STRENGTH	6-8186	48.00

DOOR STRIKERS KIT - SOCKET HEAD SHOULDER

BOLTS WITH WASHERS	6-8154	59.95
--------------------	--------	-------

ENGINE KITS - SEE PAGE 25

REAR COVER KITS - PAGE 31

TRANSMISSION KITS - SEE PAGE 29-30

WHEEL WELL MOULDING KIT

ORIGINAL STYLE - ROUND WASHER HEAD	6-1796	8.00
CUSTOM STYLE - BUTTON HEAD	6-1764	9.00

KITS FOR MODEL A FORDS

Back in 1969, with my brother at the wheel and my cousin in between, on our first Model A - at least part of one. This one was cut down by a previous owner and had a Model T worm drive truck rear installed to make a poor man's tractor. It made a lousy tractor but it was great for pulling wheelies! We paid 15 bucks for it and still have it.



BODY KITS FOR MODEL A'S:

DOES NOT INCLUDE TALL HEX HEAD BOLTS

BED MOUNT KIT

HEX HEAD # 9-2902 \$ 28.00

BED STRIPS KIT - FOR PICK UPS

CARRIAGE HEAD 9-2900 62.00

BODY to CHASSIS KITS - FOR ALL MODEL A's

HEX & CARRIAGE HEAD 9-4104 37.00

DASH KIT

FLAT SOCKET 9-2861 6.50
SLOTTED OVAL HEAD 9-2862 6.75

DOOR HINGES KIT : UNDERSIZED (#12) HEADS COUPES & TWO DOORS: (18 PC)

FLAT SOCKET 9-2884 49.00
SLOTTED FLAT HEAD 9-2885 56.00

ROADSTERS: (16) WITH DIMPLE WASHERS

FLAT SOCKET 9-2886 42.75
SLOTTED FLAT HEAD 9-2887 52.00

DOOR STRIKERS & CATCHES KIT: FOR OPEN CARS (ROADSTERS, (2) KITS NEEDED FOR PHAETONS

FLAT SOCKET 9-2888 7.00
SLOTTED FLAT HEAD 9-2889 7.25

ENGINE KITS FOR MODEL A'S - SEE PG 9

FRONT APRON (SPLASH PAN) KIT

1928-29:

FLAT SOCKET HEAD 9-2863 4.00
SLOTTED OVALHEAD (STOCK STYLE) 9-2864 4.25

1930-31:

BUTTON HEAD 9-2865 4.00
SLOTTED ROUND HEAD (STOCK STYLE) 9-2866 4.25

FRONT BUMPER MOUNT KIT

BUTTON HEAD - WITH LOCK NUTS 9-2855 29.50
HEX HEAD 9-2856 24.75

FRONT FENDERS KIT - FOR BRACES & BOLTS TO SPLASH SHIELDS 1928-29 (WITH FORGED BRACKETS):

BUTTON HEAD - WITH LOCK NUTS # 9-2857 \$ 26.00

HEX HEAD (1/4-20"S HAVE 3/8" WRENCH) 9-2858 30.50

1929 - 31 (WITH STAMPED BRACKETS): INCLUDES THE LONGER BOLTS USED ON LATER 1931'S

BUTTON HEAD - WITH LOCK NUTS 9-2870 23.75

HEX HEAD (1/4-20"S HAVE 3/8" WRENCH) 9-2871 27.50

GAS TANK & COWL KIT

BUTTON HEAD - WITH LOCK NUTS 9-2868 15.75

HEX HEAD (3/8 WRENCH) 9-2869 20.50

HEADLIGHT MOUNT & BULB BRACKET KIT

HEX NUTS & SLOTTED OVAL 9-2860 6.00

HOOD SHELF KIT

BUTTON HEAD - WITH LOCK NUTS 9-2849 7.50

SLOTTED ROUND & 'KEP' NUTS 9-2850 7.75

REAR FENDERS KIT -

CARS WITH FORGED BRACKETS:

BUTTON & SPECIAL CARRIAGE HEAD 9-2872 22.75

HEX & SPECIAL CARRIAGE HEAD 9-2873 23.00

CARS WITH STAMPED BRACKETS:

BUTTON & SPECIAL CARRIAGE HEAD 9-2874 21.75

HEX & SPECIAL CARRIAGE HEAD 9-2875 22.50

RUNNING BOARDS KIT - BOLTS BOARDS TO FENDERS, INCLUDES NUTS & LOCKS FOR BRACKETS:

FLAT TOP CARRIAGE HEAD 9-2867 13.75

WINDSHIELD KIT - FOR 1929-30 OPEN CARS

FLAT SOCKET 9-2897 6.00

SLOTTED OVAL HEAD 9-2898 6.50

KITS FOR 1932 FORD ROADSTERS

BODY KIT- Every Body Kit includes component kits for Body Mounting, Cowl Vent, Door Hinges & Latches, floor board, Gas Tank, Grill & Grill Shell, Hood Hold down & Latch, Interior, Radiator Rod hardware, Trunk Hinges, Latch & Catch, Windshield & Top.

BUTTON HEAD & FLAT SOCKET HEAD
9-4200 \$ 265.00

HEX HEAD & SLOTTED HEAD
(STOCK STYLE) 9-4201 265.00

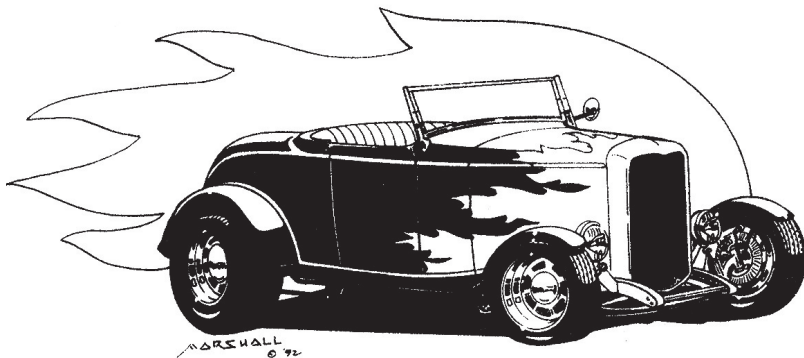

ACCESSORY KITS (NOT INCLUDED IN THE BODY KIT)

AFTER MARKET CHASSIS KITS - PAGES 32-33

SLOTTED 'SEX' SCREWS - FOR COUPE SUN VISORS
SLOTTED OVAL HEAD (PAIR) # 9-4205 \$ 30.75

(6) BOLTS FOR 32 FORD SEDAN SEAT PIVOTS

BUTTON HEAD 6-9402 81.00
HEX HEAD 6-9403 82.00

SLOTTED WINDOW STOP SCREW - FOR 28-40 FORD
WINDOW STOPS (PAIR) 9-4000 23.00

58 KITS FOR 1939 DELUXE THROUGH 1948 FORD



This copper toned beauty belongs to one of the Road Tour members at our open house in June of 2010.

BODY KIT- Each Body Kit includes component kits for Bumpers, Cowl Vent, Door Hinges, Door Jambs, Front & Inner Fenders, Filler Panel & Grill, Glove Box, Headlights, Hood Hinges, Latch & Catch, Hood Trim, Rear Fenders, Running Boards (39-40), Tail Lights, Trunk Hinges, Latch & Catch, Visors, and Window Trim.

	1939 DELUXE & 1940		1941-42*		1946-48	
BUTTON HEAD (pictured above)	# 9-4900	\$ 270.00	9-5005	\$385.75	9-5007	\$ 280.00
HEX HEAD	9-4901	325.00	9-5006	410.00	9-5008	275.00

* HAS RECTANGULAR HEAD BUMPER BOLTS

ACCESSORY KITS (NOT INCLUDED IN THE BODY KIT)

BODY MOUNTING KITS: NOTE A STOCK STYLE HEX KIT IS NOT OFFERED BECAUSE THE BODY MOUNT BOLTS ARE ONLY 5/16 DIAMETER (37-40), 41-48 HAVE (2) THAT ARE 3/8" DIAMETER, THE REST ARE ONLY 5/16).

1937-40: (BOLTS, NUTS & WASHERS) -		
6 POINT - HIGH STRENGTH & CARRIAGE HEAD	# 9-4940	\$ 87.00
12 POINT - HIGH STRENGTH & CARRIAGE HEAD	9-4941	90.00
1941-48: (BOLTS, NUTS & WASHERS)		
SIX POINT - HIGH STRENGTH	9-5002	136.50
TWELVE POINT - HIGH STRENGTH	9-5003	139.50

1939-40 BUMPER BOLTS - SET OF (4) OVAL HEAD CARRIAGE BOLTS NEEDED WHEN THE BUMPERETS AREN'T USED. POLISHED OVAL CARRIAGE HEADS & NUTS 5-9999 73.25

CHASSIS KIT- For 1937-40 chassis using TCI front & rear suspension. Includes component kits for upper & lower control arms, steering rack (except castle nuts - measure height and order as needed), steering box, front & rear sway bars, engine mounts, proportioning valve, leaf springs (including U bolts & tall nuts), grease fittings & cotter pins. Check out the other chassis kits on pages 32-33. SIX POINT - HIGH STRENGTH 9-4999 806.75

ENGINE KITS - SEE PAGE 10

HOOD HINGE SHOULDER BOLTS -

- 17-4 PH HIGH STRENGTH STAINLESS, MADE IN OUR SHOP -

1939-48: WITH STOCK 1/4-28 THREADS		
BUTTON HEAD	# 9-4950	\$ 103.50
HEX HEAD	9-4951	107.00

1939-48: WITH OVERSIDED 5/16-24 THREADS:		
BUTTON HEAD	6-9743	103.50
HEX HEAD	6-9744	107.00

1939-40 TRUNK HINGE SHOULDER BOLTS

BUTTON HEAD	6-9741	44.75
HEX HEAD	6-9742	45.25

DOWEL (GUIDE) PINS - FOR 1941-48

2-8099 \$ 19.50 EACH



CONVERTIBLE TOP KITS (CUSTOM MADE)

PIVOT BOLTS FOR 1933/34 CONVERTIBLE TOP: (6)		
BUTTON HEAD - CUSTOM	# 6-9733	\$141.50
HEX HEAD - ORIGINAL	6-9734	135.25

PIVOT BOLTS FOR 1935/36 CONVERTIBLE TOP: (6)		
BUTTON HEAD - CUSTOM	6-9733	142.50
HEX HEAD - ORIGINAL	6-9734	135.25

RIVET REPLACEMENT KITS FOR 1935/36 FORD TOP:		
BUTTON HEAD - CUSTOM STYLE	6-9404	391.75

1939-40: (102 PC. BOLTS, NUTS & WASHERS)		
BUTTON HEAD - CUSTOM	6-9739	428.75
HEX HEAD - STOCK	6-9740	451.75



1941- EARLY 1942 (3 WINDOW TOP) SHOWN ABOVE		
BUTTON HEAD & LOCK NUTS - CUSTOM - 52 PCS	6-9700	481.25
HEX HEAD, NUTS & SPLITS - ORIGINAL - 70 PCS	6-9701	495.25

LATE 1942 - 1948 (5 WINDOW TOP)		
BUTTON HEAD & LOCK NUTS - CUSTOM - 92 PCS	6-9706	472.75
HEX HEAD, NUTS & SPLITS - ORIGINAL - 112 PCS	6-9707	506.75

ECCENTRIC SHOULDER BOLTS
FOR LATE 1942 THRU 1948 FORDS
AVAILABLE IN THE STOCK HEX HEAD
OR CUSTOM BUTTON HEAD

BUTTON HEAD	2-8064	\$28.00
HEX HEAD	2-8065	\$29.00

(8) ARE INCLUDED IN KITS

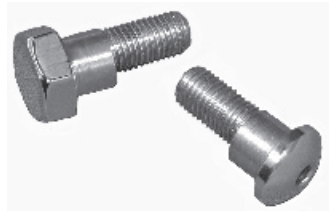

KITS FOR 1949 - 1951 FORD

BODY KIT- Each Body Kit includes component kits for Battery Box, Bumpers, Door Hinges, Door Jambs, Front & Inner Fenders, Firewall, Filler Panel & Grill, Gas Tank Mount Headlights & Turn Signals, Hood Hinges, Horn, Latch & Catch, Hood Trim, Interior, Radiator, Trunk Hinges, Latch & Catch, and Window Trim.

	1949-51 SEDAN		1949-51 HARD TOP
BUTTON & FLAT SOCKET HEAD	# 9-5100	\$ 325.00	# 9-5168 \$ 350.75
HEX & INDENTED HEAD - ORIGINAL STYLE	9-5102	375.00	9-5169 390.50

ACCESSORY KITS (NOT INCLUDED IN THE BODY KIT)

BODY MOUNTING KITS:

1949-51: (BOLTS, NUTS & WASHERS) -		
6 POINT - HIGH STRENGTH	# 9-5162	\$ 99.75
12 POINT - HIGH STRENGTH	9-5163	104.75

ENGINE KITS - SEE PAGE 10

HOOD HINGE SHOULDER BOLTS - 17-4PH

1949-53: HIGH STRENGTH FOR LONG WEAR		
BUTTON HEAD	8-6001	97.50
HEX HEAD (STOCK STYLE)	8-6002	100.25

CONVERTIBLE TOP KITS

1949: (102 PC. BOLTS, NUTS & WASHERS)		
BUTTON HEAD - CUSTOM	# 6-9710	\$ 610.25
HEX HEAD - STOCK	6-9711	638.75
1950: (104 PC. BOLTS, NUTS & WASHERS)		
BUTTON HEAD - CUSTOM	6-9712	610.50
HEX HEAD - STOCK	6-9713	639.00

A BUTTON HEAD KIT FOR A 1950 IS SHOWN BELOW:

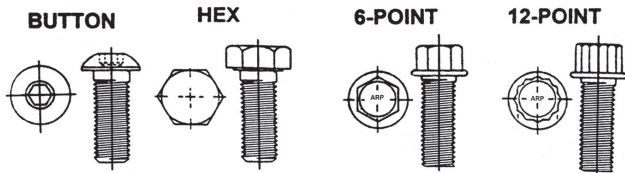

KITS FOR 1955 - 1956 FORD

BODY KIT- Each Body Kit includes component kits for Battery Box, Bumpers, Door Hinges, Door Jambs, Front & Inner Fenders, Firewall, Filler Panel & Grill, Gas Tank Mount Headlights & Turn Signals, Hood Hinges, Horn, Latch & Catch, Hood Trim, Interior, Radiator, Lift Gate / Tail Gate (Station Wagon), Trunk Hinges / Latch & Catch (Sedan) , and Window Trim.

	SEDAN		STATION WAGON
BUTTON & FLAT SOCKET HEAD	# 9-5500	\$ 255.00	# 9-5502 \$ 310.00
HEX & INDENTED HEAD	9-5501	325.75	9-5503 375.00

ACCESSORY KITS (NOT INCLUDED IN THE BODY KIT)

ENGINE KITS - SEE PAGE 11

FRONT SUSPENSION KIT (1954-58)

SIX POINT -HIGH STRENGTH	# 9-5250	\$ 438.00
12 POINT - HIGH STRENGTH	9-5251	451.75

STEERING BOX MOUNT KIT

SIX POINT -HIGH STRENGTH	# 9-5252	\$ 37.50
12 POINT - HIGH STRENGTH	9-5253	38.75

POSIES CUSTOM RANCH WAGON - Now equipped with a super-charged 'Coyote' quad cam modular V8 by Roush - the body and engine are put together with our button head bolts!



Photo Scott Killeen



TOLL FREE ORDER LINE : 1-800-767-4781

KITS FOR 1966-1969 FORD FAIRLANES

Each Body Kit includes component kits for Brake & Fuel Lines, Bumpers, Door Hinges, Door Jambs, Firewall & Cowl, Front & Inner Fenders, Gas Tank, Filler Panel, Grill, Headlights, & Turn Signals, Hood Hinges Latch & Catch, Interior, Radiator/Core Support, & Battery Box, Tail Lights, Trunk Hinges, Latch & Catch (except Ranchero), and Gas Tank Filler. Body kits for Ranchero also include kits for Bed Floor Plate, Tail Gate and Top of Bed trim.



Todd's 1968 Fairlane fastback at the drags.

**** NOTE ORIGINAL STYLE BOLTS ARE MADE IN USA ****

Contains one of each component kit:

- BUTTON HEAD
- INDENTED HEX HEAD
- ORIGINAL STYLE-INDENTED HEX
- WITH BLACK STAINLESS WHERE APPROPRIATE

1966-1967 545 PIECES!		1967 RANCHERO		1968-1969 645 PIECES!	
# 6-9200	\$ 315.00	# 6-9250	\$ 370.25	# 6-9300	\$ 350.75
6-9201	415.75	6-9251	470.50	6-9301	445.50
6-9202	440.50	6-9252	505.75	6-9302	505.00

- ACCESSORY KITS (NOT INCLUDED IN THE BODY KIT) -

ENGINE KITS - SEE PAGES 12-14

TRANSMISSION KITS - SEE PAGES 29-31

STEERING BOX KITS

SIX POINT - HIGH STRENGTH	# 6-4075	\$ 54.75
TWELVE POINT - HIGH STRENGTH	6-4076	57.25

KITS FOR 1955-1963 FORD THUNDERBIRDS

BODY KIT- Includes component kits for Front Body Mount, Front & Rear Bumpers, Door Hinges, Door Jambs, Firewall & Cowl, Front Fender Braces, Filler Panel, Fresh Air Vent, Grill & Splash Pan, Hard Top Hardware, Headlights, Hood Hinges, Inner Fender Splash Pans, Interior, Radiator/Core Support, Seats Mounts, Trunk Hinges, Latch & Catch, and Vent Cable Brackets.

**** NOTE ORIGINAL STYLE BOLTS ARE MADE IN USA ****

Contains one of each component kit - over 700 pieces!

1955-1956 ORIGINAL STYLE-INDENTED HEX WITH BLACK STAINLESS WHERE APPROPRIATE	# 6-8562	\$ 470.75
1957 ORIGINAL STYLE-INDENTED HEX WITH BLACK STAINLESS WHERE APPROPRIATE	6-8572	470.75
1958-1960 ORIGINAL STYLE - INDENTED HEX WITH BLACK STAINLESS WHERE APPROPRIATE	6-8602	570.75
1961-1963 ORIGINAL STYLE - INDENTED HEX WITH BLACK STAINLESS WHERE APPROPRIATE	6-8702	530.25

- ACCESSORY KITS (NOT INCLUDED IN THE BODY KIT) -

ENGINE KITS - SEE PAGES 11 & 14

SOFT TOP KIT FOR 1955-57 - 186 PIECES

HEX & PHILLIPS HEAD # 6-8552 \$ 41.75

BODY MOUNT KIT FOR 1955-57 WITH

"DOG POINT" HEX HEAD BOLTS & STUDS

1955-1957 # 6-8550 \$ 118.75



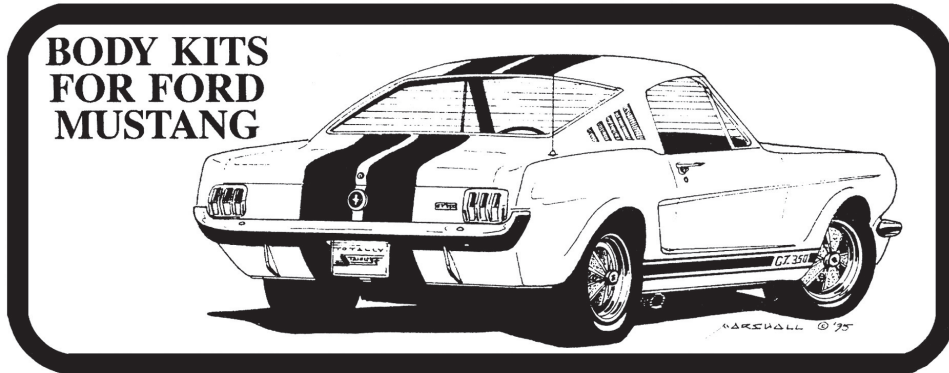

KITS FOR 1964 1/2 - 1970 FORD MUSTANGS

BODY KIT- Every Body Kit includes component kits for Back Up Lights, Battery Box, Bottom of Dash, Bucket Seats, Bumpers, Firewall, Door Hinges, Door Jambs, Emergency Brake Handle & Dash Brace, Front Turn Signals, Front Fender Braces & Front Shocks, Front & Inner Fenders, Grill, Headlight Bucket, Bezel, Gravel Pan & More, Hood Hinges, License Plate, Hood Latch & Catch, Basic Interior, Radiator Support & Horn, Rear Corners, Rear Roll Pan & Bumperettes, Regulator, Starter Relay & Windshield Washer Bag, Tail Lights, and Trunk Hinges, Latch & Catch. Available in 4 different head styles and over 500 pieces in each kit!

Contains one of each component kit

	1964 1/2-1965		1966	
BUTTON & FLAT SOCKET HEAD	# 6-4087	\$ 370.75	# 6-4000	\$ 385.00
HEX & PHILLIPS HEAD	6-4088	390.75	6-4001	390.00
INDENTED HEX HEAD	6-4089	405.00	6-4002	420.00
ORIGINAL STYLE-INDENTED HEX	6-4090	475.00	6-4003	460.00

WITH BLACK STAINLESS WHERE APPROPRIATE

	1967-1968		1969-1970	
BUTTON & FLAT SOCKET HEAD	6-4100	370.75	6-4200	315.00
HEX HEAD	6-4101	390.75	6-4201	330.00
INDENTED HEX HEAD	6-4102	405.75	6-4202	350.00
ORIGINAL STYLE-INDENTED HEX	6-4103	480.00	6-4203	395.00

WITH BLACK STAINLESS WHERE APPROPRIATE

** NOTE INDENTED HEX, & ORIGINAL STYLE BOLTS ARE MADE IN USA **

ACCESSORY KITS (NOT INCLUDED IN THE BODY KIT)

ENGINE KITS - SEE PAGES 10-12

FOLD DOWN REAR SEAT KITS

-1965-1970 FASTBACKS

BUTTON & PHILLIPS HEAD	# 6-4059	\$ 10.00
HEX & PHILLIPS HEAD	6-4060	10.50
INDENTED HEX & PHILLIPS HEAD	6-4061	12.75

FLIP DOWN GAS CAP KIT

PHILLIPS HEAD	6-4142	5.00
---------------	--------	------

ENGINE MOUNTS TO FRAME KITS

-1964 1/2-1970

SIX POINT - HIGH STRENGTH	6-4073	63.50
TWELVE POINT - HIGH STRENGTH	6-4074	67.50

FRONT SUSPENSION KIT: HIGH STRENGTH STAINLESS PLUS GREASE FITTINGS AND COTTER PINS

**CASTLE NUTS NOT INCLUDED - SEE PAGE 130*

SIX POINT - HIGH STRENGTH	6-4091	247.00
---------------------------	--------	--------

GAS TANK MOUNT KIT

INDENTED HEX WASHER HEAD	6-4099	8.25
--------------------------	--------	------

HOOD HINGE RIVET REPLACEMENT KIT

SHOULDERED RIVETS & LOCK NUTS	6-4014	315.00
-------------------------------	--------	--------

OUTER REAR WINDOW TRIM KITS

-1967-1968 (ONLY FOR COUPES)

PHILLIPS HEAD	6-4138	4.25
POLISHED PHILLIPS HEAD	6-4139	8.50

REAR PANEL KITS - FOR FASTBACKS

-1964 1/2-1966

PHILLIPS HEAD	6-4058	10.25
---------------	--------	-------

-1967-1968

PHILLIPS HEAD	6-4140	12.00
POLISHED PHILLIPS HEAD	6-4141	35.00

-1969-1970

PHILLIPS HEAD	6-4241	11.50
---------------	--------	-------

STEERING BOX COVER & MOUNT KITS

-1964 1/2-1970

SIX POINT - HIGH STRENGTH	6-4075	54.75
TWELVE POINT - HIGH STRENGTH	6-4076	57.25

TRANSMISSION KITS - SEE PAGE 29-30

VISORS, REAR VIEW MIRROR AND WINDSHIELD TRIM KITS

-1964 1/2-1966

CONVERTIBLE

POLISHED PHILLIPS	6-4056	22.00
-------------------	--------	-------

COUPE & FASTBACK

PHILLIPS HEAD	6-4057	8.75
---------------	--------	------

-1967-1968: COUPE & FASTBACK

POLISHED PHILLIPS	6-4137	14.00
-------------------	--------	-------

REAR SUSPENSION KITS

-CARS WITH 2 5/16" AXLE TUBES:

SIX POINT - HIGH STRENGTH	6-4093	243.25
---------------------------	--------	--------

-CARS WITH 2 3/4" AXLE TUBES:

SIX POINT - HIGH STRENGTH	6-4094	244.50
---------------------------	--------	--------

-CARS WITH 3" AXLE TUBES

SIX POINT - HIGH STRENGTH	6-4096	245.75
---------------------------	--------	--------

BODY KITS FOR FORD MUSTANG 1978-93

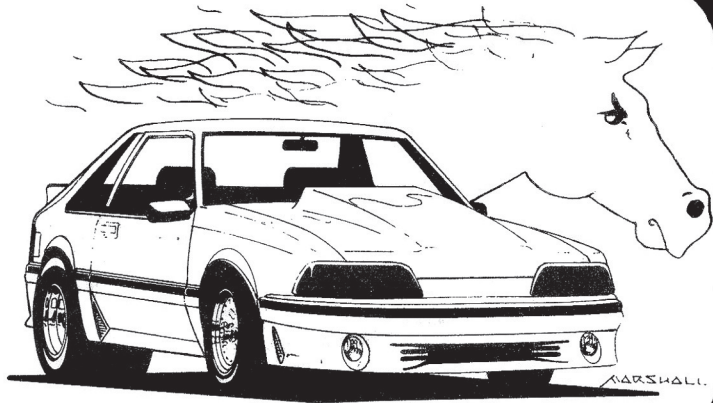

KITS FOR 1978-1993 FORD MUSTANGS

BATTERY BOX KITS

-1973-1983 (U.S. THREAD)		
BUTTON HEAD	# 6-0416	\$ 5.00
HEX HEAD	6-0417	5.50
-1984-1993		
BUTTON HEAD	5-1011	5.25
HEX HEAD	5-1012	5.50

DOOR HINGES

HEX HEAD	6-0429	10.00
INDENTED HEX HEAD	6-0430	16.50
SOCKET HEAD	6-0431	11.00

FRONT/INNER FENDERS KITS

-1978-1984 (U.S. THREAD) - 44 PIECES		
BUTTON HEAD	6-0426	13.50
HEX HEAD	6-0427	15.00
INDENTED HEX HEAD	6-0428	21.50
-1985-1993 (METRIC THREAD) - 52 PIECES		
BUTTON HEAD	5-1017	15.25
HEX HEAD	5-1018	15.50

HOOD HINGE KITS - DOES BOTH

-1978-1981 (1/4" U.S. THREAD)		
BUTTON HEAD	6-0402	7.75
HEX HEAD	6-0401	8.75
INDENTED HEX HEAD	6-0432	11.00
-1982 (5/16" U.S. THREAD)		
BUTTON HEAD	6-0405	6.50
HEX HEAD	6-0406	6.75
-1983-1993 (METRIC THREAD)		
BUTTON HEAD	5-1002	10.50
HEX HEAD	5-1003	10.75

HOOD LATCH & CATCH AND RADIATOR SUPPORT KITS - 44 PIECES

-1978-1983 (U.S. THREAD)		
BUTTON HEAD	# 6-0413	\$ 16.50
HEX HEAD	6-0414	18.75
INDENTED HEX HEAD	6-0433	27.50
-1984-1993 (METRIC THREAD)		
BUTTON HEAD	5-1008	17.25
HEX HEAD	5-1009	17.50

HOOD PROP ROD BRACKET KITS

-1978-1982 (SELF TAPPING)		
HEX HEAD	6-0408	4.00
PHILLIPS HEAD	6-0409	4.25
-1983 (1/4" U.S. THREAD)		
BUTTON HEAD	6-0410	4.00
HEX HEAD	6-0411	4.25
-1984-1993 (METRIC THREAD)		
BUTTON HEAD	5-1005	4.00
HEX HEAD	5-1006	3.25

TRUNK LID/LATCH/LICENSE PLATE KIT

-1978-1983 (U.S. THREAD)		
BUTTON HEAD	6-0421	8.00
HEX HEAD	6-0422	9.00
-1984-1993 (METRIC THREAD)		
BUTTON HEAD	5-1014	7.75
HEX HEAD	5-1015	8.00
-1978-1993 HATCHBACK (U.S. THREAD)		
BUTTON HEAD	6-0424	10.75
HEX HEAD	6-0425	9.00

WINDSHIELD WIPER MOTOR KITS

HEX HEAD	6-0419	4.25
PHILLIPS HEAD	6-0420	4.00

** NOTE INDENTED HEX BOLTS ARE MADE IN USA **

ACCESSORY KITS

ENGINE KITS - SEE PAGE 10

TRANSMISSION KITS - SEE PAGE 29-30

DOOR STRIKERS - 1983-1993

PAIR WITH WASHERS	# 6-0449	\$ 95.50
-------------------	----------	----------

**ACCESSORY BRACKETS KIT FOR 1987-1993
MUSTANGS WITH A 5.0L (302) V8**

INDENTED HEX & HEX HEAD	# 6-0450	\$ 68.00
SOCKET HEAD	6-0451	82.00
SIX POINT - HIGH STRENGTH	6-0452	145.00
TWELVE POINT - HIGH STRENGTH	6-0453	151.00

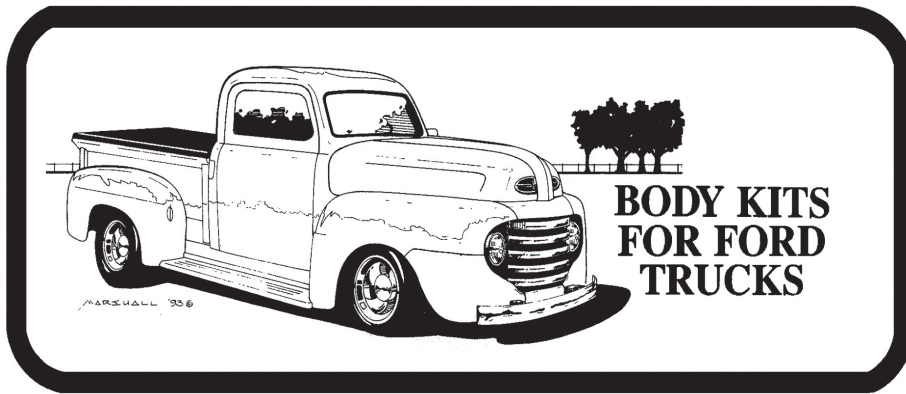

KITS FOR 1940-1947 FORD TRUCKS

BODY KIT- Every Body Kit includes component kits for Door Jambs, Door Hinges, Door Handles, Front Bumper, Front Body Mount (42-47), Grill & Splash Pan, Headlights, Turn Signals, Front Fenders, Radiator, Hood Latch & Catch, Firewall and Interior Kits. Body Kits with a bed also include kits for: Posts, & Tailgate, Rear Fenders, Running Boards, Bed Strips, and Spare Tire Mount Kits.

-IF YOU HAVE A FLATBED OR A PANEL TRUCK ORDER A BEDLESS BODY KIT-

BEDLESS BODY KITS

1940-1941:

BUTTON/SOCKET HEAD	# 9-4700	\$ 225.00
HEX/SLOTTED HEAD	9-4701	240.50

1942-1947:

BUTTON/SOCKET HEAD	6-6800	240.75
HEX/SLOTTED HEAD	6-6802	235.50

1940-47 BED KITS

BUTTON HEAD	6-6827	125.00
HEX HEAD	6-6828	120.50

BODY KITS WITH A STEPSIDE BED

1940-1941:

BUTTON/SOCKET HEAD	# 9-4702	\$ 325.00
HEX/SLOTTED HEAD	9-4703	320.00

1942-1947:

BUTTON/SOCKET HEAD	6-6803	345.75
HEX/SLOTTED HEAD	6-6804	325.00

1942-47 CAB MOUNT KIT

WITH SPRINGS	6-6836	155.00
SPRINGS FOR FRONT MOUNT (2)	6-0311	25.00

KITS FOR 1948-1952 FORD TRUCKS

BODY KIT- Every Body Kit includes component kits for Front Bumper, Cab Mount, Cowl Vent, Door Hinges, Latch & Catch, Door Panel (Interior), Front/Inner Fenders, (48-50) Grill Top & Support, Horn Bracket, Hood, Interior, Radiator Support & Braces, Seat Mounts, Steering Column Clamp Bolt, and Transmission Cover.

Body Kits with Beds also include kits for; Bed Strip & Side Angles, Front Bed Panel, Running Boards & Brackets, Rear Bumper, Rear Fender, Tailgate, and Tail Lights & License Plate kits.

-IF YOU HAVE A FLATBED OR A PANEL TRUCK ORDER A BEDLESS BODY KIT-

BEDLESS BODY KITS - 782 PIECES!

-1948-1950:

BUTTON/SOCKET HEAD	# 6-0362	\$ 270.50
HEX/PHILLIPS HEAD	6-0363	265.50

-1951-1952:

BUTTON/SOCKET HEAD	6-0364	260.00
HEX/PHILLIPS HEAD	6-0365	255.00

BODY KITS WITH A BED - 1172 PIECES!

-1948-1950:

BUTTON/SOCKET HEAD	# 6-0301	\$ 415.00
HEX/PHILLIPS HEAD	6-0302	415.50

-1951-1952:

BUTTON/SOCKET HEAD	6-0359	410.00
HEX/PHILLIPS HEAD	6-0357	400.00

ACCESSORY KITS (NOT INCLUDED IN THE BODY KIT)

CLUTCH COVER (DUST COVER) KITS

HEX HEAD	# 6-0360	\$ 13.00
INDENTED HEX HEAD	6-0355	18.75

BED MOUNT KIT - HEX/FLAT SOCKET

UNPOLISHED	6-0305	45.75
POLISHED	6-0316	59.50

3 SPEED TRANSMISSION KIT

TAILSHAFT HOUSING, SIDE COVER, SHIFT AND SPEEDOMETER CABLE

HEX HEAD	# 6-0354	\$ 18.50
----------	----------	----------

SPRINGS FOR RADIATOR MOUNT (2)	6-0311	25.00
---------------------------------------	--------	-------

(1942-52)



REAR FENDER BOLTS FOR 1948-79 STEPSIDE FORD TRUCKS!

- MADE FOR AFTERMARKET BEDSIDES WITH SQUARE HOLES. SPECIAL FLAT HEAD WITH SHORT HEIGHT SQUARE.

5/16-24 x 11/16 (WITH SQUARE) # 2-0773 \$ 2.99

PACK OF 24 BOLTS 6-0312 \$26.00

24 BOLTS/NUTS/FLAT & LOCK WASHERS 6-0314 \$40.50

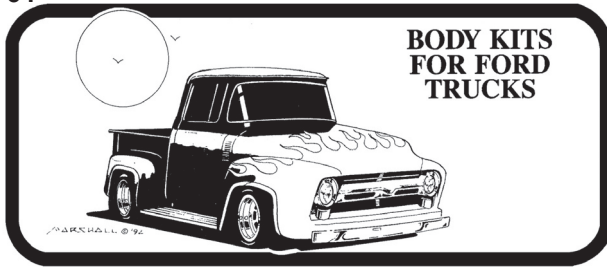

KITS FOR 1953-1956 FORD TRUCKS

BODY KIT- Every Body Kit includes component kits for Battery Box, Front Bumper, Cowl Vent, Door Hinges, Door Jambs, Firewall, Fresh Air Vent, Front Fender Brace Rod, Front/Inner Fenders, Hood Brace, Hood Hinges, Hood Latch, Interior, Radiator Support, Seat Mounts, and Splash Guards/Gravel Pan. Stepside Body Kits include the Bedless kit plus: Bed Strip & Side Angles, Front Bed Panel, Running Boards & Brackets, Rear Bumper, Rear Fender (nuts & washers only), Tailgate, and Tail Lights & License Plate kits.
-IF YOU HAVE A FLATBED TRUCK ORDER A BEDLESS BODY KIT-

Contains one of each component kit

** NOTE ORIGINAL STYLE INDENTED HEX BOLTS ARE MADE IN USA **

BEDLESS BODY KITS - 780 PIECES!

BUTTON/SOCKET HEAD	# 6-0271	\$ 260.75
HEX HEAD	6-0272	250.00
INDENTED HEX HEAD	6-0293	290.50
SIX POINT - POLISHED	6-0270	640.50

STEPSIDE BODY KITS - 1198 PIECES!

BUTTON/FLAT SOCKET HEAD	# 6-0246	\$ 415.00
HEX HEAD	6-0255	375.00
INDENTED HEX HEAD	6-0294	430.75
SIX POINT - POLISHED	6-0298	970.25

PANEL TRUCK BODY KITS - 998 PIECES!

BUTTON/FLAT SOCKET HEAD	# 6-0200	\$ 285.00
HEX HEAD	6-0221	285.00
INDENTED HEX HEAD	6-0230	320.00

ACCESSORY KITS (NOT INCLUDED IN THE BODY KIT)

BED MOUNT BOLT KIT

BUTTON/FLAT SOCKET	# 6-0309	41.00
SLTD FLAT/SLTD ROUND	6-0310	31.00

CAB MOUNT BOLT KIT

HEX HEAD	6-0275	41.00
SOCKET HEAD	6-0276	38.00
SIX POINT - HIGH STRENGTH	6-0274	107.50

MASTER CYLINDER MOUNT KIT

HEX HEAD	6-0356	6.50
----------	--------	------

ENGINE KITS - SEE PAGES 10-11

3 SPEED TRANSMISSION KIT -SIDE COVER, SHIFT LEVERS, SPEEDO, CABLE & TAILSHAFT HOUSING

HEX HEAD	# 6-0354	\$ 18.50
----------	----------	----------

CLUTCH COVER (DUST COVER) KIT

HEX HEAD	6-0360	13.00
INDENTED HEX HEAD	6-0355	18.75
SIX POINT - HIGH STRENGTH	6-0374	60.50

FRONT BODY MOUNT KIT

SIX POINT - HIGH STRENGTH	6-0273	22.50
---------------------------	--------	-------

HOOD HINGE SHOULDER BOLTS - SET OF (4)

DRILLED - 17-4 PH	BUTTON HEAD	6-0201	113.00
HIGH STRENGTH	HEX HEAD	6-0202	114.25

KITS FOR 1957-1960 FORD TRUCKS

BODY KIT - Every Body kit includes component kits for Front Bumper, Cowl Vent, Door Hinge, Jambs, Latch & Catch, Firewall, Front Fender, Headlight Bezel & Front Turn Signals, Hood Hinge, Latch & Catch, Interior Trim Screw, Inner Fender, Radiator Support & Horn, Seat Mounting, and Transmission Cover. Body Kits with Beds also include all appropriate bed component kits listed on the next page under bed kits.

-IF YOU HAVE A FLATBED OR A PANEL TRUCK ORDER A BEDLESS BODY KIT-

Contains one of each component kit

BEDLESS BODY KITS

BUTTON/SOCKET HEAD	# 6-0003	\$ 255.00
HEX HEAD	6-0007	240.75
INDENTED HEX HEAD	6-6264	255.00

BODY KITS WITH A STYLESIDE BED

BUTTON/SOCKET HEAD	6-0049	315.00
HEX HEAD	6-0050	300.75
INDENTED HEX HEAD	6-6266	330.00

BODY KITS WITH A STEPSIDE BED

BUTTON/SOCKET HEAD	# 6-0045	\$ 395.00
HEX HEAD	6-0046	385.00
INDENTED HEX HEAD	6-6265	400.00

** NOTE ORIGINAL STYLE INDENTED HEX BOLTS ARE MADE IN USA **

ACCESSORY KITS (NOT INCLUDED IN THE BODY KIT)

CAB MOUNT BOLT KIT

HEX HEAD	6-0051	32.00
----------	--------	-------

FRONT BODY MOUNT KIT

HEX HEAD	6-6025	12.00
----------	--------	-------

STEERING BOX MOUNT & COVER KIT

SIX POINT - HIGH STRENGTH	6-0023	52.75
---------------------------	--------	-------

ENGINE KITS - SEE PAGES 11-14

BED KITS FOR 1957-1960 TRUCKS: - Bed Kits include component kits for Bed Mounts, Tailgate, and Tail Lights. Stepside Bed kits also include: Bed Strip & Side Angles, Rear Bumper & License Plate, Front Bed Panel, Rear Fenders, and Side Steps.

Contains one of each component kit

STYLESIDE BED KITS

BUTTON/HEX HEAD	# 6-0052	\$ 85.00
HEX HEAD	6-0053	85.50

STEPSIDE BED KITS

BUTTON/NYLON LOCKING NUTS	#6-0268	\$165.00
HEX/HEX NUTS	6-0269	170.00

BODY KITS FOR FORD TRUCKS

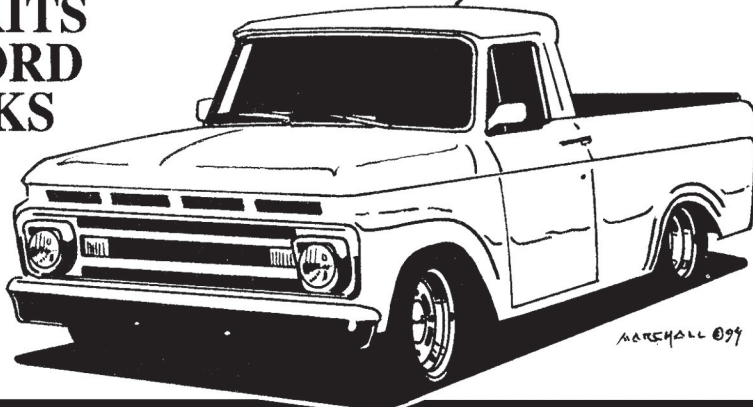

BODY KITS FOR 1961-1966 FORD TRUCKS

BODY KIT- Every Body Kit includes component kits for Bumper(front bumper & brackets with polished carriage), Door Hinges, Door Jamb, Latch & Catch(does both), Firewall, Front Fender (does both), Headlight Bezel & Front Turn Signals, Hood Hinges(does both), Hood Latch & Catch, Interior Door Panel, Interior Trim Screws, Inner Fender, Radiator Support, Front Panel & Horn, Seat Mounting, Starter & Horn Relays, Regulator & Wiring Harness, and Splash Guards(for panels that mount to bottom front corners of frame).

Body Kits with Beds also include all appropriate bed component kits listed on the next page under bed kits.

-IF YOU HAVE A FLATBED OR A PANEL TRUCK ORDER A BEDLESS BODY KIT-

BEDLESS BODY KITS

1961-1964:

BUTTON HEAD	# 6-6016	\$ 250.50
HEX HEAD	6-6017	255.75
INDENTED HEX HEAD	6-6270	265.50

1965-1966:

BUTTON HEAD	6-6289	215.50
HEX HEAD	6-6290	235.00
INDENTED HEX HEAD	6-6291	250.75

BODY KITS WITH A STEPSIDE BED

1961-1964:

BUTTON HEAD	6-6061	380.00
HEX HEAD	6-6062	385.50
INDENTED HEX HEAD	6-6271	400.00

1965-1966:

BUTTON HEAD	6-6091	350.50
HEX HEAD	6-6292	365.00
INDENTED HEX HEAD	6-6293	380.00

BODY KITS WITH A STYLESIDE BED

1961-1964:

BUTTON HEAD	# 6-6064	\$ 345.75
HEX HEAD	6-6065	350.25
INDENTED HEX HEAD	6-6272	365.00

1965-1966:

BUTTON HEAD	6-6294	315.00
HEX HEAD	6-6295	325.00
INDENTED HEX HEAD	6-6296	345.00

BODY KITS - 61-64 WITH A 1957-60 STYLESIDE BED

BUTTON HEAD	6-6070	335.00
HEX HEAD	6-6071	310.50
INDENTED HEX HEAD	6-6273	350.00

BODY KITS WITH A UNIBODY BED - 1961-63

BUTTON HEAD	6-6067	370.00
HEX HEAD	6-6068	360.50
INDENTED HEX HEAD	6-6274	390.00

** NOTE ORIGINAL STYLE INDENTED HEX BOLTS ARE MADE IN USA **

ACCESSORY KITS (NOT INCLUDED IN THE BODY KIT)

CAB MOUNT KITS

1961-1964:

HEX HEAD	# 6-6053	\$ 38.00
----------	----------	----------

1965-1972:

HEX HEAD	6-6045	41.50
----------	--------	-------

ENGINE KITS - SEE PAGES 11-14

FRONT BODY MOUNT KITS

1961-1964:

HEX HEAD	# 6-6025	\$ 12.00
----------	----------	----------

1965-1972:

HEX HEAD	6-6095	15.00
SOCKET HEAD	6-6096	20.00

FRONT SUSPENSION KITS - 2WD TRUCK

1965-1966:

SIX POINT - HIGH STRENGTH	6-6300	296.25
---------------------------	--------	--------

REAR SUSPENSION KITS- INCLUDES U-BOLTS!

1965-66:

SIX POINT - HIGH STRENGTH	6-6301	436.50
---------------------------	--------	--------

BED KITS FOR 1961-66 FORD TRUCKS

BED KIT - Every **Styleside** Bed Kit includes component kits for Bed Mount, Tailgate and Tail Lights. **Stepside** Bed Kits include Bed Strip & Side Angles, Rear Bumper, Front Bed Panel, Side Steps, Rear Fenders(Does Both; does NOT contain weld studs or flat top carriage bolts for stepside), Tailgate, License Plate & Tail Light. ** NOTE ORIGINAL STYLE INDENTED HEX BOLTS ARE MADE IN USA **

STEPSIDE BED KITS - 437 PIECES!

BUTTON HEAD	# 6-0268	\$ 165.00
HEX HEAD	6-0269	170.50

UNIBODY BED KITS

BUTTON HEAD	6-6074	145.00
HEX HEAD	6-6075	145.00
INDENTED HEX HEAD	6-6285	160.25

STYLESIDE BED KITS - 1957-60

BUTTON HEAD	6-0052	85.00
HEX HEAD	6-0053	85.50

STYLESIDE BED KITS - 1961-1964:

BUTTON HEAD	# 6-6072	\$ 120.75
HEX HEAD	6-6073	120.00
INDENTED HEX HEAD	6-6286	130.50

STYLESIDE BED KITS - 1965-1966:

BUTTON HEAD	6-6297	120.25
HEX HEAD	6-6298	120.50
INDENTED HEX HEAD	6-6299	130.00

** NOTE ORIGINAL STYLE INDENTED HEX BOLTS ARE MADE IN USA **

ACCESSORY KITS

(NOT INCLUDED IN THE BODY KIT)

STEPSIDE BED MOUNT BOLT - USES 3/8"

BOLTS WITH ORIGINAL STYLE FLANGED CUP WASHERS

BUTTON/FLAT SOCKET/HEX	6-0309	41.75
------------------------	--------	-------

STYLESIDE REAR BUMPER KITS

-USES 1/2" POLISHED CARRIAGE BOLTS

BUTTON HEAD	6-6058	32.00
HEX HEAD	6-6057	31.00

BODY KITS FOR 1967-1972 FORD TRUCKS

BODY KIT - Every Body kit includes component kits for Battery Box, Windshield Washer Tank, & Relay, Front Bumper(polished Carriage), Door Hinge, Jambs, Latch & Catch, Front & Inner Fenders, Hood Hinges, Latch & Catch, Interior, Master Cylinder & Steering Column, Radiator Support & Horn, and Seat Mounting.

Body Kits with Beds also include all appropriate bed component kits listed below under bed kits.

-IF YOU HAVE A FLATBED OR A PANEL TRUCK ORDER A BEDLESS BODY KIT-

BEDLESS BODY KITS

BUTTON HEAD	# 6-6143	\$ 225.75
HEX HEAD	6-6144	225.00
INDENTED HEX HEAD	6-6146	245.75
ORIGINAL STYLE-INDENTED HEX	6-6168	290.00

WITH BLACK STAINLESS WHERE APPROPRIATE

BODY KITS WITH STYLESIDE BEDS

BUTTON HEAD	# 6-6150	\$ 280.75
HEX HEAD	6-6151	285.00
INDENTED HEX HEAD	6-6152	315.50
ORIGINAL STYLE-INDENTED HEX	6-6161	355.50

WITH BLACK STAINLESS WHERE APPROPRIATE

BODY KITS WITH STEPSIDE BEDS

BUTTON HEAD	6-6154	315.00
HEX HEAD	6-6155	320.00

INDENTED HEX HEAD	6-6156	335.00
ORIGINAL STYLE - INDENTED HEX	6-6169	375.00

** NOTE INDENTED HEX, & ORIGINAL STYLE BOLTS ARE MADE IN USA **

DOOR STRIKER BOLTS - SEE PAGE 5

ACCESSORY KITS (NOT INCLUDED IN THE BODY KIT)

CAB MOUNT KIT

HEX HEAD	6-6045	41.50
----------	--------	-------

FOLD BACK MIRRORS KIT - DOES BOTH

ORIGINAL STYLE	6-0163	36.50
----------------	--------	-------

FRONT BODY MOUNT KITS

HEX HEAD	6-6095	15.00
SOCKET HEAD	6-6096	20.00

FRONT SUSPENSION KIT - 2WD TRUCKS

SIX POINT - HIGH STRENGTH	6-6300	296.25
---------------------------	--------	--------

REAR SUSPENSION KIT - INCLUDES U-BOLTS!

SIX POINT - HIGH STRENGTH	6-6301	436.50
---------------------------	--------	--------

STEERING BOX COVER & MOUNT KIT

SIX POINT - HIGH STRENGTH	6-6135	53.00
---------------------------	--------	-------

ENGINE KITS - SEE PAGES 12-14

BED KIT - Every **Styleside** Bed Kit includes component kits for Bed Mount, Tailgate and Tail Lights.

Stepside Bed Kits include Bed Strip & Side Angles, Rear Bumper, Front Bed Panel, Side Steps, Rear Fenders(Does Both; does NOT contain weld studs or flat top carriage bolts for stepside), Tailgate, License Plate & Tail Light. ** NOTE ORIGINAL STYLE INDENTED HEX BOLTS ARE MADE IN USA **

STYLESIDE BED KITS

BUTTON HEAD	6-6158	85.50
HEX HEAD	6-6159	85.00
INDENTED HEX HEAD	6-6160	95.75

SHORT STEPSIDE BED KITS - 437 PIECES!

BUTTON HEAD	6-0268	165.00
HEX HEAD	6-0269	170.00

** NOTE ORIGINAL STYLE INDENTED HEX BOLTS ARE MADE IN USA **

ACCESSORY KITS (NOT INCLUDED IN THE BODY KIT)

STEPSIDE BED MOUNT KIT - USES 3/8" BOLTS WITH ORIGINAL STYLE FLANGED CUP WASHERS

BUTTON/FLAT SOCKET HEAD	6-0309	41.75
-------------------------	--------	-------

BODY KITS FOR 1973-1979 FORD TRUCKS

BODY KIT - Body kits include component kits for Battery Box, Starter Solenoid, & Relay, Front Body Mount, Front Bumper(polished Carriage), Door Hinge, Jambs, Latch & Catch, Front & Inner Fender(does both), Hood Hinges, Latch & Catch, Interior, Jack Mount, Master Cylinder, Radiator Support & Grill, and Seat(for bench seats). Body Kits with Beds also include all appropriate bed component kits listed below.

BEDLESS BODY KITS

1973-1977:

BUTTON HEAD	# 6-6236	\$ 240.50
HEX HEAD	6-6237	240.50
INDENTED HEX HEAD	6-6238	255.75

1978-1979:

BUTTON HEAD	6-6239	235.75
HEX HEAD	6-6240	240.75
INDENTED HEX HEAD	6-6241	255.25

BODY KITS FOR 1978-79 BRONCO:

BUTTON HEAD	6-6254	345.00
HEX HEAD	6-6255	350.25
INDENTED HEX HEAD	6-6256	365.50

BODY KITS WITH A STEPSIDE BED

1973-1977:

BUTTON HEAD	6-6222	380.00
HEX HEAD	6-6223	385.00
INDENTED HEX HEAD	6-6224	415.75

ACCESSORY KITS (NOT INCLUDED IN THE BODY KIT)

CAB MOUNT KIT

HEX HEAD	6-0172	25.75
----------	--------	-------

TAILGATE CABLE BOLTS

SET OF 4 WITH WASHERS	6-6259	106.75
-----------------------	--------	--------

DOOR STRIKER BOLTS - 1 PAIR

WITH WASHERS	6-6217	95.50
--------------	--------	-------

BED KIT - Every **Styleside** Bed Kit includes component kits for Bed Mount, Tailgate, Rear Side Markers & Tail Lights & License Plate. **Stepside** Bed Kits include Bed Strip & Side Angles, Rear Bumper, Front Bed Panel, Side Steps, Rear Fenders(Does Both; does NOT contain weld studs or flat top carriage bolts for stepside), Tailgate, License Plate & Tail Light. ** NOTE ORIGINAL STYLE INDENTED HEX BOLTS ARE MADE IN USA **

STYLESIDE BED KITS

BUTTON/CARRIAGE	6-6230	90.00
HEX/CARRIAGE	6-6231	85.00
INDENTED HEX/CARRIAGE	6-6232	105.00

BODY KITS WITH A STEPSIDE BED

1978:

BUTTON HEAD	# 6-6235	\$ 370.50
HEX HEAD	6-6233	385.75
INDENTED HEX HEAD	6-6234	395.75

BODY KITS WITH A STYLESIDE BED

1973-1977:

BUTTON HEAD	6-6214	310.50
HEX HEAD	6-6215	315.00
INDENTED HEX HEAD	6-6216	330.50

1978-1979:

BUTTON HEAD	6-6218	300.75
HEX HEAD	6-6219	310.50
INDENTED HEX HEAD	6-6220	325.00

** NOTE ORIGINAL STYLE INDENTED HEX BOLTS ARE MADE IN USA **

ENGINE KITS - SEE PAGES 12-14

FOLD BACK MIRROR KIT - DOES BOTH

ORIGINAL STYLE	6-0163	36.50
----------------	--------	-------

TAILGATE STRIKER BOLTS

SET OF 2 WITH WASHERS	6-6257	42.00
-----------------------	--------	-------

STEPSIDE BED KITS - 1973-1979

BUTTON HEAD	6-0268	165.00
HEX HEAD	6-0269	170.00

BODY KITS FOR 1980-1991 FORD TRUCKS

BODY KIT - Body kits include component kits for Battery Box, Starter Solenoid, & Relay, Bed Mount, Front Body Mount, Front Bumper(polished Carriage), Cowl Cover, Door Hinge, Door Jambs, Front & Inner Fender(does both), Gas Pedal, Grill, Hood Hinges, Hood Latch, Interior, Master Cylinder, Radiator Support, and Seat(for bench seats). Body Kits with Styleside Beds also include component kits for Bed Mounts, Tailgate, and Tail Lights.

-IF YOU HAVE A FLATBED OR A PANEL TRUCK ORDER A BEDLESS BODY KIT-

BEDLESS BODY KITS

1980-1986:

BUTTON HEAD	6-2330	215.75
HEX HEAD	6-2331	190.50

1987-1991:

BUTTON HEAD	6-2367	245.25
HEX HEAD	6-2368	225.00

BODY KITS WITH A STYLESIDE BED

1980-1984:

BUTTON HEAD	6-2374	325.50
HEX HEAD	6-2375	310.50

1985-1986:

BUTTON HEAD	6-2376	315.75
HEX HEAD	6-2377	310.00

1987-1991:

BUTTON HEAD	6-2369	345.75
HEX HEAD	6-2370	320.75

ACCESSORY KITS (NOT INCLUDED IN THE BODY KIT)

WINDOW TRIM FOR BRONCO/CLUB CAR EXTRA

ORIGINAL STYLE	6-2361	19.00
----------------	--------	-------

CENTER CONSOLE KIT FOR BRONCO

ORIGINAL STYLE	6-2362	9.00
----------------	--------	------

CAB MOUNT KIT - HEX HEAD

6-2366	28.75
--------	-------

ENGINE KITS - SEE PAGES 12-14

TAILGATE FOR BRONCO

BUTTON HEAD	6-2365	26.00
HEX HEAD	6-2363	26.50
INDENTED HEX HEAD	6-2364	28.75

BED MOUNT KIT - INCLUDES SPECIAL CARRIAGE HEAD SHOULDER BOLTS

CARRIAGE HEAD	6-2360	139.50
---------------	--------	--------

KITS FOR 1966-1977 FORD BRONCOS

BODY KIT- includes component kits for Battery Box & Horn, Bumpers, Cowl Vent, Door Hinges, Jamb, Latch & Catch, Door Straps, Front Fenders, Heater to Firewall, Hood Hinges, Latch & Catch, Inner Door Panel, Interior, Lenses, Master Cylinder, Radiator Support, Rear Axle Bump Stops, Starter Solenoid & Relay, Front Seats, Steering Column Mount & Bezel, Washer Tank, Tailgate, and Windshield Retaining Bolts.

Contains one of each component kit

BUTTON HEAD	# 6-6500	\$ 230.25
HEX HEAD	6-6501	245.75
ORIGINAL STYLE - INDENTED HEX HEAD	6-6502	285.50

** NOTE INDENTED HEX BOLTS ARE MADE IN USA **

ACCESSORY KITS (NOT INCLUDED IN THE BODY KIT)

BODY(CAB) MOUNT KIT

HEX HEAD # 6-6546 \$ 38.75

FRONT BODY MOUNT KIT

HEX HEAD 6-6560 16.75

REAR LIFT GATE KITS

BUTTON/FLAT SOCKET HEAD 6-6553 32.00
PHILLIPS HEAD 6-6554 18.25

REAR SEAT BOLT KITS

BUTTON HEAD 6-6548 10.50
HEX HEAD 6-6549 11.00
INDENTED HEX HEAD 6-6547 13.25

STEERING BOX MOUNT KIT

SIX POINT 6-6566 54.50

TOP TO BODY BOLT KITS

BUTTON HEAD # 6-6557 \$ 34.00
HEX HEAD 6-6558 35.75
INDENTED HEX HEAD 6-6559 47.00

REAR SUSPENSION KIT - INCLUDES HIGH

STRENGTH BOLTS & U-BOLTS!

1966-1975: SIX POINT 6-6565 422.75
1976-1977: SIX POINT 6-6567 425.75

SPARE TIRE CARRIER KIT

BUTTON HEAD 6-6570 10.50
HEX HEAD 6-6571 11.00
INDENTED HEX HEAD 6-6572 14.50

- SEE PAGE 67 FOR 1978-79 FORD BRONCO KITS -

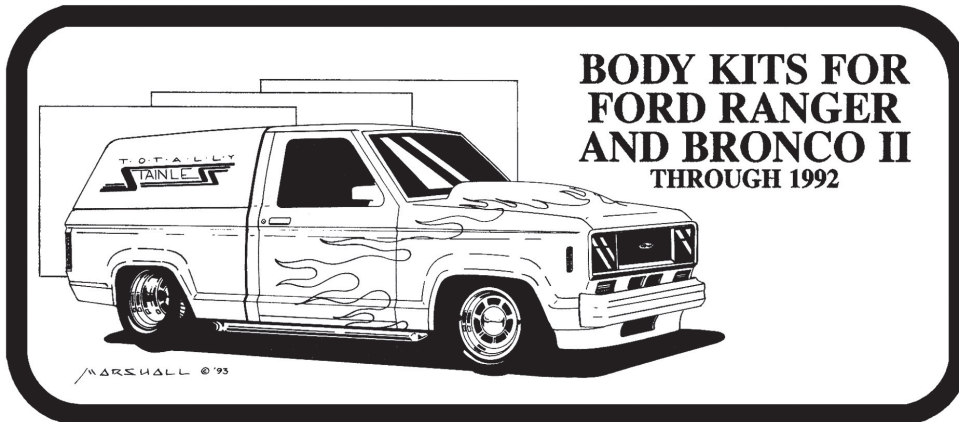

DOOR HINGES KITS - DOES BOTH!

BUTTON HEAD # 5-0309 \$ 15.00
HEX HEAD 5-0310 15.50

DOOR SILL PLATE KIT - DOES BOTH

PHILLIPS HEAD 5-0312 4.00

FRONT BUMPER KITS

1982-1989:

BUTTON HEAD 5-0321 16.50
HEX HEAD 5-0322 15.50

1990-1992:

BUTTON HEAD 5-0323 45.00
HEX HEAD 5-0324 36.75

FRONT/INNER FENDERS KITS

BUTTON HEAD 5-0318 13.75
HEX HEAD 5-0319 14.00

HEADLIGHTS/GRILL & SIGNALS KITS

1982-1989:

PHILLIPS HEAD 5-0325 8.25

1990-1992:

BUTTON/PHILLIPS HEAD 5-0326 21.00
HEX/PHILLIPS HEAD 5-0327 21.50

HOOD LATCH & CATCH KITS

BUTTON HEAD # 5-0300 \$ 5.75
HEX HEAD 5-0301 5.75

HOOD HINGE KITS - DOES BOTH!

BUTTON HEAD 5-0303 5.25
HEX HEAD 5-0304 5.25

RADIATOR SUPPORT KITS

BUTTON HEAD 5-0315 6.75
HEX HEAD 5-0316 6.75

REAR GLASS KIT FOR BRONCO II

BUTTON/PHILLIPS HEAD 5-0328 5.75
HEX/PHILLIPS 5-0329 5.75

SPARE TIRE CARRIER MOUNT KITS

BUTTON HEAD 5-0320 14.00
SOCKET HEAD 5-0317 15.00

TAILGATE KITS

-FLAT SOCKET USED ON HINGE MOUNTS

BUTTON HEAD 5-0313 11.50
HEX HEAD 5-0314 11.25

TOLL FREE ORDER LINE : 1-800-767-4781

BODY & SUSPENSION KITS FOR CJ5, CJ6, CJ7, CJ8 & WRANGLER



BODY KIT - Body Bolt kits include one of each component kit, including: Antenna Mount (73-86), Back Cab Panel (CJ8), Battery Box/Firewall, Body Mount (including big body mount washers!), Front Bumper, Cowl Vent (1972-86 CJ's, Dash, Door Handles, Window Cranks, Door Latches, Strikers, Limiter Strap Bracket(Hardtop & Wrangler), Interior Door Handles (CJ Hardtops), Fenders (does both), Fender Flares (1976-86 CJ's & Wrangler), Front Seat Mounts, Fuel Filler (1976-86 CJ's & Wrangler), Gas Pedal & Steering Column (1976-86 CJ's & Wrangler), Glove Box (55-71), Hard Top Fastener (CJ7, Scrambler, Wrangler), Headlight/Turn Signals, Under Hood Brace Rods, Hood Hinges, Hood Hold Down, Hood Latch & Support Rod, Horn, Overflow Tank & Washer Tank (1972-86 CJ's & Wrangler, includes Jack mount), Jack Bracket (1976-86 CJs), Master Cylinder & Hydraulic Clutch Cylinder (1972-1986 CJs), Mirrors (does 2 door mirrors; all but 87-93 full steel doors on Wrangler), Radiator Mount, Rear Bumper (1976-86 CJs), Rear Corner Braces (Scramblers), Rollbar (76-86), Side Marker Lights (1976-86 CJs), Soft Top Frame (Wrangler), Steering Column Mount, Spare Tire Carrier, Tail Lights (1976-86 CJ's & Wrangler), Tailgate Hinges (CJs), Transmission Cover, Visor (does both Hardtop & Wrangler), Windshield & Door Hinges (1976-86 CJs & Wrangler), Windshield Hinges (does both; 1955-86 CJs), Windshield Hold Down Bracket (CJs), Windshield Washer Jets (Wrangler), and Windshield Latch (does both)!

BODY KITS FOR CJ5, CJ6, CJ7, CJ8 & WRANGLER:

1955-1971 CJ 5 & CJ 6 - 476 PIECES!

BUTTON HEAD	# 6-2464	\$ 260.00
HEX HEAD	6-2465	250.50
ORIGINAL STYLE - INDENTED HEX	6-2466	285.25

1972-1975 CJ 5 - WITHOUT TAILGATE - 464 PIECES!

BUTTON HEAD	6-2467	280.25
HEX HEAD	6-2468	285.50
ORIGINAL STYLE - INDENTED HEX	6-2469	320.00

1972-1975 CJ 5 & CJ 6 - WITH TAILGATE - 547 PC!

BUTTON HEAD	6-2473	290.25
HEX HEAD	6-2474	310.75
ORIGINAL STYLE	6-2475	340.00

1976-1984 CJ 5 - WITHOUT TAILGATE - 640 PIECES!

BUTTON HEAD	6-2476	335.00
HEX HEAD	6-2477	330.00
ORIGINAL STYLE - INDENTED HEX	6-2478	355.00

1976-1984 CJ 5 - WITH TAILGATE - 676 PIECES!

BUTTON HEAD	6-2479	350.50
HEX HEAD	6-2480	350.75
ORIGINAL STYLE - INDENTED HEX	6-2481	380.00

1976-1986 CJ 7 SOFT TOP - 680 PIECES!

BUTTON HEAD	# 6-2482	\$ 360.00
HEX HEAD	6-2483	350.50
ORIGINAL STYLE - INDENTED HEX	6-2484	380.50

1976-1986 CJ 7 HARD TOP - 735 PIECES!

BUTTON HEAD	6-2485	405.75
HEX HEAD	6-2486	395.75
ORIGINAL STYLE - INDENTED HEX	6-2487	430.00

CJ 8 SCRAMBLER SOFT TOP - 704 PIECES!

BUTTON HEAD	6-2488	380.50
HEX HEAD	6-2489	375.25
ORIGINAL STYLE - INDENTED HEX	6-2490	410.00

CJ 8 SCRAMBLER HARD TOP - 780 PIECES!

BUTTON HEAD	6-2491	410.00
HEX HEAD	6-2492	400.50
ORIGINAL STYLE - INDENTED HEX	6-2493	455.00

1987-1995 WRANGLER SOFT TOP - 731 PCS!

BUTTON HEAD	6-2497	390.75
HEX HEAD	6-2498	380.00
ORIGINAL STYLE - INDENTED HEX	6-2499	410.75

1987-1995 WRANGLER HARD TOP - 728 PCS!

BUTTON HEAD	6-2494	400.75
HEX HEAD	6-2495	390.25
ORIGINAL STYLE - INDENTED HEX	6-2496	425.75

** NOTE ORIGINAL STYLE BOLTS ARE MADE IN USA **

TOLL FREE ORDER LINE : 1-800-767-4781

-SEE NEXT PAGE FOR ACCESSORY KITS-

ACCESSORY KITS FOR JEEPS

(NOT INCLUDED IN THE BODY KIT)

AXLE STOP BUMPER MOUNT KITS*

- FOR 1976-1986 CJs			
BUTTON HEAD	# 6-2095	\$ 6.25	
HEX HEAD	6-2096	6.75	
INDENTED HEX HEAD	6-2097	9.00	

BRAKE & FUEL LINE BRACKETS KITS*

- FOR 1976-1986 CJs			
BUTTON HEAD	6-2076	10.50	
HEX HEAD	6-2077	12.00	
INDENTED HEX HEAD	6-2078	18.50	

DOOR ASSEMBLY KITS FOR:

CJ HARDTOP	6-2254	27.75	
WRANGLER SOFTTOP	6-2255	7.00	
WRANGLER HARDTOP	6-2256	19.00	

ENGINE MOUNTS TO FRAME KITS*

- FOR 1976-1986 CJs STRAIGHT SIX:			
SIX POINT - HIGH STRENGTH	6-3561	83.50	
TWELVE POINT - HIGH STRENGTH	6-3562	86.25	
- FOR 1976-1986 CJs WITH V-8:			
SIX POINT - HIGH STRENGTH	6-2259	65.50	
TWELVE POINT - HIGH STRENGTH	6-2260	69.00	

ENGINE KITS FOR AMC - SEE PAGES 8-9

KITS FOR CJ's WITH F134 4 CYLINDERS

ENGINE KIT - HEX HEAD	6-2950	102.50	
BELLHOUSING - SIX POINT	6-2960	101.00	
TRANSMISSION KIT - SIX POINT	6-2965	12.75	
TRANS. TO BELL HOUSING	6-2961	33.00	
TRANSFER CASE TO TRANS.	6-2963	18.75	
TRANSFER CASE TO FRAME	6-2962	120.50	
TRANSFER CASE COVER - HEX	6-2966	22.00	
BALL PIVOT FOR CLUTCH MOUNT	6-2964	10.25	
PEDALS MOUNTING KIT	6-2049	19.75	

TAILGATE SHOULDER BOLTS FOR CJ

SHOULDER BOLTS & WASHERS	6-2004	170.00	
--------------------------	--------	--------	--

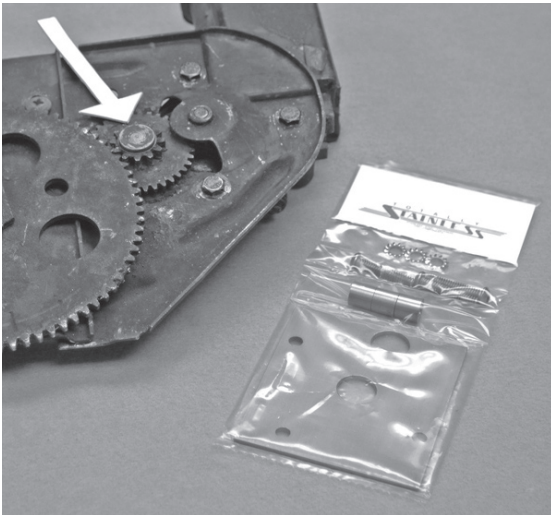

FRONT SHOCK BRACKET KITS*

-BOLT ON TYPE - FOR 1976-1986 CJs			
SIX POINT - HIGH STRENGTH	# 6-2233	\$ 48.50	
TWELVE POINT - HIGH STRENGTH	6-2234	49.25	

GAS TANK GUARD KITS* - FOR 1976-1986 CJs

BUTTON HEAD	6-2035	12.50	
HEX HEAD	6-2036	12.75	

SNAP KIT FOR SOFT TOPS

PHILLIPS HEAD & SNAPS	6-2000	11.50	
-----------------------	--------	-------	--

SWAY BAR KITS*

- FOR 1976-1986 CJs			
SIX POINT - HIGH STRENGTH	6-2261	62.50	
TWELVE POINT - HIGH STRENGTH	6-2262	63.50	

STEERING BOX COVER & MOUNT KITS*

-FOR 1976-1986 CJs			
SIX POINT - HIGH STRENGTH	6-2067	65.50	
TWELVE POINT - HIGH STRENGTH	6-2068	68.50	

SUSPENSION KITS* - HIGH STRENGTH

STAINLESS BOLTS & U-BOLTS WITH COTTER PINS,

**CASTLE NUTS NOT INCLUDED - SEE PAGE 130*

- FOR 1972-1975 CJ 5 & 1986 WITH DANA 44 REAR:

SIX POINT - HIGH STRENGTH	6-2258	602.25	
---------------------------	--------	--------	--

- FOR 1976-1985 CJs & 1986 WITH AMC 20 REAR:

SIX POINT - HIGH STRENGTH	6-2253	609.50	
---------------------------	--------	--------	--

- FOR WRANGLERS:

SIX POINT - HIGH STRENGTH	6-2257	783.75	
---------------------------	--------	--------	--

TRANSFER CASE CROSSMEMBER KITS

- FOR 1976-1986 CJs			
SIX POINT - HIGH STRENGTH	6-2263	26.00	
TWELVE POINT - HIGH STRENGTH	6-2264	28.00	

WOODEN BOARD MOUNT KITS - FOR

SCRAMBLER (CJ-8)			
BUTTON HEAD	6-2213	16.50	
HEX HEAD	6-2214	16.75	

CHASSIS KIT - INCLUDES ALL KITS WITH AN *

BESIDE THE TITLE - HIGH STRENGTH

SIX POINT - POLISHED # 6-2276 \$ 911.75

TAILGATE WINDOW DRIVE SUPPORT
FOR WAGONEER ELIMINATES BINDING SO YOU CAN
USE THE ELECTRIC WINDOW!
 INCLUDES SCREWS, LOCK WASHERS & SPACERS
 # 8-3000 \$ 54.00



TOLL FREE ORDER LINE : 1-800-767-4781

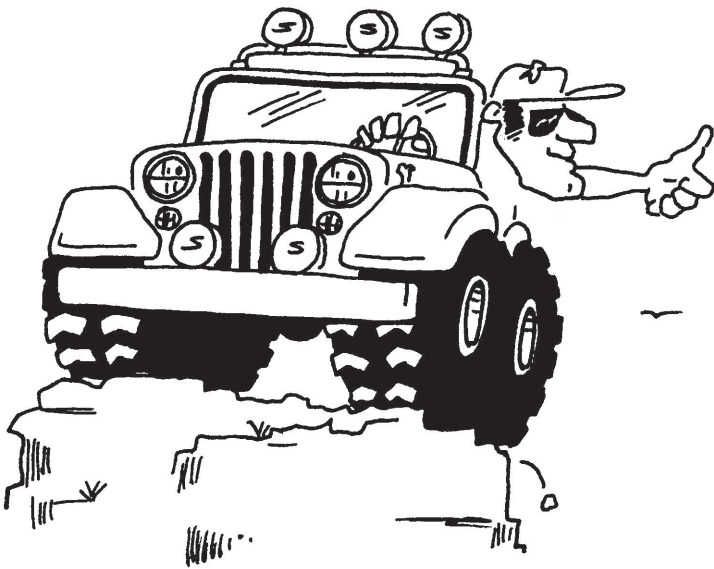

KITS FOR 1954 NASH METRO

BODY KIT - Every Body Kit includes one of each component kit: Bumpers, Bumper Guards, Headlights, Heater & Heater Hose Covers, Heater Fan Mounts, Dash Support, Window Frame, Outer Door Handles, Buttons, & Bezels, Door Hinges, Door Jambs, Window Regulators, Window Stops, Under Dash, Emergency Brake & Cable Guide, Seat Rails to Body (Seat Mounts), Interior, Spare Tire to Body, Wheel Brake Cylinders, Gas Tank, License Plate, Tail Lights, Grill to Body, Radiator to Body, Front Fenders to Body, Hood Hinges, and Trunk Striker to Body.

Contains one of each component kit
 HEX/PHILLIPS HEAD - ORIGINAL STYLE
 BUTTON/FLAT SOCKET - CUSTOM STYLE

6-9800
 6-9836

\$ 250.00
 275.00

ACCESSORY KITS (NOT INCLUDED IN THE BODY KIT)

CONVERTIBLE TOP KIT WITH SHOULDER BOLTS

42 PIECES

6-9829

\$ 158.50

BOLT PACKAGES FOR SUNBEAM TIGER

INFORMATION FOR THESE KITS WAS PROVIDED BY MEMBERS OF THE SUNBEAM TIGER CLUB

839 PC ORIGINAL STYLE BODY KIT: 6-9900 \$250.00

149 PC SIX POINT (HIGH STRENGTH) SUSPENSION KIT: 6-9902 \$450.50

ACCESSORY KITS (NOT INCLUDED IN THE BODY KIT)

ENGINE KITS FOR SMALL BLOCK FORD V8 - SEE PAGES 12-13

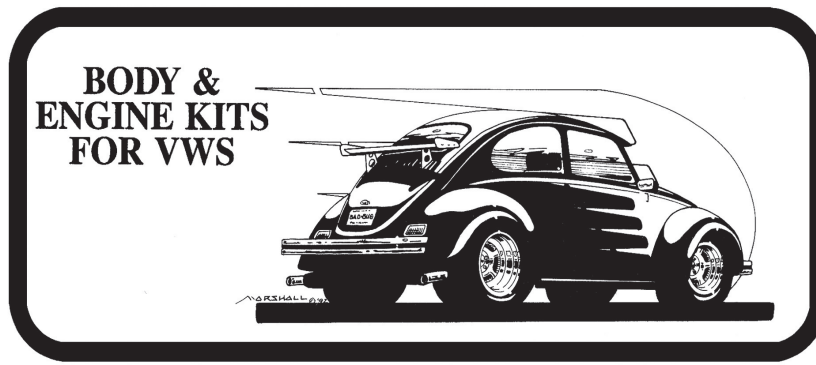

BODY KITS - Each body kit includes component kits for: Basic Engine (Includes all bolts to mount your engine components to the long block, from the intake to the generator, does NOT include the case nuts), Brake Cylinder Mount, Bumpers (with polished carriage), Bumper Brackets (does all 4), Deck Lid (hinges, latches & light housing), Door Hinges, Door Jamb, Engine Tin, Exhaust, Fenders (does all 4), Glove Box, Headlight Rings (with turn signal & tail light screws for '67 & earlier), Hood (does both hinges & latches), Oil Plate, License Plate, Pan & Body Mount, Running Board (does both), Shock Mounts, and Turn Signal Switch screws for '67 & up!

1966 AND EARLIER KITS

		Price
BUTTON & SOCKET HEAD WITH HEX NUTS	5-0097	\$ 240.50
HEX & CHEESE HEAD & PHILLIPS WITH HEX NUTS	5-0098	225.00
SOCKET HEAD WITH HEX NUTS	5-0099	255.75

1967 KITS

BUTTON & SOCKET HEAD WITH HEX NUTS	5-0094	240.00
HEX & CHEESE HEAD & PHILLIPS WITH HEX NUTS	5-0095	225.00
SOCKET HEAD WITH HEX NUTS	5-0096	255.75

1968 AND UP KITS

BUTTON & SOCKET HEAD WITH HEX NUTS	5-0091	245.00
HEX & CHEESE HEAD & PHILLIPS WITH HEX NUTS	5-0004	235.50
SOCKET HEAD WITH HEX NUTS	5-0003	260.50

ACCESSORY KITS (NOT INCLUDED IN THE BODY KIT)

BACK SEAT PIVOT BOLT KIT (2) SHOULDER BOLTS

BUTTON HEAD	# 5-0062	\$ 92.00
HEX HEAD	5-0063	99.75

CONVERTIBLE TOP KIT 1956-67 95 PIECES

HEX HEAD & PHILLIPS HEAD (STOCK)	5-0194	60.50
----------------------------------	--------	-------

FRONT AXLE MOUNTING BOLTS - SET OF 4

- 90 MM LONG BOLTS		
SIX POINT	5-0121	56.50
TWELVE POINT	5-0122	57.75
- 100 MM LONG BOLTS		
SIX POINT - HIGH STRENGTH	5-0087	60.50
12 POINT - HIGH STRENGTH	5-0088	61.00

HOOD HINGE SHOULDER BOLT KITS

BUTTON HEAD	5-0060	42.00
HEX HEAD (STOCK STYLE)	5-0061	42.00

OVER RIDER MOUNTS FOR EARLY BUMPERS

HEX HEAD	5-0020	12.00
SOCKET HEAD	5-0021	11.25

REAR HUB MOUNT BOLT KIT

SIX POINT - HIGH STRENGTH	5-0089	63.00
12 POINT - HIGH STRENGTH	5-0120	64.50

SPRING PLATE HUB COVER KITS

HEX HEAD	5-0107	28.25
SOCKET HEAD	5-0108	30.50
SIX POINT HEAD (POLISHED)	5-0113	48.50
12 POINT HEAD (POLISHED)	5-0114	53.00

STEERING BOX KITS - FOR BOXES THAT MOUNT WITH BOLTS (NOT STUDS)

HEX HEAD	# 5-0109	\$ 40.00
SOCKET HEAD	5-0110	44.50
SIX POINT - HIGH STRENGTH	5-0115	87.25
12 POINT - HIGH STRENGTH	5-0116	95.00

TIE ROD, BUMP STOPS & STABILIZER

HEX HEAD	5-0111	21.75
SOCKET HEAD	5-0112	22.00
SIX POINT - HIGH STRENGTH	5-0117	43.75
12 POINT - HIGH STRENGTH	5-0118	45.00

TRANSAXLE KITS - ALL OF THE NUTS & WASHERS FOR THE OUTSIDE OF THE CASE

-INDEPENDENT TRANSAXLE KIT: 88 PIECES		
NUTS & WASHERS	5-0101	15.50
-SWINGAXLE TRANSAXLE KIT: 93 PIECES		
NUTS & WASHERS	5-0100	17.50

TRANSMISSION MOUNT SHOULDER BOLTS - (1) PAIR

BUTTON HEAD	5-0068	65.00
-------------	--------	-------

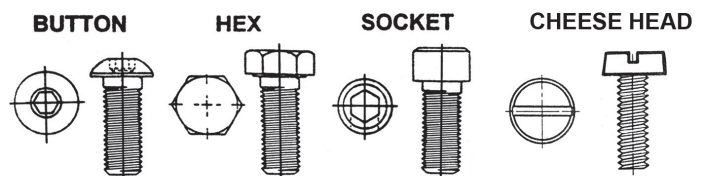

BODY/ENGINE KITS FOR 1967 & EARLIER VW BUSES

BODY KIT - Every Body Kit includes one of each component kit: Basic Engine Kit (everything to mount the Intake, Generator, etc. to the block, does NOT include the case nuts), Bumper Brackets, Engine Tin, Exhaust (for Exhaust Flanges at the Heads & Clamp Bolts & Nuts), Oil Plate (through 1970), Door Hinges (does both front doors), Door Jamb (does both front doors), Engine Compartment Lid, Interior Screws, License Plate, Rear Apron, Rear Bumper, Rear Hatch, and Side Door Hinges & Latches.

Contains one of each component kit

BUTTON & SOCKET HEAD WITH HEX NUTS	# 5-0680	\$ 160.50
HEX & CHEESE & PHILLIPS HEAD WITH HEX NUTS	5-0681	165.50
SOCKET HEAD WITH HEX NUTS	5-0682	170.25

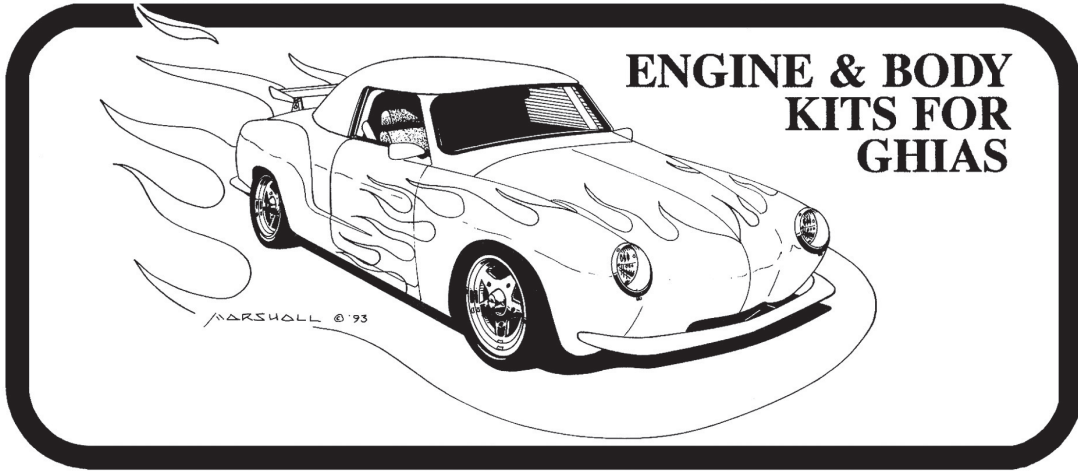

BODY KITS - Each Body Kits includes one of each component kit, including: Basic Engine (Includes all bolts to mount your engine components to the long block, from the intake to the generator, does NOT include the case nuts), Bumper Brackets (does all 4), Deck Lid (does both hinges, latches & light housing), Door Hinges, Door Jamb, Engine Tin, Exhaust, Hood (does both hinges & latches), Oil Plate, License Plate, Pan & Body Mount (does complete pan perimeter & body mounts), and Shock Mounts (does both)!

		Price
- INDEPENDENT REAR		
BUTTON & SOCKET HEAD WITH HEX NUTS	# 5-0553	\$ 180.75
HEX & CHEESE HEAD & PHILLIPS WITH HEX NUTS	5-0551	170.75
SOCKET HEAD WITH HEX NUTS	5-0552	185.50
- SWING AXLE REAR		
BUTTON & SOCKET HEAD WITH HEX NUTS	5-0550	185.50
HEX & CHEESE HEAD & PHILLIPS WITH HEX NUTS	5-0548	175.25
SOCKET HEAD WITH HEX NUTS	5-0549	190.00

ACCESSORY KITS

(NOT INCLUDED IN THE BODY KIT)

SPRING PLATE HUB COVERS KITS

HEX HEAD	# 5-0107	\$ 28.25
SOCKET HEAD	5-0108	30.50
SIX POINT HEAD (POLISHED)	5-0113	48.50
12 POINT HEAD (POLISHED)	5-0114	53.00

TRANSAXLE KITS - ALL OF THE NUTS & WASHERS FOR THE OUTSIDE OF THE CASE

-INDEPENDENT TRANSAXLE KIT: 88 PIECES		
NUTS & WASHERS	5-0101	15.00
-SWINGAXLE TRANSAXLE KIT: 93 PIECES		
NUTS & WASHERS	5-0100	17.50



**NEED USED VW PARTS OR SERVICE?
CALL SAM'S VW SERVICE: 803-359-7289**

KITS FOR HARLEY V-TWINS

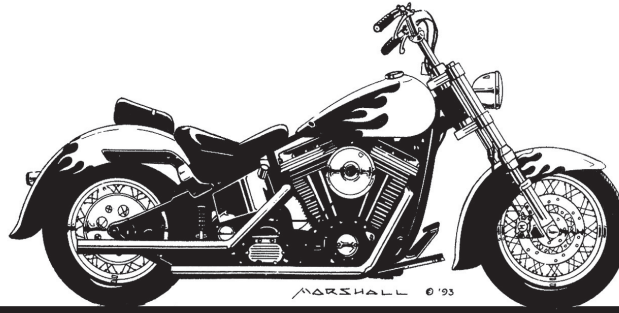

COMPLETE KIT FOR :

2000-2006 SOFT TAIL (FAT BOY HERITAGE): Contains 29 kits for your FLST
from the front rotor to the back rotor/sprocket.

PRICE:

ORIGINAL STYLE # 4-0220 \$ 330.00

ENGINE KITS FOR:

88 TWIN: Contains kits for the crankcase, tappet blocks, air cleaner, oil filter housing, electronic module, rocker covers and starter cover.

BUTTON/SOCKET HEAD 4-0288 56.00

EVO: Contains high crown acorn nuts for the case bolts, oil pump(bolts, cover screws: check, relief, & lifter screen plugs), tappet guide screws, gear case cover screws, and rocker cover screws.

SOCKET HEAD & SIX POINT 4-0300 80.25

SOCKET HEAD & TWELVE POINT 4-0301 81.75

SIX POINT-POLISHED - HIGH STRENGTH 4-0302 112.75

TWELVE POINT-POLISHED - HIGH STRENGTH 4-0303 114.25

SHOVEL HEAD: Contains lock nuts or high crown acorn nuts for the case bolts, oil pump(bolts, cover screws: check, relief & lifter screen plugs), tappet guide screws, gear case cover screws, rocker cover lock nuts or high crown acorn nuts, cylinder base lock nuts or high crown acorn nuts, and head bolts!

SIX POINT -POLISHED - HIGH STRENGTH WITH LOCK NUTS 4-0304 144.50

WITH HIGH CROWN ACORN NUTS 4-0306 222.25

TWELVE POINT-POLISHED - HIGH STRENGTH WITH LOCK NUTS 4-0305 155.25

WITH HIGH CROWN ACORN NUTS 4-0307 227.75

COVER KITS (XL) SPORTSTER:

-1977-1985: Contains screws for; primary, crankcase gear, sprocket covers, & oil level screw.

SOCKET HEAD 4-0007 17.00

-1991-2003: Contains screws for; primary, crankcase gear, sprocket, derby, and inspections covers.

SOCKET HEAD 4-0009 19.00

STAINLESS COMPONENT KITS

CYLINDER BASE NUT KITS - 1948-1984

HIGH CROWN ACORN NUTS # 4-0063 \$ 42.00

NYLON NUTS 4-0065 12.00

ENGINE MOUNT KITS FOR:

-FL/FLH 1948-84 - UPPER & LOWER

SIX POINT - HIGH STRENGTH 4-0019 26.25

TWELVE POINT - HIGH STRENGTH 4-0021 27.25

-FLT & FXR - Includes upper stabilizer bolts, nuts for engine bracket, lower mount bolts, and washers

-FLT 1987

SIX POINT - HIGH STRENGTH 4-0023 27.00

TWELVE POINT - HIGH STRENGTH 4-0025 28.75

-FLT 1988-1989

SIX POINT - HIGH STRENGTH 4-0027 22.50

TWELVE POINT - HIGH STRENGTH 4-0028 23.00

-FLT 1991

SIX POINT - HIGH STRENGTH 4-0031 22.50

TWELVE POINT - HIGH STRENGTH 4-0033 23.00

-FLT 1993-1994

SIX POINT - HIGH STRENGTH 4-0035 25.00

TWELVE POINT - HIGH STRENGTH 4-0036 27.25

ENGINE MOUNT KITS FOR: (CONTINUED)

-FXR 1984-1987

SIX POINT - HIGH STRENGTH # 4-0039 \$ 25.25

TWELVE POINT - HIGH STRENGTH 4-0041 26.25

-FXR 1988-1989

SIX POINT - HIGH STRENGTH 4-0043 26.25

TWELVE POINT - HIGH STRENGTH 4-0045 27.25

-FXR 1991-1994

SIX POINT - HIGH STRENGTH 4-0047 33.50

TWELVE POINT - HIGH STRENGTH 4-0048 34.75

SOFT TAIL: Includes upper & lower bolts, nut & washers.

-1984-1989

SIX POINT - HIGH STRENGTH 4-0051 26.25

TWELVE POINT - HIGH STRENGTH 4-0053 27.25

-1991

SIX POINT - HIGH STRENGTH 4-0055 30.50

TWELVE POINT - HIGH STRENGTH 4-0057 31.50

-1993-1997

SIX POINT - HIGH STRENGTH 4-0059 33.50

TWELVE POINT - HIGH STRENGTH 4-0061 34.50

-2000-2006

SIX POINT - HIGH STRENGTH 4-0233 42.00

COMPONENT KITS FOR HARLEY V-TWINS CONTINUED:

GEARCASE/GENERATOR FOR

-FL, FLH 1941-1969: SPECIAL 1/4-24 SOCKET WITH CORRECT 60 DEGREE TAPER HEADS - SUPER TRICK!
POLISHED SOCKET HEAD # 4-0212 \$ 80.00

GEAR & TIMING COVERS FOR

-ALL SHOVEL HEAD AND EVO ENGINES

BUTTON HEAD 4-0076 7.00
SOCKET HEAD 4-0078 7.00
SIX POINT - HIGH STRENGTH 4-0079 18.00
TWELVE POINT - HIGH STRENGTH 4-0081 23.00

HANDLE BAR SWITCHES SCREW KITS FOR

-LATE SHOVEL HEAD

SOCKET HEAD 4-0070 4.50

-EVO

THRU 1994 SOCKET HEAD 4-0072 3.00
1995-1997 SOCKET HEAD 4-0254 3.00
1998-2004 BOTTON HEAD 4-0255 3.00

HEAD BOLTS KITS - FOR 1966-1984 SHOVELHEAD

SIX POINT - HIGH STRENGTH 4-0074 55.50
TWELVE POINT - HIGH STRENGTH 4-0310 56.50

OIL PUMP BOLT KITS FOR

-1980-1996 SHOVEL HEAD AND EVO ENGINES

SIX POINT - HIGH STRENGTH 4-0084 19.00
TWELVE POINT - HIGH STRENGTH 4-0086 20.00

OIL PUMP PLUG SCREWS - CHECK, RELIEF VALVE, & LIFTER SCREEN PLUGS FOR 1979 & UP

SET OF 3 POLISHED 4-0068 35.00

PRIMARY COVERS FOR

-FL, FLH 1955-1964

SOCKET HEAD 4-0088 5.00

-2011 & UP STREET GLIDE

SOCKET HEAD 4-0294 30.00

PRIMARY, DERBY, & INSPECTION COVERS

-FOR FL, FLH, FLH-80 1970-1980

SOCKET HEAD 4-0090 12.00

-FOR FL, FLH 1981-1984

SOCKET HEAD 4-0092 12.00

-FOR FLH-80 1981-1982

SOCKET HEAD 4-0094 12.00

-FOR CLASSIC 1981-1982

SOCKET HEAD 4-0096 12.00

-FOR FLT 1987-1996

BUTTON HEAD 4-0108 12.00
SOCKET HEAD 4-0110 12.00
SIX POINT - HIGH STRENGTH 4-0112 36.75
TWELVE POINT - HIGH STRENGTH 4-0113 37.75

-FOR FLHT 1998 & UP

BUTTON & SOCKET HEAD 4-0311 9.50

-FOR FXR 1984-1994

BUTTON HEAD 4-0100 12.00
SOCKET HEAD 4-0102 12.00
SIX POINT - HIGH STRENGTH 4-0104 41.00
TWELVE POINT - HIGH STRENGTH 4-0106 42.00

-FOR SOFT TAIL 1984-1988

BUTTON HEAD 4-0116 12.00
SOCKET HEAD 4-0118 12.00
SIX POINT - HIGH STRENGTH 4-0120 41.00
TWELVE POINT - HIGH STRENGTH 4-0122 42.00

-FOR SOFT TAIL 1989-1999

BUTTON HEAD 4-0124 12.00
SOCKET HEAD 4-0126 12.00
SIX POINT - HIGH STRENGTH 4-0128 41.00
TWELVE POINT - HIGH STRENGTH 4-0130 42.00

-FOR SOFT TAIL 2000-2006

BUTTON/SOCKET HEAD 4-0229 9.75

-FOR DYNA 1991-1996

BUTTON HEAD 4-0132 12.00
SOCKET HEAD 4-0134 12.00
SIX POINT - HIGH STRENGTH 4-0136 41.00
TWELVE POINT - HIGH STRENGTH 4-0138 42.00

REAR SPROCKET FOR

-1999 & EARLIER FXR & SOFT TAIL

SIX POINT - HIGH STRENGTH # 4-0261 \$ 23.00

-2000 & UP SOFT TAIL

SIX POINT - HIGH STRENGTH 4-0251 25.00

ROCKER BOXES KITS FOR

-FL, FLH, PAN HEAD 1948-1965

SOCKET HEAD 4-0140 33.00

-SHOVEL HEAD 1966-1984

HIGH CROWN ACORN 4-0142 59.50
NYLON LOCK NUTS 4-0144 22.00
STANDARD ACORN 4-0146 32.00

-EVO

BUTTON HEAD 4-0148 5.00
SOCKET HEAD 4-0150 5.00
SIX POINT - HIGH STRENGTH 4-0152 16.00
TWELVE POINT - HIGH STRENGTH 4-0154 17.00

TAPPET GUIDE KITS FOR

-PAN HEAD 1955-1965, FLH - 1/4-24 SOCKET!

POLISHED SOCKET HEAD 4-0155 40.00

SHOVEL HEAD, EVO, & 88 TWIN (1967 & UP)

BUTTON HEAD 4-0160 5.00
SOCKET HEAD 4-0162 5.00
SIX POINT - HIGH STRENGTH 4-0164 16.00
TWELVE POINT - HIGH STRENGTH 4-0166 17.00

TIMING PLUG FOR - STOCK SIZE

-1941-1969 PAN HEAD

POLISHED 4-0213 12.00

-1970 & UP THRU EVO

POLISHED 4-0167 20.50

TRANSMISSION, SIDE COVER FOR

-FL, FLH 1941-1969

HIGH CROWN ACORN 4-0169 22.00
STANDARD ACORN 4-0171 10.00

TRANSMISSION, SIDE COVER, TOP COVER, BEARING HOUSING FOR

-FLT, FXR, SOFT TAIL 1984-1989

BUTTON HEAD 4-0173 14.00
SOCKET HEAD 4-0175 12.00
SIX POINT - HIGH STRENGTH 4-0177 39.00
TWELVE POINT - HIGH STRENGTH 4-0179 40.00

-FLT, FXR, SOFT TAIL 1991-1992

BUTTON HEAD 4-0181 19.00
SOCKET HEAD 4-0183 15.00
SIX POINT - HIGH STRENGTH 4-0185 49.75
TWELVE POINT - HIGH STRENGTH 4-0187 50.75

-FLT 1993-1996

BUTTON HEAD 4-0189 15.00
SOCKET HEAD 4-0191 15.00
SIX POINT - HIGH STRENGTH 4-0193 46.00
TWELVE POINT - HIGH STRENGTH 4-0195 47.00

-FXR 1993-1996

BUTTON HEAD 4-0197 14.00
SOCKET HEAD 4-0199 12.00
SIX POINT - HIGH STRENGTH 4-0201 32.50
TWELVE POINT - HIGH STRENGTH 4-0203 34.75

-SOFT TAIL 1993-1999

BUTTON HEAD 4-0205 14.00
SOCKET HEAD 4-0207 12.00
SIX POINT - HIGH STRENGTH 4-0209 32.50
TWELVE POINT - HIGH STRENGTH 4-0211 34.50

-SOFT TAIL 2000-2006

SOCKET HEAD 4-0234 10.00

TRANSMISSION TOP COVER FOR

-FL, FLH 1965-EARLY 1979 - SPECIAL 1/4-24 SOCKETS!

POLISHED SOCKET 4-0214 56.00

TRANSMISSION SIDE & TOP COVER

-2008 & UP STREET GLIDE SIX SPEED

BUTTON HEAD 4-0370 10.50
SOCKET HEAD 4-0371 12.50
SIX POINT - HIGH STRENGTH 4-0372 55.00
TWELVE POINT - HIGH STRENGTH 4-0373 59.50

SHOP ASSORTMENTS

SHOP ASSORTMENTS HAVE A 16 OR 24 COMPARTMENT METAL BOX WITH A LIST OF CONTENTS, INCLUDING PART NUMBERS FOR EASY REORDER!

MASTER SHOP ASSORTMENTS:

-STREET RODDER SPECIAL: 9,000 PIECES!

CONTAINS (1) EACH OF THE BUTTON, FLAT SOCKET, SOCKET, LOCK NUT/FLAT WASHER, PHILLIPS TRUSS AND, PHILLIPS OVAL SHEET METAL ASSORTMENTS. ALSO INCLUDES THE 6 DRAWER CABINET!
3-3090 \$ 1865.50

-RESTORER'S SPECIAL: 9,170 PIECES!

CONTAINS (1) EACH OF THE INDENTED HEX HEAD, INDENTED HEX WASHER HEAD, PHILLIPS OVAL, NUT/LOCK/WASHER, PHILLIPS OVAL SHEET METAL (WITH JACKSON HEADS), AND PHILLIPS TRUSS SHEET METAL ASSORTMENTS. ALSO INCLUDES THE 6 DRAWER CABINET!
3-3091 3071.75

BOLTS - COURSE THREAD - 16 SIZES RANGING FROM 10-24 X 1/2 THROUGH 3/8-16 X 2 EXCEPT AS NOTED:

BUTTON CAP	635 PC	3-3003	255.50
24 SIZES: 6-32 X 3/8 TO 3/8-16 X 1 1/2	1500 PC	3-3062	287.50
CARRIAGE	515 PC	3-3008	235.00
FLAT SOCKET	635 PC	3-3020	240.00
24 SIZES: 6-32 X 3/8 TO 3/8-16 X 1 1/2	1500 PC	3-3060	260.50
HEX CAP	635 PC	3-3002	295.00
INDENTED HEX	700 PC	3-3017	829.30
INDENTED HEX - BLACK & FLATS	700 PC	3-3016	1021.50
INDENTED HEX WASHER HEAD	600 PC	3-3059	1010.25
SOCKET CAP	635 PC	3-3004	420.75
SIX POINT - POLISHED - HIGH STRENGTH	400 PC	3-3014	1883.50
TWELVE POINT - POLISHED - H.S.	400 PC	3-3015	2019.90

BOLTS - FINE THREAD - 16 SIZES: 10-32 X 1/2 TO 3/8-24 X 1 1/2

BUTTON CAP	635 PC	3-3042	360.50
HEX CAP	635 PC	3-3018	340.00
SOCKET CAP	635 PC	3-3019	347.50
FLAT SOCKET	665 PC	3-3041	351.00
SIX POINT - POLISHED - HIGH STRENGTH	388 PC	3-3069	1838.60
TWELVE POINT - POLISHED - H.S.	388 PC	3-3071	1938.60

MACHINE SCREWS - 24 SIZES: 6-32 X 3/8 TO 5/16-18 X 1

FILLISTER - SLOTTED	1720 PC	3-3055	302.50
FLAT - PHILLIPS	1720 PC	3-3027	211.00
FLAT - SLOTTED	1720 PC	3-3028	310.75
METRIC PHIL. FLAT: 4 X 6 TO 8 X 30	1720 PC	3-3082	311.50
OVAL - PHILLIPS	1720 PC	3-3029	261.75
OVAL - SLOTTED	1720 PC	3-3030	380.50
METRIC PHIL. OVAL: 4 X 6 TO 8 X 30	1720 PC	3-3072	311.25
PAN - PHILLIPS	1720 PC	3-3031	220.50
PAN - SLOTTED	1720 PC	3-3032	307.50
METRIC PHIL. PAN: 4 X 6 TO 8 X 30	1720 PC	3-3068	311.50
ROUND - PHILLIPS	1720 PC	3-3033	202.50
ROUND - SLOTTED	1720 PC	3-3056	347.75
TRUSS - PHILLIPS	1720 PC	3-3034	242.75
TRUSS - SLOTTED	1720 PC	3-3057	351.50

NUTS, FLAT & LOCK WASHER, & LOCK NUTS

HEX NUTS, LOCKS & FLATS - 16 SIZES EXCEPT AS NOTED:

COARSE THREAD: 10-24 TO 3/8-16	2200 PC	3-3005	204.75
24 SIZES: 6-32 TO 3/8-16	3400 PC	3-3061	219.50
FINE THREAD: 10-32 TO 3/8-24	2200 PC	3-3021	185.50
METRIC THREAD: 5-0.8 TO 10-1.5	2000 PC	3-3013	185.00

NUTS, LOCK NUTS & LOCK WASHERS - METRIC

24 SIZES: 5MM - 12MM A2-70	1707 PC	3-3080	170.25
----------------------------	---------	--------	--------

LOCK NUTS & FLATS:

24 SIZES: 6-32 TO 3/8-16	3475 PC	3-3063	276.50
--------------------------	---------	--------	--------

NUT ASSORTMENT - ACORN/HEX/LOCK NUT/WING

COARSE THREAD: 10-24 TO 3/8-16	1010 PC	3-3010	265.00
FINE THREAD: 10-32 TO 3/8-24	1220 PC	3-3022	276.50

NUT ASSORTMENT - ACORN/HEX/JAM & NYLON LOCKS - 24

COARSE THREAD: 10-24 TO 1/2-13	1167 PC	3-3075	315.50
FINE THREAD: 10-32 TO 1/2-20	1062 PC	3-3076	315.50

NUT ASSORTMENT - HEX/JAM/FLANGE & NYLON LOCKS

METRIC THREAD: 5-0.8 TO 10-1.5	1375 PC	3-3067	210.00
--------------------------------	---------	--------	--------

NYLON INSERT LOCK NUTS

COARSE THREAD: 6-32 TO 1/2-13	1460 PC	3-3037	275.50
FINE THREAD: 10-32 TO 1/2-20	900 PC	3-3070	304.75

WASHERS

FLAT WASHERS: #10 TO 3/8	1705 PC	3-3009	155.00
24 SIZES: #10 TO 1/2	2250 PC	3-3066	178.00
LOCK WASHERS: #10 TO 3/8	1705 PC	3-3035	156.00
#6 TO 3/8	3105 PC	3-3078	197.00
FLAT & TRIM WASHERS - METRIC			
5MM-12MM A2-70	2050 PC	3-3081	178.00

BOLTS - METRIC THREAD - 16 SIZES: 5-8 X 12 TO 10-1.5 X 40

BUTTON CAP	640 PC	# 3-3048	\$ 292.00
FLAT SOCKET CAP	600 PC	3-3085	292.00
HEX CAP	620 PC	3-3011	286.50
A4-80 HEX CAP	400 PC	3-3098	655.00
SOCKET CAP	640 PC	3-3012	305.00
A4-80 SOCKET	400 PC	3-3099	670.00

BUTTON SHEET METAL SCREWS - #8 X 3/8 THRU #14 X 1 WITH LARGE OD FLAT WASHERS

1280 PC	3-3092	308.25
---------	--------	--------

PHILLIPS SHEET METAL SCREWS - 16 SIZES:

FLAT # 6 X 3/8" TO #14 X 1 1/2:	1210 PC	3-3025	184.00
OVAL # 6 X 3/8" TO #14 X 1 1/2:	1210 PC	3-3007	225.50
OVAL W/ (8) JACKSON HEAD SCREW SIZES:			
#8 X 1/2 TO #10 TO 1 1/4 (24 SIZES)	1540 PC	3-3040	330.50
PAN # 6 X 3/8" TO #14 X 1 1/2:	1210 PC	3-3006	233.50
TRUSS # 6 X 3/8" TO #14 X 1 1/2:	1210 PC	3-3026	193.00
BLACK STAINLESS SCREWS - 24 SIZES	1760 PC	3-3089	604.00

SLOTTED SHEET METAL SCREWS

- 16 SIZES: # 6 X 3/8" TO #14 X 1 1/2"

FLAT	1210 PC	3-3044	317.75
HEX WASHER	1000 PC	3-3036	255.50
OVAL	1210 PC	3-3039	330.75
PAN	1210 PC	3-3043	319.50
TRUSS	1210 PC	3-3058	322.50

COTTER PIN SHOP SIZE ASSORTMENT

16 SIZES: 3/32 X 1/2 TO 3/16 X 2	1290 PC	3-3049	189.25
24 SIZES: 1/16 X 1/2 TO 1/4 X 2	2175 PC	3-3038	240.50

LINE CLAMP ASSORTMENT - 237 LINE CLAMPS WITH FLEX

LINE BRACKETS AND CLIPS	249 PC	3-3097	1095.80
-------------------------	--------	--------	---------

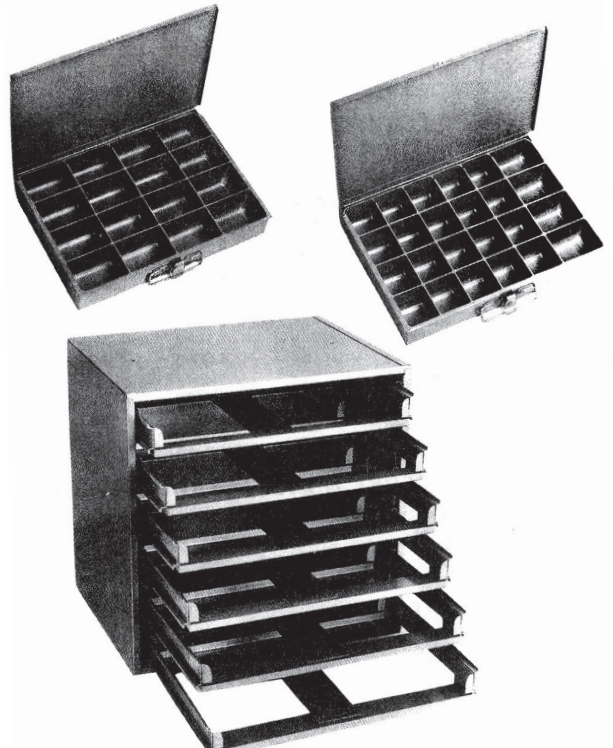

BOXES & METAL CABINETS MADE IN THE USA!

12 COMPARTMENT	# 3-3123	\$ 49.50
16 COMPARTMENT	3-3000	49.50
24 COMPARTMENT	3-3124	49.50
4 DRAWER CABINET	3-3001	171.50
6 DRAWER CABINET	3-3100	250.00

SPECIAL!!! BUY 4 ASSORTMENTS & GET THE 4 DRAWER CABINET FREE!!
BUY 6 ASSORTMENTS AND GET THE 6 DRAWER CABINET FREE!!

PERSONAL ASSORTMENTS

PERSONAL ASSORTMENTS - EACH PERSONAL AUTOMOTIVE ASSORTMENT HAS A 18 COMPARTMENT PLASTIC BOX WITH A LIST OF CONTENTS, INCLUDING PART NUMBERS FOR EASY REORDER!

BOLTS - COARSE THREAD: 8-32 X 3/8 TO 3/8-16 X 1 1/2"

BUTTON CAP	500 PC	# 3-3150	\$ 127.75
FLAT SOCKET	500 PC	3-3155	132.50
HEX CAP	500 PC	3-3151	174.00
INDENTED HEX - OEM STYLE	500 PC	3-3152	393.00
INDENTED HEX WASHER HEAD	350 PC	3-3165	570.50
BLACK INDENTED HEX	400 PC	3-3142	575.45
SOCKET CAP	500 PC	3-3153	161.50
SIX POINT (POLISHED): HIGH STRENGTH	250 PC	3-3137	1142.50
TWELVE POINT	250 PC	3-3138	1230.50

BOLTS - FINE THREAD: 10-32 X 3/8 TO 3/8-24 X 1 1/2"

BUTTON HEAD	400 PC	3-3185	130.00
FLAT SOCKET	400 PC	3-3182	131.00
HEX CAP	400 PC	3-3186	184.00
SOCKET CAP	400 PC	3-3156	164.00

BOLTS - METRIC THREAD: 5-0.8 X 12 TO 10-1.5 X 35 MM

BUTTON CAP	400 PC	3-3190	130.00
FLAT SOCKET	400 PC	3-3191	175.00
HEX CAP	400 PC	3-3192	130.00
SOCKET CAP	400 PC	3-3193	155.00

MACHINE SCREWS - 6-32 X 3/8 TO 1/4-20 X 1"

FILLISTER - SLOTTED	850 PC	3-3157	148.00
FLAT - PHILLIPS	850 PC	3-3158	130.00
FLAT - SLOTTED	850 PC	3-3171	153.00
OVAL - PHILLIPS	850 PC	3-3166	118.90
OVAL - SLOTTED	850 PC	3-3172	157.00
OVAL - METRIC 3-0.5 X 8 TO 8-1.25 X 25	850 PC	3-3197	177.00
PAN - PHILLIPS	850 PC	3-3167	130.00
PAN - SLOTTED	850 PC	3-3173	155.00
PAN - METRIC 3-0.5 X 8 TO 8-1.25 X 25	850 PC	3-3199	205.00
ROUND - PHILLIPS	850 PC	3-3174	130.00
ROUND - SLOTTED	850 PC	3-3175	170.00
SOCKET SET SCREWS 4-40 TO 3/8-16	345 PC	3-3141	130.00
TRUSS - PHILLIPS	850 PC	3-3168	130.00
TRUSS - SLOTTED	850 PC	3-3164	148.00

NUTS, FLAT, & LOCK WASHERS

HEX NUTS, LOCK & FLAT WASHERS:

COARSE THREAD	1200 PC	3-3154	96.25
FINE THREAD	1200 PC	3-3188	95.00
METRIC THREAD	1200 PC	3-3194	95.00

LOCK NUTS & FLATS

COARSE THREAD 8-32 THRU 7/16-14	1077 PC	3-3206	106.00
---------------------------------	---------	--------	--------

LOCK NUTS, LOCK WASHERS & FLATS:

COARSE THREAD	1200 PC	3-3052	107.75
FINE THREAD	1200 PC	3-3189	108.50
METRIC THREAD	1200 PC	3-3195	108.00

FLAT WASHER

#8 TO 7/16"	1200 PC	3-3200	94.00
-------------	---------	--------	-------

V-TWIN SPECIAL: FINE LOCK NUTS/HIGH COLLAR LOCKS/FLATS

8-32 TO 3/8-24	1335 PC	3-3053	115.00
----------------	---------	--------	--------

NUTS/LOCK NUTS/THIN LOCK NUTS: FINE THREAD

10-32 TO 1/2-20	700 PC	3-3187	186.00
-----------------	--------	--------	--------

MASTER SHOP ASSORTMENTS:

- STREET RODDER SPECIAL: 3,700 PIECES!
CONTAINS (1) EACH OF THE BUTTON HEAD, FLAT SOCKET, SOCKET, NYLON LOCK NUT/FLAT WASHER, AND PHILLIPS OVAL SHEET METAL ASSORTMENTS. ALSO INCLUDES THE 5 SHELF CABINET!
3-3169 \$ 687.75

- RESTORER'S SPECIAL: 3,900 PIECES!
CONTAINS (1) EACH OF THE INDENTED HEX HEAD, INDENTED HEX WASHER, PHILLIPS OVAL, NUT/LOCK/WASHER, AND PHILLIPS OVAL SHEET METAL ASSORTMENTS. ALSO INCLUDES THE 5 SHELF CABINET!
3-3170 1450.50



SHEET METAL SCREWS: #6 X 3/8 TO #14 X 1 1/2

BUTTON - #8 X 3/8 - #14 X 1 W/ WASHERS	1270 PC	3-3139	255.00
FLAT - PHILLIPS	1000 PC	3-3176	113.00
FLAT - SLOTTED	1000 PC	3-3177	154.00
OVAL - PHILLIPS	1000 PC	3-3159	112.75
OVAL - PHILLIPS ALSO INCLUDING JACKSON HEAD TRIM SCREWS	1000 PC	3-3161	214.10
OVAL - SLOTTED	1000 PC	3-3163	190.00
PAN - PHILLIPS	1000 PC	3-3178	113.00
PAN - SLOTTED	1000 PC	3-3179	180.00
ROUND - PHILLIPS	1000 PC	3-3180	113.00
ROUND - SLOTTED	1000 PC	3-3181	160.00
TRUSS - PHILLIPS	1000 PC	3-3160	125.50
TRUSS - SLOTTED	1000 PC	3-3162	169.00

COTTER PIN PERSONAL SIZE ASSORTMENT

- 1/16 X 1/2 THROUGH 3/16 X 1 1/2	1000 PC	3-3140	119.00
-----------------------------------	---------	--------	--------

LINE CLAMP: 104 CLAMPS WITH BUTTON HEAD SHEET METAL & MACHINE SCREWS 3-3201 644.00

SPECIAL!! BUY 5 ASSORTMENTS & GET THE 5 SHELF CABINET FREE!!

BOXES & CABINETS MADE IN THE USA!!
18 COMPARTMENT PLASTIC BOX # 3-3051 \$ 17.00
5 SHELF CABINET 3-3105 92.50



TOLL FREE ORDER LINE : 1-800-767-4781



METRIC SIX POINT (SMALL HEX)

HIGH STRENGTH- EQUIVALENT TO METRIC GRADE 10.9 - POLISHED
MADE IN USA

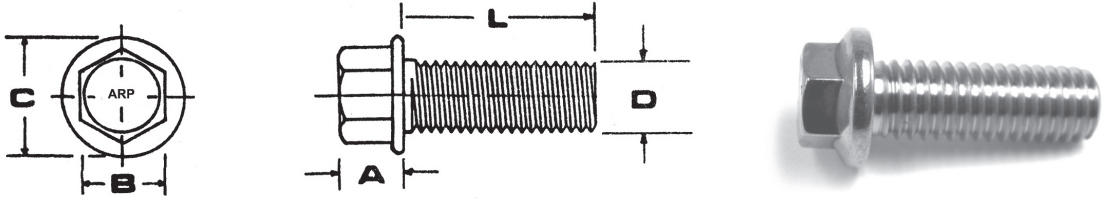

DIMENSION TABLE (MILLIMETERS)

D	DIAMETER	6	8	10	10	12	12
	PITCH	1.0	1.25	1.5	1.25	1.75	1.5
A	HEAD HT.	6.4	7.4	9.3	9.3	11.7	11.7
B	WRENCH	8	10	12	12	14	14
C	FLANGE	13	15	18	18	21.6	21.6

PART NUMBER AND PRICE GUIDE

DIAMETER	6		8		10-1.5		10-1.25		12-1.75		12-1.5	
LENGTH	PART #	\$	PART #	\$	PART #	\$	PART #	\$	PART #	\$	PART #	\$
12	1-2206	4.67										
16	1-2208	4.80	1-2231	5.37								
20	1-2210	4.95	1-2233	5.50	1-2262	6.00	1-2462	6.00				
25	1-2211	5.05	1-2234	5.90	1-2263	6.35	1-2463	6.36	1-2282	9.27	1-2482	9.27
30	1-2212	5.22	1-2235	6.21	1-2264	7.07	1-2464	7.07	1-2283	9.52	1-2483	9.52
35	1-2213	7.55	1-2236	8.21	1-2265	9.58	1-2465	9.58	1-2284	10.23	1-2484	10.23
40	1-2217	7.88	1-2237	8.59	1-2266	9.75	1-2466	9.75	1-2285	10.47	1-2485	10.47
45	1-2218	8.17	1-2238	8.80	1-2267	9.95	1-2467	9.95	1-2286	10.70	1-2486	10.70
50	1-2219	8.38	1-2239	9.00	1-2268	10.64	1-2468	10.64	1-2287	11.76	1-2487	11.76
55			1-2240	9.05								
60	1-2221	9.00	1-2241	9.10	1-2270	11.00	1-2469	11.00	1-2289	12.43	1-2489	12.43
65			1-2242	9.37								
70	1-2223	9.15	1-2243	9.89	1-2272	11.79	1-2470	11.79	1-2291	13.11	1-2491	13.11
80	1-2225	9.35	1-2245	10.40	1-2274	12.36	1-2472	12.36	1-2293	14.25	1-2493	14.25
90	1-2227	9.50	1-2247	10.86	1-2276	13.00	1-2474	13.00	1-2295	15.16	1-2495	15.16
100	1-2229	9.90	1-2249	11.00	1-2278	13.39	1-2476	13.39	1-2297	16.75	1-2497	16.75
114	1-2214	10.26										
115			1-2252	15.63								
135	1-2230	18.65										

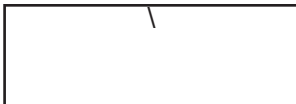

**GREAT FOR SUSPENSION, MOUNTING
ENGINES & TRANSMISSIONS**

**MADE FROM 16-6 AGE HARDENING STAINLESS
GREAT FOR EXHAUST - HAS THE SAME
EXPANSION RATE AS MEDIUM CARBON STEEL**

TUMBLE POLISHED TO A BRIGHT FINISH



TOLL FREE ORDER LINE : 1-800-767-4781

METRIC TWELVE POINT

HIGH STRENGTH - EQUIVALENT TO METRIC GRADE 10.9 - POLISHED
MADE IN USA

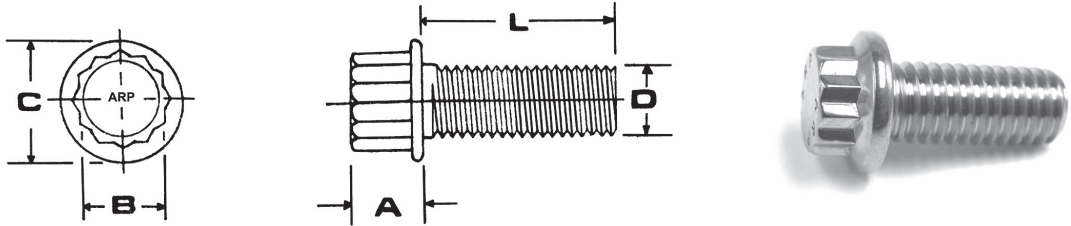

DIMENSION TABLE (MILLIMETERS)

D	DIAMETER	6	8	10	10	12	12
	PITCH	1.0	1.25	1.5	1.25	1.75	1.5
A	HEAD HT.	6.4	7.4	9.3	9.3	11.7	11.7
B	WRENCH	8	10	12	12	14	14
C	FLANGE	13	15	18	18	21.6	21.6

PART NUMBER AND PRICE GUIDE

DIAMETER	6		8		10-1.5		10-1.25		12-1.75		12-1.5	
LENGTH	PART #	\$	PART #	\$	PART #	\$	PART #	\$	PART #	\$	PART #	\$
12	1-2306	5.32										
16	1-2308	5.50	1-2331	5.64								
20	1-2310	5.67	1-2333	5.89	1-2363	6.46	1-2563	6.46				
25	1-2311	5.74	1-2334	5.92	1-2364	6.90	1-2564	6.90	1-2382	8.91	1-2582	8.91
30	1-2312	6.00	1-2335	6.52	1-2365	7.30	1-2565	7.30	1-2383	9.89	1-2583	9.89
35	1-2313	8.20	1-2336	9.07	1-2366	10.07	1-2566	10.07	1-2384	10.07	1-2584	10.07
40	1-2317	8.55	1-2337	9.43	1-2367	10.26	1-2567	10.26	1-2385	10.33	1-2585	10.33
45	1-2318	8.89	1-2338	9.68	1-2368	10.42	1-2568	10.42	1-2386	11.00	1-2586	11.00
50	1-2319	9.17	1-2339	10.12	1-2369	10.64	1-2569	10.64	1-2387	11.76	1-2587	11.76
55			1-2340	10.31								
60	1-2321	9.54	1-2341	10.56	1-2371	11.35	1-2571	11.35	1-2389	12.27	1-2589	12.27
65			1-2342	10.73								
70	1-2323	9.68	1-2343	10.89	1-2373	11.96	1-2573	11.96	1-2391	13.11	1-2591	13.11
80	1-2325	9.78	1-2345	11.00	1-2375	13.31	1-2575	13.31	1-2393	13.97	1-2593	13.97
90	1-2327	10.05	1-2347	11.56	1-2377	13.45	1-2577	13.45	1-2395	14.92	1-2595	14.92
100	1-2329	10.36	1-2349	12.30	1-2379	13.93	1-2579	13.93	1-2397	16.75	1-2597	16.75
114	1-2314	10.70										
115			1-2352	14.72								
135	1-2330	19.25										

TWELVE POINT NUTS

- HIGH STRENGTH -



SIZE	WRENCH	T	A	PART#	\$
6-1.0	8	6.1	10.5	1-3091	10.30
8-1.25	10	8.2	13.5	1-3092	12.51
10-1.5	12	10.3	17.7	1-3093	12.71
10-1.25	12	10.3	17.7	1-3094	12.71
12-1.25	14	12	10	1-3097	12.97



METRIC BUTTON HEAD CAP SCREWS

A2-70 LOW STRENGTH DIN # 7380

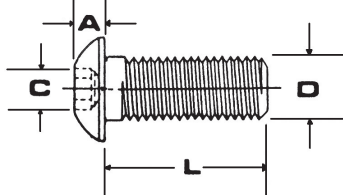
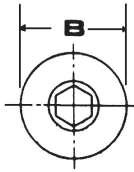

DIMENSION TABLE (MILLIMETERS)

D	DIAMETER	3	4	5	6	8	10	12
	PITCH	0.5	0.7	0.8	1.0	1.25	1.5	1.75
A	HEAD HT.	1.7	2.2	2.8	3.3	4.4	5.5	6.6
B	HEAD DIA.	5.7	7.6	9.5	10.5	14	17.5	21
C	KEY SIZE	2	2.5	3	4	5	6	8

PART NUMBER AND PRICE GUIDE

DIAMETER		2	3	4	5	6	8	10	12							
LENGTH	PART#	\$	PART #	\$	PART #	\$	PART #	\$	PART #	\$	PART #	\$	PART #	\$	PART #	\$
4	1-1371	.29														
6			1-1300	.05	1-1357	.09										
8	1-1382	.59	1-1301	.06	1-1305	.11	1-1309	.12	1-1316	.29						
10			1-1302	.07	1-1306	.13	1-1310	.13	1-1317	.16	1-1323	.39				
12			1-1303	.08	1-1307	.14	1-1311	.17	1-1318	.17	1-1324	.41				
14					1-1354	.15	1-1355	.18	1-1356	.18	1-1358	.43				
16			1-1304	.09	1-1308	.16	1-1312	.19	1-1319	.19	1-1325	.45	1-1329	.89		
20			1-1359	.12	1-1350	.18	1-1313	.22	1-1320	.24	1-1326	.47	1-1330	.94	1-1368	1.29
25					1-1340	.21	1-1314	.25	1-1321	.26	1-1327	.49	1-1331	.99	1-1369	1.36
30					1-1362	.27	1-1315	.29	1-1322	.32	1-1328	.53	1-1332	1.19	1-1370	1.64
35							1-1367	.34	1-1338	.36	1-1336	.59	1-1335	1.28	1-1372	1.75
40					1-1341	.39	1-1363	.41	1-1339	.45	1-1337	.66	1-1334	1.65	1-1347	1.84
45							1-1333	.48	1-1342	.56	1-1366	.74				
50							1-1345	.59	1-1364	.64	1-1346	.83	1-1360	1.98		
55									1-1373	.69	1-1344	1.39				
60									1-1365	.72	1-1351	1.45	1-1361	2.24		
70									1-1343	.85	1-1349	1.69	1-1348	2.49		
80											1-1352	1.95				

BUTTON CAP SCREW SHOP ASSORTMENT: 620 PIECES # 3-3048 \$287.00
 PERSONAL ASSORTMENT: 400 PIECES 3-3190 125.00



METRIC FLAT SOCKET CAP SCREWS

LOW STRENGTH DIN #7991

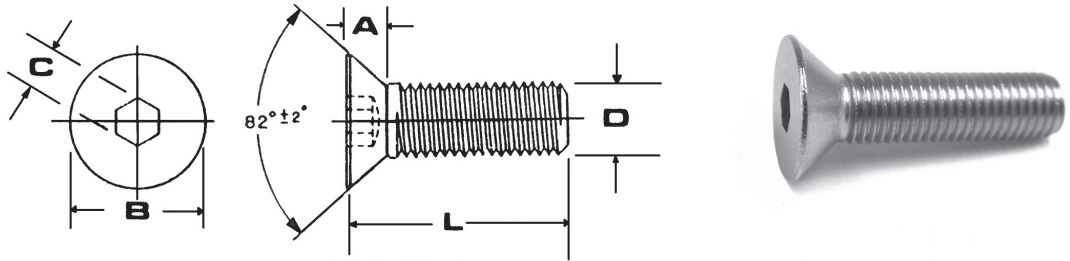

DIMENSION TABLE (MILLIMETERS)

D	DIAMETER	3	4	5	6	8	10	12
	PITCH	0.5	0.7	0.8	1.0	1.25	1.5	1.75
A	HEAD HT.	1.7	2.3	2.8	3.3	4.4	5.5	6.5
B	HEAD DIA.	6	8	10	12	16	20	24
C	KEY SIZE	2	2.5	3	4	5	6	8

PART NUMBER AND PRICE GUIDE

DIAMETER	3		4		5		6		8		10		12	
LENGTH	PART #	\$	PART #	\$	PART #	\$	PART #	\$	PART #	\$	PART #	\$	PART #	\$
6	1-1400	.06												
8	1-1401	.06	1-1408	.10	1-1416	.11								
10	1-1402	.10	1-1409	.12	1-1417	.12	1-1425	.17						
12	1-1403	.11	1-1410	.15	1-1418	.16	1-1426	.19	1-1467	.36				
14			1-1463	.16	1-1462	.16	1-1461	.20	1-1465	.37				
16	1-1404	.12	1-1411	.18	1-1419	.17	1-1427	.23	1-1437	.38	1-1448	.79		
18							1-1464	.25						
20	1-1405	.13	1-1412	.18	1-1420	.18	1-1428	.26	1-1439	.45	1-1449	.82		
25	1-1406	.14	1-1413	.19	1-1421	.21	1-1429	.28	1-1440	.49	1-1450	.86	1-1457	1.35
30	1-1407	.16	1-1414	.22	1-1422	.23	1-1430	.38	1-1441	.57	1-1451	.98		
35			1-1415	.30	1-1423	.35	1-1431	.48	1-1442	.64	1-1452	1.13		
40					1-1424	.42	1-1432	.52	1-1443	.78	1-1453	1.25		
45							1-1433	.66	1-1444	.98				
50			1-1447	.69			1-1434	.75	1-1445	1.19	1-1455	1.38		
55									1-1468	1.25				
60							1-1460	.96	1-1446	1.29	1-1456	1.60		
70							1-1470	.97			1-1458	1.79		
80											1-1459	1.98		

FLAT SOCKET PERSONAL ASSORTMENT: 400 PIECES # 3-3191 \$ 170.00

SHOP SIZE ASSORTMENT: 600 PIECES 3-3085 287.00

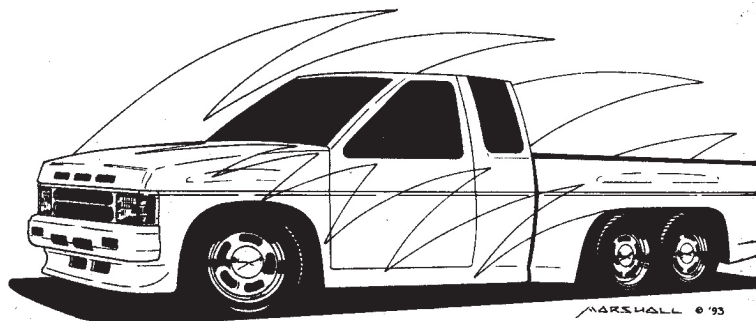

TOLL FREE ORDER LINE : 1-800-767-4781

METRIC HEX HEAD CAP SCREWS

A2-70 LOW STRENGTH DIN #931 (PARTIALLY THREADED)/933 (FULLY THREADED)

DIMENSION TABLE (MILLIMETERS)

D	DIAMETER	3	4	5	6	8	10	12	14	16
	PITCH	0.5	0.7	0.8	1.0	1.25	1.5	1.75	2	2
A	HEAD HT.	2	2.8	3.5	4	5.5	7	8	9	10
B	HEAD DIA.	5.5	7	8	10	13	17	19	22	24

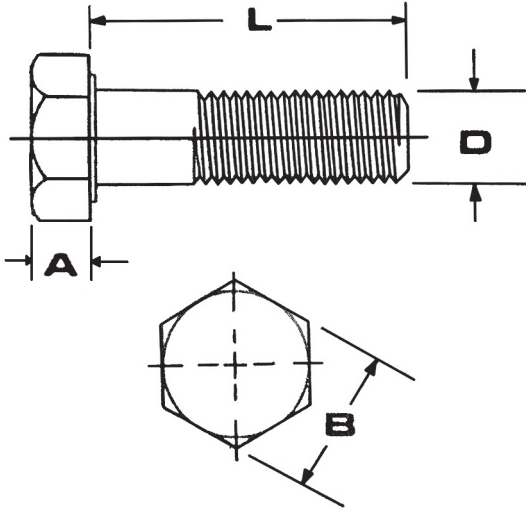

DIAMETER		3		4		5	
LENGTH	PART #	\$	PART #	\$	PART #	\$	PART #
6					1-1515	.16	
8	1-1500	.17	1-1507	.17	1-1514	.17	
10	1-1501	.17	1-1508	.17	1-1516	.17	
12	1-1502	.19	1-1509	.18	1-1517	.19	
16	1-1503	.21	1-1510	.19	1-1518	.21	
20	1-1504	.23	1-1511	.21	1-1519	.23	
25	1-1505	.27	1-1512	.20	1-1520	.26	
30	1-1506	.28	1-1513	.25	1-1521	.29	
35					1-1522	.37	
40					1-1523	.39	
45					1-1524	.41	
50					1-1525	.59	

DIAMETER	6		8		10		12		14		16	
LENGTH	PART#	\$	PART#	\$	PART#	\$	PART#	\$	PART#		PART#	
8	1-1592	.17										
10	1-1526	.18	1-1538	.34								
12	1-1527	.19	1-1539	.36								
14	1-1579	.20										
16	1-1528	.24	1-1540	.38	1-1553	.56						
18	1-1593	.39	1-1614	.38								
20	1-1529	.26	1-1541	.39	1-1554	.58	1-1566	.99				
25	1-1530	.28	1-1542	.43	1-1555	.60	1-1567	1.05				
30	1-1531	.29	1-1543	.56	1-1556	.64	1-1568	1.18				
35	1-1532	.33	1-1544	.60	1-1557	.67	1-1569	1.39			1-1586	2.95
40	1-1533	.36	1-1545	.65	1-1558	.72	1-1570	1.50				
45	1-1534	.39	1-1546	.72	1-1559	.84	1-1571	1.53				
50	1-1535	.44	1-1547	.78	1-1560	.95	1-1572	1.79	1-1583	3.00		
55	1-1536	.53	1-1548	.86	1-1561	1.21	1-1573	1.84				
60	1-1537	.59	1-1549	1.07	1-1562	1.24	1-1574	1.89				
65	1-1581	.80	1-1550	1.13	1-1563	1.49	1-1575	1.94				
70	1-1582	.83	1-1551	1.27	1-1564	1.56	1-1576	1.98				
75			1-1580	1.37	1-1601	1.60	1-1615	1.99				
80	1-1584	.95	1-1552	1.42	1-1565	1.72	1-1577	2.12				
90	1-1585	1.34	1-1578	1.73	1-1590	1.99	1-1595	2.69				
100	1-1597	1.38	1-1587	2.47	1-1591	2.48	1-1596	2.97				
110			1-1699	2.78	1-1599	2.99	1-1603	3.20				
120	1-1598	1.45			1-1602	2.99	1-1600	3.39	1-1604	5.90		
130					1-1605	3.19	1-1589	3.74				
150					1-1606	3.29	1-1594	4.50				
160							1-1608	5.60				
180	1-1588	4.90					1-1610	5.95				
200							1-1612	6.95				

ADDITIONAL SIZE:

18-2.25 X 100
1-1613 \$ 6.49
LOW STRENGTH

METRIC HEX HEAD CAP SCREWS

A4-80 MEDIUM STRENGTH - EQUIVALENT TO METRIC GRADE 8.8
DIN #931 (PARTIALLY THREADED)/933 (FULLY THREADED)

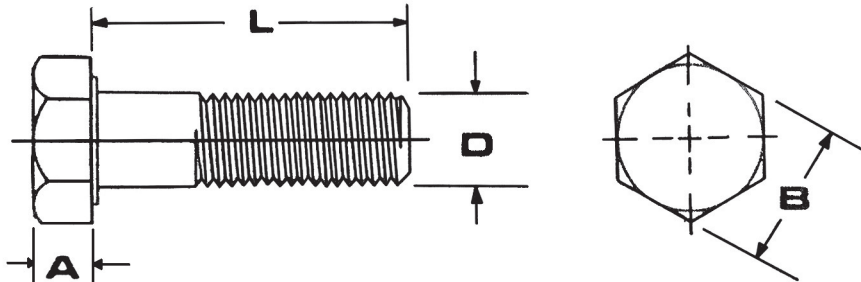

DIMENSION TABLE (MILLIMETERS)

D	DIAMETER	5	6	8	10	12
	PITCH	0.8	1.0	1.25	1.5	1.75
A	HEAD HT.	3.5	4	5.5	7	8
B	HEAD DIA.	8	10	13	17	19

PART NUMBER AND PRICE GUIDE

DIAMETER	5	6	8	10	12					
LENGTH	PART #	\$	PART #	\$	PART #	\$	PART #	\$	PART #	\$
10	1-1616	.55								
12	1-1617	.59	1-1627	.69						
16			1-1628	.74						
20			1-1629	.79	1-1641	1.35				
25			1-1630	.87	1-1642	1.47	1-1655	2.99	1-1667	4.48
30			1-1631	1.07	1-1643	1.59	1-1656	3.19	1-1668	4.67
35					1-1644	1.79	1-1657	3.28	1-1669	4.99
40			1-1633	1.34	1-1645	1.98	1-1658	3.40	1-1670	5.20
45					1-1646	2.26	1-1659	3.55	1-1671	5.47
50			1-1635	1.61	1-1647	2.58	1-1660	3.65	1-1672	5.74
60			1-1636	1.98	1-1650	2.99	1-1663	3.98	1-1674	5.98
70			1-1637	2.15	1-1651	3.49	1-1664	4.45	1-1675	6.84
80			1-1638	2.42	1-1652	3.98	1-1665	4.96	1-1676	6.94
90			1-1639	2.63	1-1653	4.49	1-1666	5.28	1-1677	7.47
100			1-1640	2.90	1-1654	4.80	1-1662	5.76	1-1678	7.98
110							1-1661	6.40		
120										
130										
140							1-1680	7.95		

SHOP SIZE ASSORTMENT: 400 PIECES 3-3098 \$ 650.00

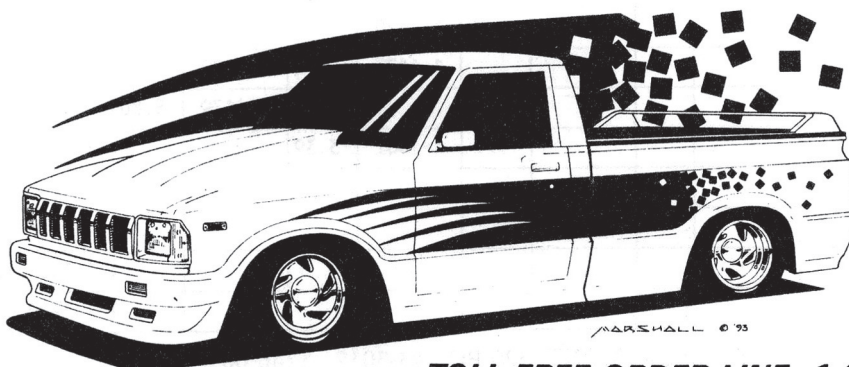

TOLL FREE ORDER LINE: 1-800-767-4781

METRIC SOCKET HEAD CAP SCREWS

A2-70 LOW STRENGTH - DIN #912

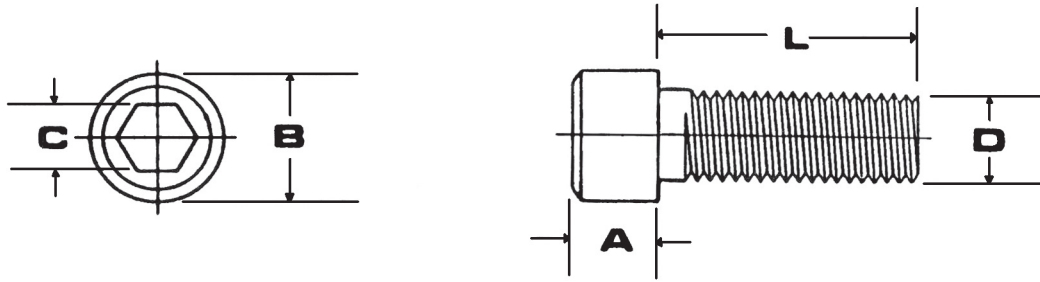

DIMENSION TABLE (MILLIMETERS)

ADDITIONAL
SIZE:
2.5-.45 X 5
1-1009 \$.12

D	DIAMETER	3	4	5	6	8	10	12
	PITCH	0.5	0.7	0.8	1.0	1.25	1.5	1.75
A	HEAD HT.	3	4	5	6	8	10	12
B	HEAD DIA.	5.4	6.9	8.3	10	13	16	18
C	KEY SIZE	2.5	3	4	5	6	8	10

SOCKET CAP SCREW SHOP
ASSORTMENT: 620 PIECES
#3-3012 \$295.95
PERSONAL ASSORTMENT:
400 PIECES #3-3193 \$150.00

PART NUMBER AND PRICE GUIDE

DIAMETER	3	4	5	6	8	10	12							
LENGTH	PART#	\$	PART#	\$	PART#	\$	PART#	\$	PART#	\$	PART#	\$	PART#	\$
4	1-1006	.13												
6	1-1100	.14	1-1112	.17	1-1126	.27	1-1140	.35						
8	1-1101	.15	1-1113	.18	1-1127	.22	1-1141	.32						
10	1-1102	.15	1-1114	.19	1-1128	.23	1-1142	.27	1-1156	.60				
12	1-1103	.16	1-1115	.20	1-1129	.24	1-1143	.25	1-1157	.62				
14	1-1104	.18	1-1116	.22	1-1130	.27	1-1144	.27	1-1158	.64				
16	1-1105	.19	1-1117	.23	1-1131	.28	1-1145	.28	1-1159	.66	1-1170	.96		
18	1-1106	.20	1-1118	.26	1-1132	.30	1-1146	.33	1-1160	.68				
20	1-1107	.21	1-1119	.28	1-1133	.32	1-1147	.34	1-1161	.70	1-1172	.94	1-1189	1.69
22			1-1098	.31										
25	1-1108	.26	1-1120	.33	1-1134	.33	1-1148	.35	1-1162	.72	1-1173	.89	1-1190	1.32
30	1-1109	.33	1-1121	.38	1-1135	.35	1-1149	.39	1-1163	.74	1-1174	.99	1-1191	1.59
35	1-1110	.38	1-1122	.44	1-1136	.40	1-1150	.42	1-1164	.76	1-1175	1.05	1-1192	1.65
40	1-1111	.44	1-1123	.55	1-1137	.41	1-1151	.45	1-1165	.78	1-1180	1.09	1-1193	1.67
45			1-1124	.57	1-1138	.43	1-1152	.49	1-1166	.79	1-1181	1.59	1-1194	1.69
50			1-1125	.59	1-1139	.47	1-1153	.55	1-1167	.89	1-1182	1.30	1-1195	1.72
55					1-1030	.90	1-1015	.58	1-1168	.91	1-1183	1.40	1-1196	2.37
60					1-1031	.90	1-1016	.69	1-1169	.96	1-1184	1.71	1-1197	2.38
65					1-1004	.99	1-1021	.78	1-1036	.99	1-1003	1.85		
70					1-1032	1.06	1-1017	.90	1-1176	1.19	1-1185	1.98	1-1198	2.77
75														
80			1-1008	.88	1-1033	1.29	1-1018	.95	1-1171	1.48	1-1186	2.10	1-1199	2.96
90					1-1034	2.50	1-1019	.99	1-1201	1.90	1-1187	2.49	1-1154	3.27
100					1-1035	4.50	1-1020	1.84	1-1178	2.85	1-1188	2.98	1-1155	3.49
110							1-1177	1.97	1-1099	3.75	1-1005	3.45	1-1000	6.38
120							1-1061	2.48	1-1179	3.80	1-1202	3.95	1-1001	6.96
130							1-1062	3.39			1-1209	4.60	1-1002	7.50
140									1-1014	4.20	1-1203	5.50		
150											1-1206	6.90		
160											1-1207	10.90		
170														
180											1-1208	14.90		

METRIC SOCKET HEAD CAP SCREWS

A4-80 MEDIUM STRENGTH - EQUIVALENT TO METRIC GRADE 8.8 DIN #912

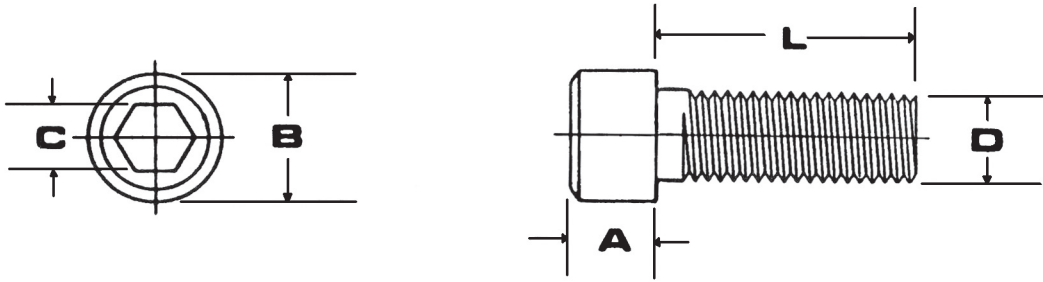

DIMENSION TABLE (MILLIMETERS)

D	DIAMETER	5	6	8	10	12
	PITCH	0.8	1.0	1.25	1.5	1.75
A	HEAD HT.	5	6	8	10	12
B	HEAD DIA.	8.3	10	13	16	18
C	KEY SIZE	4	5	6	8	10

PART NUMBER AND PRICE GUIDE

DIAMETER		5		6		8		10		12	
LENGTH	PART #	\$	PART #	\$	PART #	\$	PART #	\$	PART #	\$	
10			1-1243	.54							
12											
16			1-1245	.65	1-1259	1.19					
20	1-1233	.65	1-1247	.68	1-1261	1.37	1-1272	2.96			
25			1-1248	.70	1-1262	1.46	1-1273	3.24	1-1290	4.80	
30	1-1236	.77	1-1249	.79	1-1263	1.58	1-1274	3.67	1-1291	4.92	
35			1-1250	.87	1-1264	1.75	1-1275	3.94	1-1292	5.16	
40	1-1238	.98	1-1251	.96	1-1265	1.86	1-1280	3.99	1-1293	5.40	
45			1-1252	1.18			1-1281	4.15			
50	1-1240	1.17	1-1253	1.32	1-1267	2.32	1-1282	4.27	1-1295	5.98	
55					1-1268	2.44	1-1283	4.39			
60			1-1255	1.45	1-1269	2.55	1-1284	4.50	1-1297	6.44	
70			1-1256	1.52	1-1276	2.85	1-1285	4.80	1-1298	6.76	
80			1-1257	2.09	1-1271	3.20	1-1289	4.99	1-1299	7.60	
90	1-1234	4.50					1-1287	5.60	1-1200	7.95	
100	1-1235	4.75					1-1288	5.80	1-1220	8.80	
110							1-1286	6.90			

SHOP SIZE ASSORTMENT: 400 PIECES 3-3099 \$ 66500

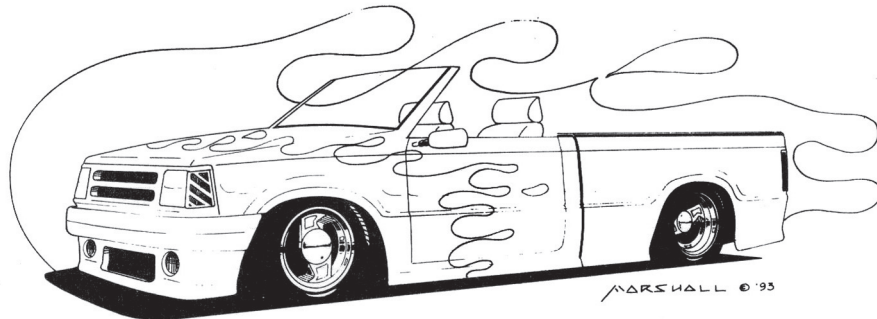

TOLL FREE ORDER LINE : 1-800-767-4781

METRIC STUDS



LOW STRENGTH A2-70

* HIGH STRENGTH - EQUIVALENT TO METRIC GRADE 10.9 *

NOTE: WHEN MEASURING METRIC STUDS, THE LENGTH IS FROM THE MOUNTING SURFACE OUT
 - FOR EXAMPLE ON AN EXHAUST STUD DON'T INCLUDE THE THREADED PART THAT IS IN THE BLOCK.

****BALL END IS ON ARP STUDS ONLY****

SIZE	6 MM		6 MM ARP*		8 MM		8 MM ARP*		10 MM	
LENGTH	PART#	\$	PART#	\$	PART#	\$	PART#	\$	PART#	\$
20	1-1763	1.95	1-1770	8.22	1-1748	1.99				
25	1-1764	1.99			1-1754	2.21	1-1782	7.35		
30	1-1765	1.39			1-1755	2.39	1-1783	7.53		
35	1-1766	2.30			1-1753	2.49	1-1784	7.75		
40	1-1767	2.50			1-1750	2.65	1-1785	8.17	1-1775	3.99
45	1-1768	2.65								
50					1-1751	2.78			1-1759	4.60
55					1-1746	3.19	1-1788	11.22		
60					1-1747	3.83				
70					1-1756	4.26				
80					1-1758	4.74				

NOTE: WE CUSTOM MAKE BOTH LOW AND HIGH STRENGTH STUDS, BALL ENDS ARE AVAILABLE AS AN OPTION

METRIC HEX SOCKET SET SCREWS

DIN #916

SIZE	3 MM		4 MM		5 MM		6 MM		8 MM		10 MM	
LENGTH	PART#	\$	PART #	\$	PART #	\$	PART #	\$	PART #	\$	PART #	\$
4	1-1710	.07										
6			1-1702	.09	1-1720	.11	1-1731	.16				
8			1-1703	.10	1-1721	.13	1-1732	.19	1-1714	.24		
10			1-1704	.12	1-1722	.15	1-1733	.19	1-1715	.29	1-1718	.39
12			1-1705	.14	1-1723	.17	1-1734	.19	1-1716	.35	1-1719	.53
16	1-1712	.15	1-1706	.17	1-1724	.21	1-1738	.28	1-1743	.47	1-1760	.66
20			1-1707	.21	1-1725	.29	1-1739	.35	1-1744	.49	1-1761	.78
25			1-1708	.25	1-1726	.34	1-1735	.35	1-1745	.54	1-1701	.87
30					1-1727	.49	1-1736	.38	1-1730	.59	1-1713	.99
35					1-1728	.93	1-1737	.40				
40					1-1729	.99	1-1740	.50	1-1749	1.09	1-1717	1.59
45							1-1741	.72				
50							1-1742	.75	1-1752	1.82	1-1762	1.98

* 8 X 12 HIGH STRENGTH SET SCREWS - 17-4 PH # 1-1700 \$ 1.98

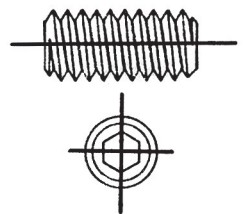

*LONGER SIZES OF SET SCREWS MAKE GREAT CARBURETOR STUDS!

THREADED ROD

- ALL ROD IS SOLD IN (1)METER LENGTHS -

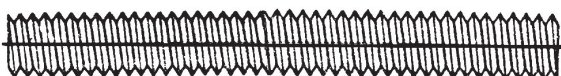

SIZE	PART#	\$
5 MM	1-4905	8.50
6 MM	1-4906	9.90
8 MM	1-4907	12.80
10 MM	1-4908	18.70
12 MM	1-4909	23.90

METRIC CARRIAGE BOLTS

A2-70 LOW STRENGTH DIN #603

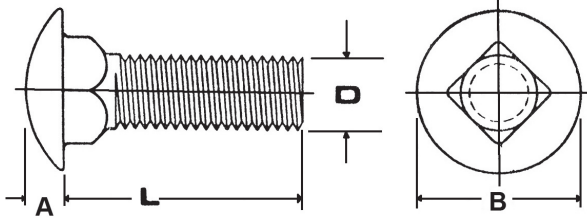

DIMENSION TABLE (MILLIMETERS)

D	DIAMETER	6	8	10	12
	PITCH	1.0	1.25	1.5	1.75
A	HEAD HT.	3.1	4.1	4.6	6.0
B	HEAD DIA.	15	19	23	29

PART NUMBER AND PRICE GUIDE

SIZE	6 MM		8 MM		10 MM		12 MM	
LENGTH	PART #	\$	PART #	\$	PART #	\$	PART #	\$
20	1-1812	.29	1-1809	.49				
25	1-1813	.34	1-1821	.57	1-1853	.79		
30	1-1814	.38	1-1822	.64	1-1854	.89	1-1885	1.59
35	1-1815	.44	1-1823	.69	1-1855	.99	1-1886	1.78
40	1-1816	.49	1-1824	.78	1-1856	1.14	1-1887	1.99
50	1-1817	.55	1-1826	.89	1-1858	1.27	1-1889	3.60
60	1-1818	.66	1-1828	1.09	1-1859	1.39		
70	1-1819	.78	1-1830	1.29				
80	1-1820	.89	1-1832	1.39				
100							1-1896	5.95
120							1-1898	7.80

METRIC CHEESE HEAD MACHINE SCREWS

A2-70 LOW STRENGTH - DIN #84

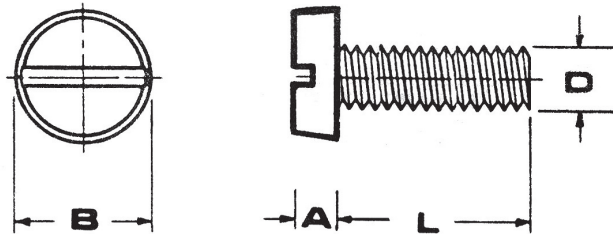

DIMENSION TABLE (MILLIMETERS)

D	DIAMETER	4	5	6	8
	PITCH	0.7	0.8	1.0	1.25
A	HEAD HT.	2.6	3.3	3.9	5
B	HEAD DIA.	7	8.5	10	13

PART NUMBER AND PRICE GUIDE

SIZE	4 MM		5 MM		6 MM		8 MM	
LENGTH	PART #	\$	PART #	\$	PART #	\$	PART #	\$
10	1-4017	.08	1-4027	.12	1-4038	.19		
12	1-4018	.09	1-4028	.15	1-4039	.21		
16	1-4019	.10	1-4029	.19	1-4040	.25		
20	1-4020	.12	1-4030	.22	1-4041	.29	1-4051	.39
25	1-4021	.15	1-4031	.25	1-4042	.35	1-4052	.48
30	1-4022	.18	1-4032	.27	1-4043	.44	1-4053	.55
40	1-4024	.22	1-4035	.33	1-4045	.51	1-4054	.69
45					1-4046	.62		
50					1-4047	.66		

METRIC FLAT HEAD MACHINE SCREWS

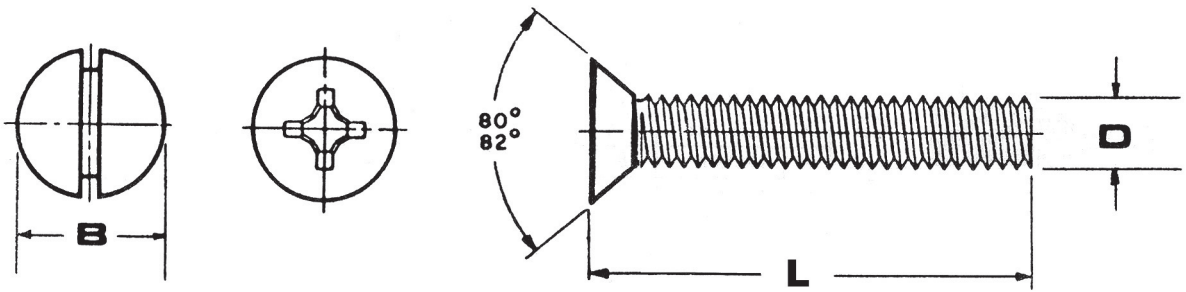

DIMENSION TABLE (MILLIMETERS)

D	DIAMETER	3	4	5	6	8
	PITCH	0.5	0.7	0.8	1.0	1.25
B	HEAD DIA.	5.6	7.5	9.2	11	14.5

SLOTTED HEAD PART NUMBER AND PRICE GUIDE: DIN #963



SIZE	3		4		5		6		8	
LENGTH	PART#	\$	PART#	\$	PART#	\$	PART#	\$	PART#	\$
6	1-4150	.05	1-4162	.09						
8	1-4151	.06	1-4163	.10	1-4175	.13				
10	1-4152	.07	1-4164	.12	1-4176	.14	1-4187	.22		
12	1-4153	.08	1-4165	.13	1-4177	.15	1-4188	.23	1-4197	.45
16	1-4154	.09	1-4166	.14	1-4178	.17	1-4189	.25	1-4198	.49
18					1-4186	.19				
20	1-4155	.10	1-4167	.15	1-4179	.19	1-4190	.27	1-4199	.55
25					1-4180	.22	1-4191	.30		
30							1-4192	.35	1-4201	.66
35			1-4170	.26						
40							1-4194	.41		
45			1-4172	.39						
50							1-4196	.46	1-4205	.98
70							1-4160	.49		

PHILLIPS HEAD PART NUMBER AND PRICE GUIDE: DIN #965



SIZE	3		4		5		6		8	
LENGTH	PART#	\$	PART#	\$	PART#	\$	PART#	\$	PART#	\$
6	1-4210	.07	1-4219	.11						
8	1-4211	.07	1-4220	.12	1-4229	.18	1-4239	.24		
10	1-4212	.08	1-4221	.13	1-4230	.19	1-4240	.27	1-4249	.50
12	1-4213	.09	1-4222	.14	1-4231	.20	1-4241	.29	1-4217	.56
16	1-4214	.10	1-4223	.15	1-4232	.21	1-4242	.33	1-4218	.62
20	1-4215	.11	1-4224	.16	1-4233	.23	1-4243	.36	1-4248	.69
25			1-4207	.18	1-4234	.27	1-4244	.39	1-4208	.78
30			1-4226	.19	1-4235	.29	1-4245	.43	1-4227	.82
35					1-4236	.39	1-4246	.49	1-4238	.85
40					1-4237	.48	1-4247	.59	1-4228	.89
45									1-4209	.91

PHILLIPS FLAT MACHINE SCREW SHOP ASSORTMENT: 1720 PIECES # 3-3082 \$306.50



METRIC OVAL HEAD MACHINE SCREWS

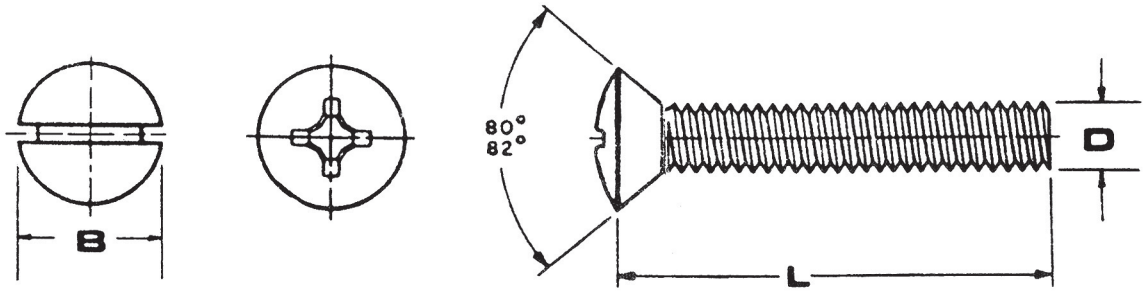

DIMENSION TABLE (MILLIMETERS)

D	DIAMETER	3	4	5	6	8
	PITCH	0.5	0.7	0.8	1.0	1.25
B	HEAD DIA.	5.6	7.5	9.2	11	14.5

SLOTTED HEAD PART NUMBER AND PRICE GUIDE: DIN #964

SIZE	3		4		5		6		8	
LENGTH	PART#	\$	PART#	\$	PART#	\$	PART#	\$	PART#	\$
6	1-4250	.07	1-4262	.12						
8	1-4251	.08	1-4263	.13	1-4275	.27				
10	1-4252	.09	1-4264	.14	1-4276	.27	1-4287	.31		
12	1-4253	.10			1-4277	.28	1-4288	.32		
16	1-4254	.11			1-4278	.29	1-4289	.33	1-4298	.49
20	1-4255	.12	1-4267	.17	1-4279	.30	1-4290	.36	1-4299	.53
25	1-4256	.14	1-4268	.19	1-4280	.33			1-4300	.61
30	1-4257	.19	1-4269	.23	1-4281	.37	1-4292	.44	1-4301	.69
35										
40			1-4271	.39			1-4294	.63		
45							1-4295	.69		
50			1-4273	.55	1-4285	.59	1-4296	.75		
60			1-4274	.58						



PHILLIPS HEAD PART NUMBER AND PRICE GUIDE: DIN #966

SIZE	3		4		5		6		8	
LENGTH	PART#	\$	PART#	\$	PART#	\$	PART#	\$	PART#	\$
6	1-4310	.07	1-4319	.11						
8	1-4311	.08	1-4320	.12	1-4329	.18	1-4339	.28		
10	1-4312	.09	1-4321	.13	1-4330	.19	1-4340	.19		
12	1-4313	.10	1-4322	.14	1-4331	.14	1-4341	.15	1-4349	1.25
16	1-4314	.11	1-4323	.15	1-4332	.18	1-4342	.25		
20	1-4315	.12	1-4324	.16	1-4333	.20	1-4343	.26	1-4351	.53
25	1-4316	.14	1-4325	.19	1-4334	.27	1-4344	.39	1-4352	.74
30			1-4326	.23	1-4335	.31	1-4345	.43	1-4353	.76
35					1-4336	.39	1-4346	.49	1-4354	.98
40			1-4327	.29	1-4337	.49	1-4347	.59	1-4355	1.26
45									1-4356	1.35
50					1-4359	.56	1-4348	.62	1-4360	1.39
60					1-4338	.60	1-4357	.65	1-4358	1.48



**PHILLIPS OVAL ASSORTMENT - SHOP -24 SIZES 3 X 8 THRU 8 X 30 - 1720 PIECES 3-3072 \$306.25
PERSONAL - 18 SIZES - 850 PIECES 3-3197 \$172.00**

TOLL FREE ORDER LINE : 1-800-767-4781

METRIC PAN HEAD MACHINE SCREWS

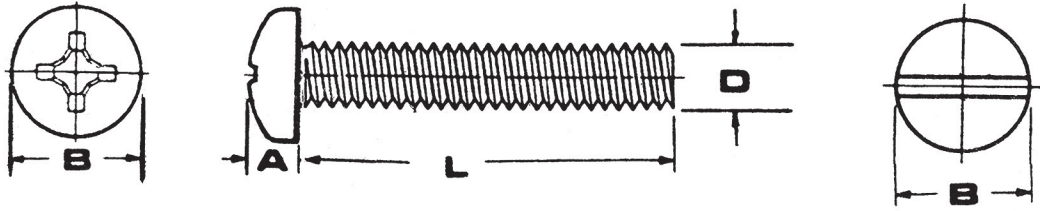

DIMENSION TABLE (MILLIMETERS)

D	DIAMETER	3	4	5	6	8
	PITCH	0.5	0.7	0.8	1.0	1.25
A	HEAD HT. SLOTTED	1.8	2.4	3	3.6	5
A	HEAD HT. PHILLIPS	2.4	3.1	3.8	4.6	6
B	HEAD DIA.	6	8	10	12	16



SLOTTED HEAD PART NUMBER AND PRICE GUIDE

SIZE	2	3	4	5	6	8						
LENGTH	PART#	\$	PART#	\$	PART#	\$	PART#	\$	PART#	\$	PART#	\$
6	1-4106	.04	1-4100	.07	1-4112	.11						
8			1-4101	.08	1-4113	.12	1-4125	.18				
10			1-4102	.09	1-4114	.13	1-4126	.19	1-4137	.25		
12			1-4103	.09	1-4115	.14	1-4127	.21	1-4138	.28	1-4147	.84
16			1-4104	.10	1-4116	.15	1-4128	.23	1-4139	.31		
20			1-4105	.11	1-4117	.17	1-4129	.26	1-4140	.34		
25					1-4118	.19	1-4130	.29	1-4141	.38		
30							1-4131	.33	1-4142	.41		
35									1-4143	.45		
40									1-4144	.49	1-4145	.93



PHILLIPS HEAD PART NUMBER AND PRICE GUIDE

SIZE	3	4	5	6	8					
LENGTH	PART#	\$	PART#	\$	PART#	\$	PART#	\$	PART#	\$
6	1-4060	.07	1-4070	.10	1-4056	.19				
8	1-4061	.07	1-4071	.11	1-4081	.21	1-4078	.36		
10	1-4062	.08	1-4072	.12	1-4082	.19	1-4091	.26	1-4069	.99
12	1-4063	.08	1-4073	.13	1-4083	.21	1-4092	.27	1-4079	.76
16	1-4064	.09	1-4074	.14	1-4084	.23	1-4093	.29	1-4080	.80
20	1-4065	.10	1-4075	.16	1-4085	.26	1-4094	.33	1-4099	.85
25	1-4066	.12	1-4076	.18	1-4086	.29	1-4095	.36	1-4058	.89
30	1-4067	.16	1-4077	.20	1-4087	.32	1-4096	.40	1-4110	.97
35	1-4059	.18	1-4057	.22	1-4088	.35	1-4097	.44	1-4111	1.15
40			1-4055	.23	1-4089	.39	1-4098	.49	1-4122	1.18
45					1-4090	.87	1-4134	.53		
50			1-4049	.24						
60							1-4124	.85	1-4109	1.25
70							1-4068	.92		

PHILLIPS PAN ASSORTMENT - SHOP - 24 SIZES 3 X 8 THRU 8 X 30 - 1720 PIECES - 3-3068 \$306.50
 PERSONAL - 18 SIZES 850 PIECES - 3-3199 \$ 199.95



METRIC NUTS

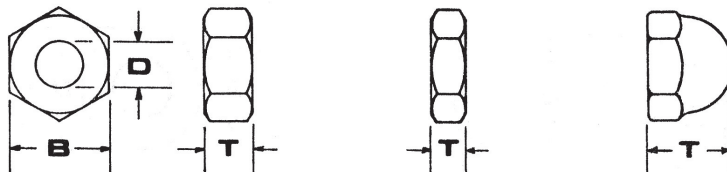

SEE PAGE 73 FOR TWELVE POINT NUTS

SIZE	PITCH	WRENCH	FULL HEX: DIN #934			JAM NUT: DIN #439			ACORN NUT: DIN #1587		
D		B	T	PART#	\$	T	PART#	\$	T	PART#	\$
3	0.5	5.5	2.4	1-3007	.03	1.8	1-3014	.11	6	1-3000	.65
4	0.7	7	3.2	1-3008	.04	2.2	1-3015	.07	8	1-3001	.45
5	0.8	8	4	1-3009	.05	2.7	1-3016	.06	10	1-3002	.45
6	1.0	10	5	1-3010	.09	3.2	1-3017	.09	12	1-3003	.45
7	1.0	11	5.2	1-3052	.29						
8	1.25	13	6.5	1-3011	.17	4	1-3018	.17	15	1-3004	.59
10	1.5	17	8	1-3012	.29	5	1-3019	.30	18	1-3005	1.10
12	1.75	19	10	1-3013	.49	6	1-3020	.49	22	1-3006	1.69
12	1.75	19	10	1-3061*	1.98	* A4-80 MEDIUM STRENGTH NUT					
14	2.0	22	10.3	1-3036	.84						
16	2.0	24	12.3	1-3053	.99						
20	2.5	30	14.9	1-3037	1.69						
- FINE THREAD -											
8	1.0	13	6.5	1-3048	.48						
10	1.25	17	8	1-3049	.59						
10	1.25	17	8	1-3060*	1.49	* A4-80 MEDIUM STRENGTH NUT					
12	1.50	19	10	1-3050	.64						
14	1.50	22	10.3	1-3051	.98		1-3068	.98			

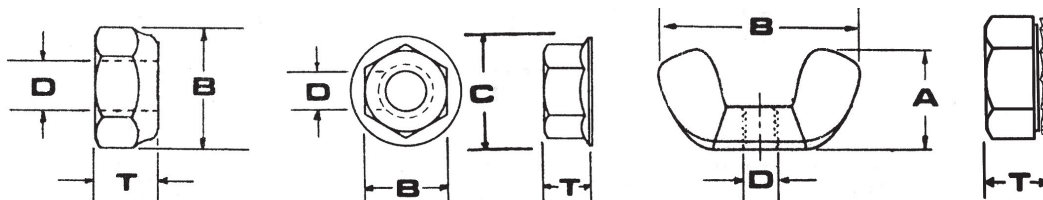

SIZE	NYLON INSERT LOCK NUTS: DIN #985						SERRATED FLANGE NUTS: DIN #6923				WING NUTS: DIN #315				'KEP' NUTS DIN #934K			
D	PITCH	B	T	PART#	\$	C	T	PART#	\$	B	A	PART#	\$	B	T	PART#	\$	
3	0.5	5.5	4	1-3021	.06					19	9.5	1-3030	.91					
4	0.7	7	5	1-3022	.08					19	9.5	1-3031	1.20					
5	0.8	8	5	1-3023	.11	11.5	4.8	1-3058	.15	22	11	1-3032	1.40	8	4	1-3062	.27	
6	1.0	10	6	1-3024	.14	13.4	5.8	1-3054	.19	28	14	1-3033	1.55	10	5	1-3063	.34	
8	1.25	13	10	1-3025	.19	17.1	8	1-3055	.28	30	15	1-3034	1.95	13	6.5	1-3064	.58	
10	1.5	17	10	1-3026	.39	21	10	1-3056	.48	36	18	1-3035	2.35	17	8	1-3066	.99	
12	1.75	19	12	1-3027	.68	25	11.7	1-3057	.86	46	24	1-3038	6.04					
14	2.0	22	14	1-3039	1.07													
16	2.0	24	16	1-3029	1.31													
18	2.25	26	18	1-3028	2.49													
20	2.5	30	20	1-3040	2.98													
- FINE THREAD -																		
12	1.5	19	12	1-3045	2.88													
14	1.5	22	14	1-3046	4.70													

NUT/LOCK/WASHER SHOP ASSORTMENT: 2000 PIECES # 3-3013 \$ 179.95
 PERSONAL ASSORTMENT: 1200 PIECES # 3-3194 \$ 90.00

METRIC SLOTTED HEX NUTS

SIZE	B WRENCH	C COTTER KEY SIZE	PART#	\$
10-1.0	5/8 (16MM)	1/8 X 1-1/4 2-5015	1-3083	15.75
10-1.25			1-3082	
10-1.5			1-3081	
12-1.25	3/4 (19MM)	5/32 x 1-1/4 2-5022	1-3084	18.50
12-1.5			1-3085	
12-1.75			1-3077	
14-1.5	7/8 (22.3MM)	5/32 X 1-1/2 2-5023	1-3086	20.50
14-1.75			1-3087	
14-2.0			1-3079	
16-1.5	1" (25.4 MM)	3/16 X 1-1/2 2-5029	1-3088	23.50
16-1.75			1-3089	
16-2.0			1-3075	

HIGH STRENGTH SLOTTED TALL NUTS
 - MADE IN USA - COMMONLY CALLED "CASTLE NUTS" - USE THESE ON SUSPENSION PARTS (BALL JOINTS, TIE ROD ENDS, IDLER ARMS, ETC.)

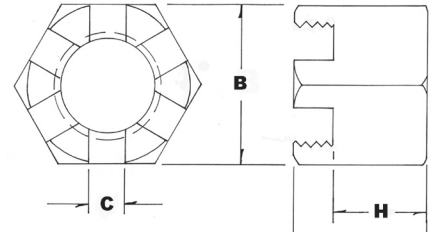

* WE MACHINE THE HEIGHT TO MATCH YOUR NEEDS - SPECIFY (H) DISTANCE FROM BOTTOM OF NUT TO BOTTOM OF SLOTS.

METRIC LOCK WASHERS

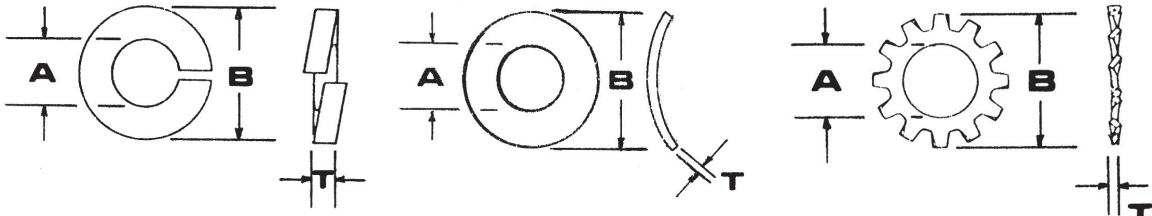

BOLT SIZE	SPLIT LOCK					CURVED SPRING WASHER					EXTERNAL STAR				
	A	B	T	PART #	\$	A	B	T	PART #	\$	A	B	T	PART #	\$
3	3.1	6.2	0.8	1-2100	.03	3.2	6	0.4	1-2107	.03	3.2	6.0	0.4	1-2113	.05
4	4.1	7.6	0.9	1-2101	.03	4.3	8	0.5	1-2108	.04	4.3	8.0	0.5	1-2114	.05
5	5.1	9.2	1.2	1-2102	.04	5.3	10	0.5	1-2109	.06	5.3	10.0	0.6	1-2115	.06
6	6.1	11.8	1.6	1-2103	.06	6.4	11	0.5	1-2110	.07	6.4	11.0	0.7	1-2116	.07
8	8.1	14.8	2.0	1-2104	.08	8.4	15	0.5	1-2111	.12	8.4	15.0	0.8	1-2117	.09
10	10.2	18.1	2.2	1-2105	.14						10.5	18.0	0.9	1-2118	.16
12	12.2	21.1	2.5	1-2106	.19						12.5	20.5	1.0	1-2119	.19
14	14.2	24.1	3	1-2129	.49	15.0	28	1.6	1-2128	.69					
16						17.0	29.5	1.6	1-2131	1.19					

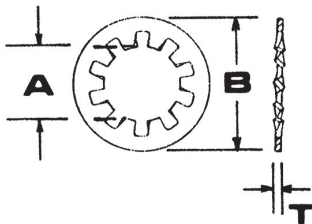

VIBRATION PROOF LOCK WASHERS - 316 SS -

BOLT SIZE	INTERNAL STAR				
	A	B	T	PART #	\$
3	3.2	6	0.4	1-2120	.05
4	4.3	8	0.5	1-2121	.06
5	5.3	10	0.6	1-2122	.06
6	6.4	11	0.7	1-2123	.07
8	8.4	15	0.8	1-2124	.09
10	10.5	18	0.9	1-2125	.15
12	12.5	20.5	1.0	1-2126	.19

SIZE	O.D.	PART#	\$
5MM	8.9MM (.35")	2-4371	1.52
6MM	11.4MM (.45")	2-4374	1.85
6MM	13.5MM (.53")	2-4394	1.95
8MM	13.5MM (.53")	2-4375	2.31
8MM	16.5MM (.65")	2-4395	2.73
10MM	16MM (.62")	2-4377	2.99
10MM	20.8MM (.83")	2-4396	5.20
12MM	19.5MM (.77")	2-4379	3.94
14MM	23.1MM (.91")	2-4380	5.51
16MM	25.44MM (1")	2-4381	5.51

NOTE: (2) PAIRS ARE NEEDED WHEN THE BOLT IS USED WITH A NUT - (1) FOR UNDER THE BOLT & (1) FOR UNDER THE NUT - WILL NOT WORK WITH FLAT WASHERS!

METRIC WASHERS

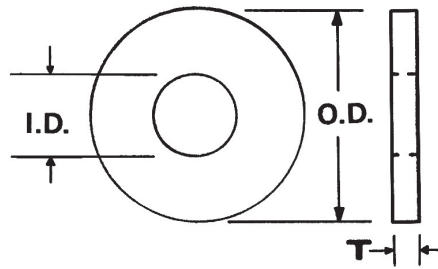

SIZE	NAME	I.D.	O.D.	T	PART#	\$
3 MM	MS803	3.2	6.4	0.5	2-4260	.03
	MS804	3.2	7.9	0.6	2-4224	.03
	#4 STAND	3.2	8.0	0.5	2-4212	.03
	#4 AN	3.2	8.0	0.6	2-4200	.03
	3MM SMALL	3.3	5.7	0.4	1-2000	.03
	3MM STAND	3.3	7.0	0.5	1-2008	.03
	3MM LARGE	3.3	8.8	0.7	1-2016	.03
4 MM	MS806	4.3	9.5	1.0	2-4225	.03
	#8 STAND	4.4	9.5	0.6	2-4214	.03
	4MM SMALL	4.4	8.0	0.5	1-2001	.05
	4MM STAND	4.4	8.9	0.8	1-2009	.03
	4MM LARGE	4.4	11.8	0.9	1-2017	.05
	#8 FENDER	4.4	19.0	1.1	2-4286	.08
	#8 AN	4.5	9.5	0.8	2-4202	.03
5 MM	#10 FENDER	5.2	17.4	1.1	2-4236	.08
	#10 FENDER	5.2	25.4	1.1	2-4237	.13
	#10 AN	5.3	11.1	1.5	2-4203	.03
	5MM SMALL	5.4	8.8	0.9	1-2002	.05
	5MM STAND	5.4	9.9	0.9	1-2010	.03
	5MM LARGE	5.4	15.0	0.9	1-2018	.07
	MS808	5.5	11.1	0.9	2-4262	.03
6 MM	#12 STAND	6.2	12.6	1.0	2-4216	.05
	6MM SMALL	6.5	11.0	1.4	1-2003	.05
	6MM STAND	6.5	12.1	1.4	1-2011	.04
	MS809	6.5	14.2	1.4	2-4227	.06
	6MM LARGE	6.5	17.8	1.4	1-2019	.12
	1/4 HEAVY	6.5	19.0	1.8	2-4277	.27
	1/4 AN	6.7	12.7	1.5	2-4205	.04

SIZE	NAME	I.D.	O.D.	T	PART#	\$	
8 MM	CLEVIS	8.0	16.0	2.0	1-2033	.18	
	MS811	8.1	18.5	1.4	2-4229	.09	
	5/16 HEAVY	8.3	21.6	2.2	2-4248	.38	
	5/16 AN	8.4	14.4	1.4	2-4206	.05	
	8MM SMALL	8.5	14.7	1.4	1-2004	.06	
	8MM STAND	8.5	15.7	1.4	1-2012	.06	
	5/16 STAND	8.6	19.0	1.3	2-4218	.06	
	8MM LARGE	8.6	23.7	1.8	1-2020	.25	
	MS812	8.8	17.4	1.4	2-4264	.06	
	5/16 FENDER	8.8	31.8	1.3	2-4287	.24	
	5/16 FENDER	8.8	38.1	1.3	2-4241	.33	
10 MM	3/8 AN	10.0	16.0	1.4	2-4207	.06	
	CLEVIS	10.0	20.5	2.5	1-2034	.29	
	MS814	10.2	20.7	1.4	2-4265	.07	
	3/8 FENDER	10.2	38.1	1.5	2-4242	.33	
	STRIKER	10.3	25.2	3.0	1-2040	2.50	
	10MM SMALL	10.5	17.6	1.4	1-2005	.13	
	10MM STAND	10.5	19.8	1.9	1-2013	.13	
	10MM LARGE	10.7	29.7	2.3	1-2021	.39	
12 MM	CLEVIS	12.0	25.0	3.0	1-2035	.39	
	CRANK - MOD	12.2	38	6.3	2-4712	10.70	
	7/16 STAND	12.5	28.4	1.3	2-4220	.18	
	12MM SMALL	13.0	20.7	1.9	1-2006	.18	
	12MM STAND	13.0	24.0	2.2	1-2014	.19	
	MS817	13.0	32.0	1.9	2-4232	.23	
	12MM LARGE	13.0	36.1	2.3	1-2022	.59	
	1/2 AN	13.1	22.2	1.3	2-4209	.11	
14 MM	1/2 FENDER	14.2	50.8	1.9	2-4243	.59	
	MS819	14.4	34.8	2.5	2-4233	.39	
	9/16 AN	15.0	26.9	1.5	2-4204	.19	
	14MM STAND	15.0	27.9	2.5	1-2025	.29	
	14MM LARGE	15.0	44.0	3.0	1-2026	.99	
16 MM	5/8 AN	16.3	30.0	1.5	2-4210	.29	
	16MM SMALL	17.1	27.4	2.4	1-2007	.36	
	16MM STAND	17.1	29.7	2.9	1-2015	.34	
	MS820	17.4	33.3	2.0	2-4268	.32	
	5/8 STAND	17.4	39.4	1.9	2-4222	.39	
	16MM LARGE	17.4	50.0	2.9	1-2023	1.24	
18 MM	18MM STAND	19	34	3	1-2029	.39	
	20 MM	MS 822	21	38	2.9	2-4228	.59
		20MM STAND	21	37	3	1-2051	.40
20MM LARGE		22	60	4	1-2028	1.99	

FLAT WASHER ASSORTMENT: 1705 PIECES #3-3009 \$150.00



TOLL FREE ORDER LINE : 1-800-767-4781

SMALL HEX (6 POINT)

STRONG AS GRADE 8 - MADE IN USA - POLISHED

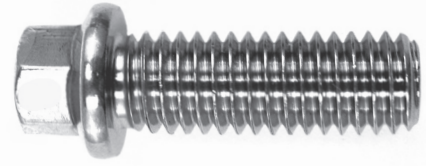
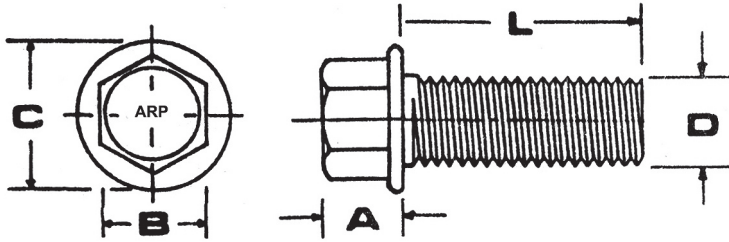

- SMALL FLANGE SHOWN -
1/4 DIA THRU 1" LONG &
5/16-7/16 THRU 1-1/4" LONG
ARE FULLY THREADED

DIMENSION TABLE (INCHES)
NOTE MANY SIZES ARE AVAILABLE IN TWO FLANGE DIAMETERS

D	DIAMETER	1/4	5/16		3/8		7/16	
A	HEAD HEIGHT	.25	.38	.28	.38	.31	.41	.41
B	WRENCH SIZE	5/16	3/8	3/8	3/8	3/8	7/16	1/2
C	FLANGE DIA	.52	.53	.63	.53	.63	.66	.78
THREADS/INCH		20	18	18	16	16	14	14

HEAD BOLTS: 7/16-14 X 2.180 # 2-0852 \$ 9.00
(REDUCED SHANK) X 2.425 2-0854 9.90
X 3.060 2-0855 10.75
X 3.780 2-0856 12.00
X 4.180 2-0858 13.25

PART NUMBER AND PRICE GUIDE

SIZE	1/4-20		5/16-18				3/8-16				7/16-14			
FLANGE:	.52		.53		.63		.53		.63		.66		.78	
LENGTH	PART#	\$	PART#	\$	PART#	\$	PART#	\$	PART#	\$	PART#	\$	PART#	\$
1/2	2-0800	3.41							2-0844	3.80				
9/16					2-0810	3.97								
3/4	2-0804	3.58	2-0870	4.10	2-0813	4.10	2-0830	4.69	2-0880	4.69				
13/16	2-0805	3.60												
7/8					2-0815	4.20	*2-0831	6.15						
1	2-0806	3.66	2-8996	4.40	2-0816	4.40	2-0832	4.86	2-0881	4.86	2-0847	9.17	2-0898	9.17
1 1/4	2-0807	3.70			2-0817	4.64	2-0833	5.23	2-0882	5.23	2-8997	9.28	2-0878	9.28
1 1/2	2-0808	5.15			2-0818	6.21	2-0834	7.20	2-0883	7.20	2-8998	9.48	2-0879	9.48
1 3/4	2-0863	5.30			2-0819	6.53	2-0835	7.58	2-0884	7.58	2-8999	9.74	2-0867	9.74
2	2-0809	5.45	2-0820	6.80	2-0871	6.80			2-0885	7.87	2-8990	9.97	2-0887	9.97
2 1/4	2-0802	5.55			2-0821	6.93			2-0886	8.20	2-8991	10.44	2-0873	10.44
2 3/8							2-0837	8.16						
2 1/2	2-0803	5.68			2-0822	7.16			2-0838	8.50	2-8886	10.95	2-0899	10.95
2 3/4	2-0811	5.78			2-0823	7.33			2-0839	8.73			2-0896	11.60
3	2-0812	5.90			2-0824	7.62			2-0840	9.00	2-8993	12.57	2-0869	12.57
3 1/4					2-0825	7.81			2-0841	9.24			2-0890	12.96
3 1/2	2-0891	6.16			2-0826	7.89			2-0842	10.47	2-8995	13.53	2-0897	13.53
3 3/4					2-0827	8.05			2-0843	10.55			2-0872	14.27
4	2-0894	6.42			2-0814	8.30			2-0864	10.60	2-0857	14.78	2-0874	14.78
4 1/4					2-0862	8.48			2-0859	10.65			2-0875	14.87
4 1/2	2-0895	8.10			2-0861	8.71			2-0865	10.73	2-8894	15.18	2-0892	15.18
4 3/4					2-0829	9.27			2-0845	10.97			2-0866	15.60
5					2-0828	9.41			2-0846	11.15	2-0860	16.45		
6														

ADDITIONAL SIZES: 12-24 X 1 7/8 2-0877 \$ 5.60
12-24 X 2 1/2 2-0876 5.65

*DRILLED FOR 0.032 DIA SAFETY WIRE:
.032 SAFETY WIRE: 2-9900 \$.35/FT (10 FT MIN)

EXTRA SMALL HEAD BOLTS: (5/16" WRENCH)
3/8-16 X 3/4 2-0888 \$ 4.40
3/8-16 X 1 2-0889 4.50

- SEE PAGE 96 FOR FINE THREAD -

SMALL HEX (6PT) SHOP ASSORTMENT: 400 PIECES # 3-3014 \$ 1883.50
PERSONAL SIZE ASSORTMENT: 250 PIECES # 3-3137 \$ 1142.50

SMALL HEX (SIX POINT)

STRONGER THAN GRADE 8 - MADE IN USA - POLISHED

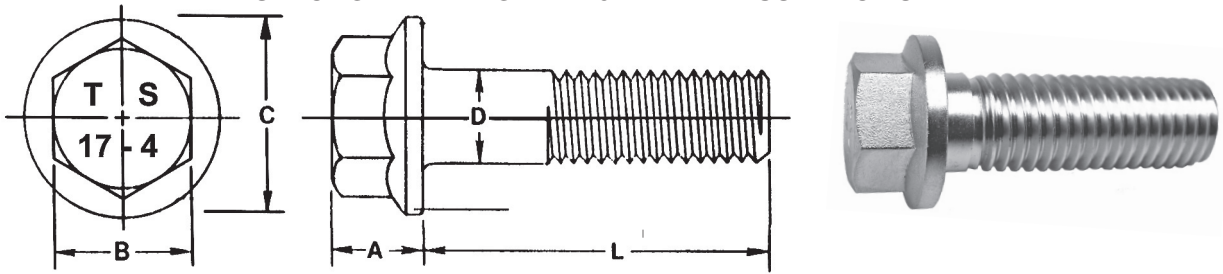

1/2 DIA THRU 6" LONG
ARE MADE BY ARP
ALL OTHER SIZES ARE
CUSTOM MADE FOR
US AND ARE STAMPED
TS 17-4

DIMENSION TABLE (INCHES)

D	DIAMETER	1/2	9/16	5/8	3/4	3/4
A	HEAD HEIGHT	.39	.46	.51	.51	.57
B	WRENCH SIZE	9/16	5/8	3/4	3/4	13/16
C	FLANGE DIA.	.80	.93	1.07	1.07	1.19
THREADS/INCH		13	12	11	18	10

PART NUMBER AND PRICE GUIDE

SIZE	1/2-13		9/16-12		5/8-11		5/8-18		3/4-10		3/4-16	
LENGTH	PART#	\$	PART#	\$	PART#	\$	PART#	\$	PART#	\$		
1	2-3503	8.43										
1 1/4	2-3504	8.99										
1 1/2	2-3505	9.58	2-3560	29.00			2-8731	46.00			2-8750	79.18
1 3/4	2-3506	10.15	2-3561	34.00			2-8732	48.50				
2	2-3507	10.69	2-3520	38.50	2-3531	50.25	2-8733	50.50	2-3550	75.10	2-8752	80.00
2 1/4	2-3508	11.23	2-3562	41.30	2-3571	50.50	2-8734	50.70	2-3551	76.61	2-8753	80.10
2 1/2	2-3509	11.83	2-3521	42.00	2-3532	51.00	2-8735	51.10			2-8744	81.25
2 3/4	2-3510	12.39	2-3563	42.80	2-3573	51.50	2-8736	51.50				
3	2-3511	12.95	2-3522	43.50	2-3533	51.75	2-8737	51.80	2-3552	77.55	2-8746	81.75
3 1/4	2-3512	13.47	2-3564	45.75	2-3565	51.85	2-8738	52.00				
3 1/2	2-3513	14.10	2-3523	48.20	2-3534	52.00	2-8739	52.15			2-8747	82.25
3 3/4	2-3514	14.65	2-3568	49.90	2-3541	52.20	2-8740	52.50	2-3554	78.15		
4	2-3515	15.23	2-3524	51.90	2-3535	52.40	2-8741	52.80				
4 1/4	2-3581	15.80	2-3525	53.60	2-3577	53.00						
4 1/2	2-3516	16.38	2-3526	54.90	2-3536	53.50	2-8743	54.00	2-3555	80.75		
4 3/4	2-3496	17.21	2-3567	56.00								
5	2-3517	17.52	2-3527	57.70	2-3537	56.00	2-8745	56.00	2-3556	81.25		
5 1/2	2-3501	20.05	2-3566	58.90	2-3574	59.00	2-8756	59.00	2-3557	82.25		
6	2-3518	22.65	2-3549	59.90	2-3538	62.15	2-8757	62.15	2-3558	83.28		
6 1/2	2-3569	23.48	2-3528	60.90	2-3578	63.00						
7	2-3570	24.00			2-3539	64.00			2-3559	84.30		
7 1/2	2-3502	24.51			2-3582	65.00						
8	2-3572	25.00	2-3529	73.10	2-3540	66.00						
8 1/2	2-3575	25.55			2-3545	67.00						
9	2-3519	26.00			2-3542	68.90						
9 1/2					2-3583	71.50						
10	2-3548	26.67	2-3530	75.00	2-3543	73.00						
10 1/2					2-3544	75.65						
12					2-3547	77.00						
14					2-3576	80.00						
17					2-3579	85.00						

** ADDITIONAL SIZES: 9/16-18 x 1 1/2 # 2-8726 \$ 30.00
 9/16-18 X 3 1/2 # 2-8722 \$ 47.20
 9/16-18 X 5 1/2 # 2-8728 \$ 59.10

GREAT FOR USE AS SUSPENSION BOLTS!

SMALL HEX (SIX POINT)

STRONG AS GRADE 8 - MADE IN USA - POLISHED

-FINE THREAD-

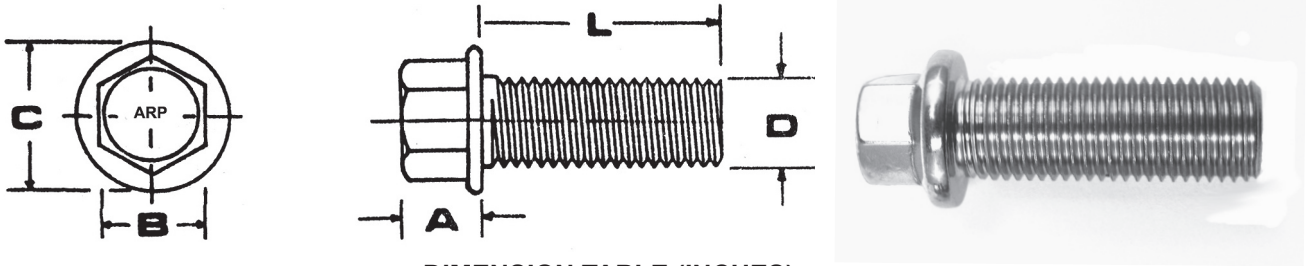

DIMENSION TABLE (INCHES)

D	DIAMETER	1/4	5/16	3/8	7/16	1/2
A	HEAD HEIGHT	.25	.28	.31	.41	.39
B	WRENCH SIZE	5/16	3/8	3/8	7/16	9/16
C	FLANGE DIA.	.52	.63	.63	.66	.80
THREADS/INCH		28	24	24	20	20

PART NUMBER AND PRICE GUIDE

SIZE	1/4-28		5/16-24		3/8-24		7/16-20		1/2-20	
LENGTH	PART#	\$	PART#	\$	PART#	\$	PART#	\$	PART#	\$
1/2	2-8800	3.41								
9/16			2-8821	3.98						
3/4	2-8802	3.53	2-0850	4.07	2-0853	4.51				
1	2-8804	3.72	2-8824	4.51	2-8843	4.67	2-8861	6.08	2-8703	9.30
1 1/4	2-8805	3.78	2-8825	4.90	2-8844	5.16	2-8862	7.51	2-8704	9.89
1 3/8							2-0848	7.54		
1 1/2	2-8806	4.90	2-8826	6.35	2-8845	7.20	2-8863	7.82	2-8705	10.54
1 5/8							2-0849	8.14		
1 3/4	2-8807	5.28	2-8827	6.56	2-8846	7.58	2-8864	8.43	2-8706	11.11
2	2-8808	5.43	2-8828	6.80	2-8847	7.89	2-0851	9.48	2-8707	11.66
2 1/4	2-8809	5.50	2-8829	6.97	2-8848	8.20	2-8866	10.00	2-8708	12.38
2 1/2	2-8810	5.61	2-8830	7.15	2-8849	8.39	2-0868	10.45	2-8709	13.04
2 3/4	2-8811	5.67	2-8831	7.43	2-8850	8.66	2-8867	10.96	2-8710	13.60
3	2-8812	5.82	2-8832	7.58	2-8851	9.08	2-8868	11.96	2-8711	14.16
3 1/4			2-8833	7.81					2-8712	14.72
3 1/2	2-8814	6.46	2-8834	7.91	2-8853	9.71	2-8869	12.93	2-8713	15.51
4	2-8816	6.71	2-8836	8.47	2-8855	10.20	2-8870	13.80	2-8715	16.78
4 1/2	2-8818	7.10	2-8838	9.20	2-8857	10.73	2-8872	14.58	2-8716	17.90
5			2-8840	9.89	2-8859	11.11	2-8874	15.00	2-8717	19.27
5 1/2									2-8718	22.33
6									2-8719	30.16
6 1/2*									2-8720	30.70
7*									2-8721	31.35
7 1/2*									2-8723	32.12
8*									2-8724	32.86

* BOLTS LONGER THAN 6" ARE FORGED FROM 17-4 PH - MARKED TS - STRONGER THAN GRADE 8

SMALL HEX (6 POINT)- FINE THREAD SHOP ASSORTMENT: 388 PIECES # 3-3069 \$ 1838.60

KNURLED SIX POINT BOLTS:

7/16-20 X 2	# 8-2150	\$ 13.25
7/16-20 X 2 1/4	8-2151	14.50
7/16-20 X 2 1/2	8-2152	15.00
1/2-20 X 2 1/4	8-2161	16.75

TWELVE POINT

STRONG AS GRADE 8 - MADE IN USA - POLISHED

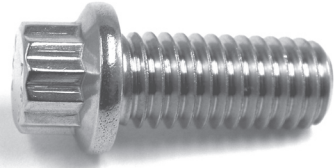
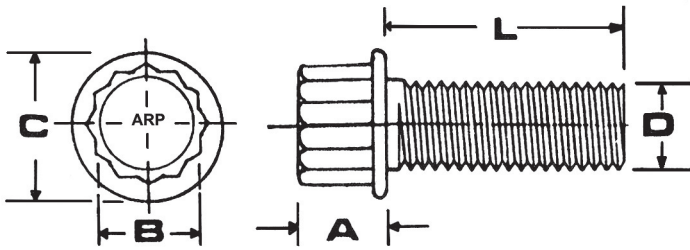

- 1/4 DIA THRU 1" LONG & 5/16-7/16 THRU 1-1/4" LONG ARE FULLY THREADED

DIMENSION TABLE (INCHES)

NOTE MANY SIZES ARE AVAILABLE IN TWO FLANGE DIAMETERS

D	DIAMETER	1/4	5/16	3/8	7/16	1/2			
A	HEAD HEIGHT	.25	.38	.28	.38	.31	.41	.41	.46
B	WRENCH SIZE	5/16	3/8	3/8	3/8	3/8	7/16	1/2	9/16
C	FLANGE DIA	.52	.53	.63	.53	.63	.66	.78	.84
	THREADS/INCH	20	18	18	16	16	14	14	13

PART NUMBER AND PRICE GUIDE

SIZE	1/4-20		5/16-18		3/8-16		7/16-14		1/2-13					
FLANGE:	.52		.63		.53		.63		.66		.78		.84	
LENGTH	PART#	\$	PART#	\$	PART#	\$	PART#	\$	PART#	\$	PART#	\$	PART#	\$
1/2	2-3800	3.70					2-3879	4.14						
9/16			2-3810	4.18										
3/4	2-3804	3.97	2-3813	4.35	2-3830	4.90	2-3880	4.90						
13/16	2-3805	4.18												
7/8			2-3815	4.51	*2-3831	6.45								
1	2-3806	4.32	2-3816	4.68	2-3832	5.20	2-3881	5.20	2-3847	8.56	2-3877	8.56	2-3622	9.27
1 1/4	2-3807	4.51	2-3817	4.86	2-3833	5.50	2-3882	5.50	2-3801	8.64	2-3869	8.64	2-3623	9.89
1 1/2	2-3808	6.05	2-3818	6.88	2-3834	7.40	2-3883	7.40			2-3868	9.62	2-3624	10.54
1 3/4	2-3857	6.22	2-3819	7.17	2-3835	7.95	2-3884	7.95			2-3863	9.75	2-3625	11.14
2	2-3802	6.29	2-3871	7.56	2-3836	8.30	2-3885	8.30			2-3864	10.30	2-3626	11.76
2 1/4	2-3855	6.37	2-3821	7.81			2-3886	8.57			2-3888	10.80	2-3627	12.35
2 3/8					2-3837	8.54								
2 1/2	2-3854	6.50	2-3822	7.90			2-3838	8.70			2-3865	11.35	2-3628	13.00
2 3/4	2-3853	6.58	2-3823	8.05			2-3839	9.26			2-3896	11.60	2-3629	13.63
3	2-3812	6.71	2-3824	8.36			2-3840	9.52			2-3889	12.82	2-3630	14.25
3 1/4			2-3825	8.51			2-3841	9.85			2-3890	13.55	2-3631	14.82
3 1/2	2-3891	7.05	2-3826	8.66			2-3842	10.12			2-3897	14.00	2-3632	15.51
3 3/4			2-3827	8.80			2-3843	10.35			2-3867	14.30	2-3633	16.12
4	2-3894	7.43	2-3859	9.46			2-3860	10.70			2-3898	15.75	2-3634	16.75
4 1/4			2-3858	9.53			2-3861	10.91			2-3876	15.84	2-3635	17.38
4 1/2	2-3895	8.41	2-3814	9.58			2-3862	11.11			2-3899	15.92	2-3636	18.00
4 3/4							2-3851	11.38			2-3878	16.00	2-3637	18.81
5			2-3828	9.81			2-3845	11.65	2-3887	16.35			2-3638	19.27
5 1/2									2-3873	17.30			2-3640	22.11
6									2-3875	18.30			2-3642	30.42

5/16-18 BOLTS WITH SMALL .53 FLANGE

5/16-18 X 3/4" # 2-3870 \$ 7.16

5/16-18 X 2" 2-3820 8.39

3/8-16 BOLTS WITH 7/16 WRENCH HEAD .67 FLANGE

3/8-16 X 2" 2-3685 8.28

3/8-16 X 2 1/2" 2-3687 8.58

***DRILLED FOR SAFETY WIRE**

.032 SAFETY WIRE: 2-9900 \$.35/FT (10 FT MIN)

SPECIAL HEAD BOLTS: 7/16-14 X 2.180 # 2-3872 \$ 9.80

(MAY HAVE REDUCED SHANKS) 2.425 2-3856 10.75

3.060 2-3866 11.57

4.180 2-3852 13.87

TWELVE POINT SHOP ASSORTMENT: 400 PIECES # 3-3015 \$ 2019.90

PERSONAL ASSORTMENT: 250 PIECES # 3-3138 \$ 1230.50

TWELVE POINT
STRONG AS GRADE 8 - MADE IN USA - POLISHED
- FINE THREAD -

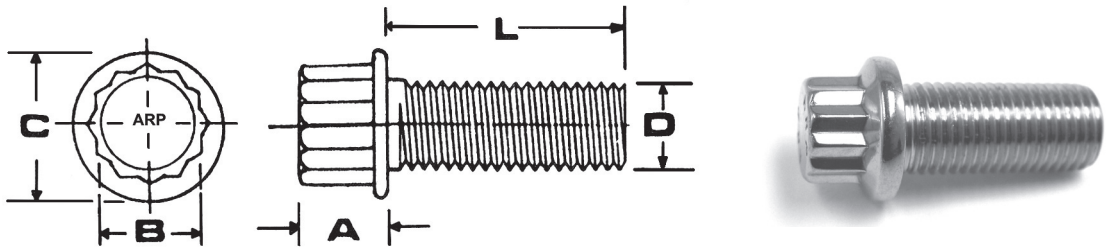

DIMENSION TABLE (INCHES)

D	DIAMETER	1/4	5/16	3/8	7/16	1/2
A	HEAD HEIGHT	.25	.28	.31	.41	.46
B	WRENCH SIZE	5/16	3/8	3/8	7/16	9/16
C	FLANGE DIA.	.52	.63	.63	.66	.84
THREADS/INCH		28	24	24	20	20

PART NUMBER AND PRICE GUIDE

SIZE	1/4-28		5/16-24		3/8-24		7/16-20		1/2-20	
LENGTH	PART#	\$	PART#	\$	PART#	\$	PART#	\$	PART#	\$
1/2	2-3900	3.70								
9/16			2-3921	4.31						
3/4	2-3902	3.90	2-3811	4.51	2-3844	4.97				
1	2-3904	4.24	2-3809	4.75	2-3943	5.20	2-3960	6.22	2-3980	9.28
1 1/4	2-3905	4.28	2-3925	4.86	2-3944	5.50	2-3961	7.66	2-3981	9.89
1 3/8							2-3849	7.89		
1 1/2	2-3906	6.12	2-3926	6.71	2-3945	7.38	2-3962	8.11	2-3982	10.54
1 5/8							2-3846	8.30		
1 3/4	2-3907	6.00	2-3927	7.00	2-3946	7.69	2-3963	8.50	2-3983	11.17
2	2-3908	6.12	2-3928	7.28	2-3947	8.30	2-3848	9.48	2-3984	11.66
2 1/4	2-3909	6.17	2-3929	7.61	2-3948	8.55	2-3964	9.83	2-3985	12.38
2 1/2	2-3910	6.33	2-3930	7.70	2-3949	8.68	2-3850	10.45	2-3986	13.00
2 3/4	2-3911	6.45	2-3931	7.90	2-3950	9.15	2-3965	11.30	2-3987	13.60
3	2-3912	6.51	2-3932	8.06	2-3951	9.42	2-3966	11.94	2-3988	14.17
3 1/2	2-3914	6.75	2-3934	8.40	2-3953	10.00	2-3968	12.62	2-3990	15.51
4	2-3916	7.25	2-3936	9.20	2-3955	10.50	2-3970	13.57	2-3992	16.77
4 1/2	2-3918	7.88	2-3938	9.38	2-3957	10.87	2-3972	14.59	2-3994	17.90
5			2-3940	9.61	2-3959	11.40	2-3974	15.10	2-3996	19.27
5 1/2									2-3997	22.33
6									2-3999	30.15

TWELVE POINT - FINE THREAD SHOP ASSORTMENT: 300 PIECES # 3-3071 \$ 1938.60

KNURLED TWELVE POINT BOLTS: 7/16-20 X 2 # 8-2163 \$ 12.85
 7/16-20 X 2 1/4 8-2164 13.75



TOLL FREE ORDER LINE : 1-800-767-4781

CARRIAGE BOLTS

US COARSE THREAD - LOW STRENGTH

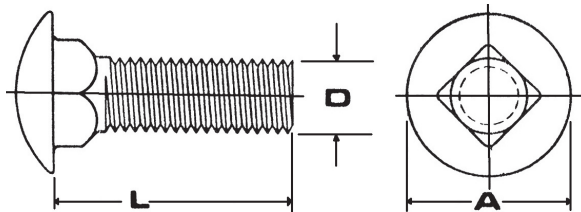

DIMENSION TABLE (INCHES)

D	DIAMETER	3/16 (#10)	1/4	5/16	3/8	7/16	1/2	5/8
A	HEAD DIA.	.45	.58	.71	.81	.92	1.06	1.25
	THREADS/INCH	24	20	18	16	14	13	11

POLISHED CARRIAGE BOLTS:

TO ORDER CARRIAGE BOLTS, ADD A (P) TO THE PART NUMBER, AS AN EXAMPLE 2-0700P, THE EXTRA COST FOR POLISHING IS:

SIZE:	PRICE:	SIZE:	PRICE:
#10	\$.85 EACH	7/16"	\$ 1.50 EACH
1/4"	.95 "	1/2"	2.00 "
5/16"	1.00 "	5/8"	2.50 "
3/8"	1.25 "		

PART NUMBER AND PRICE GUIDE

DIAMETER	3/16 (#10)	1/4	5/16	3/8	7/16*	1/2	5/8							
LENGTH	PART#	\$	PART#	\$	PART#	\$	PART#	\$	PART#	\$	PART#	\$		
1/2	2-0760	.33	2-0700	.23										
5/8	2-0761	.35	2-0701	.25										
3/4	2-0762	.35	2-0702	.25	2-0715	.43	2-0728	.75						
1	2-0763	.38	2-0703	.27	2-0716	.45	2-0729	.85	2-0741	2.95	2-0742	1.79		
1 1/4	2-0764	.40	2-0704	.29	2-0717	.47	2-0730	.95	2-0754	3.15	2-0743	1.88		
1 1/2	2-0765	.42	2-0705	.35	2-0718	.49	2-0731	1.04	2-0755	3.50	2-0744	1.99		
1 3/4			2-0706	.44	2-0719	.59	2-0732	1.14			2-0745	2.19	2-7702	7.70
2	2-0713	.75	2-0707	.48	2-0720	.63	2-0733	1.19	2-0756	10.05	2-0746	2.40		
2 1/4			2-0708	.56	2-0721	.69	2-0734	1.26			2-0747	2.69		
2 1/2	2-7720	.79	2-0709	.62	2-0722	.75	2-0735	1.54	2-0771	10.25	2-0748	2.85		
2 3/4			2-7724	.64	2-7727	.79								
3			2-0710	.65	2-0723	.84	2-0736	1.59	2-0767	10.45	2-0749	3.00	2-0777	7.90
3 1/2			2-0711	.77	2-0724	.96	2-0737	1.66	2-0768	10.59	2-0750	3.16	2-0792	8.50
4			2-0712	.89	2-0725	.99	2-0738	1.79	2-0769	10.75	2-0751	3.38	2-0793	8.90
4 1/2			2-7725	.99	2-7728	1.23	2-0757	1.88	2-0770	10.84	2-0774	3.95		
5			2-7726	1.39	2-0726	1.44	2-0739	1.99	2-0787	11.10	2-0752	4.40		
5 1/2							2-0758	2.26	2-0779	11.23				
6					2-0727	3.76	2-0740	2.39	2-0788	11.45	2-0753	4.80	2-0797	12.90
6 1/2							2-0796	6.80						
7							2-0759	5.50			2-0714	9.90	2-0776	13.80
8					2-7732	4.99	2-0766	5.60			2-0775	10.50		
9							2-0791	6.98			2-0785	10.75		
10							2-0781	7.60			2-0780	11.90		
12							2-0783	8.95			2-0782	11.95		



* 7/16 X 1, 1 1/4 BOLT HAVE A SHORT HEIGHT SQUARE (APPROX. 1/8"), 7/16 X 2 AND LONGER ARE HOT FORGED

**FINE THREAD - 7/16-20 X 1 1/2 CARRIAGE # 2-0786 \$ 12.95 **

** HIGH STRENGTH (17- 4 PH) 3/8-24 X 4 2-0790 \$ 26.00
 3/8-24 X 2 2-0789 25.00

CARRIAGE BOLT SHOP ASSORTMENT: 515 PIECES # 3-3008 \$ 240.50

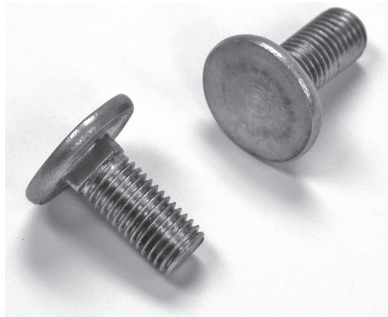

REAR FENDER BOLTS FOR STEPSIDE FORD TRUCKS!

- MADE FOR AFTERMARKET BEDSIDES WITH SQUARE HOLES.
 SPECIAL FLAT HEAD WITH SHORT HEIGHT SQUARE.
 ALSO AVAILABLE IN KITS FOR FORD TRUCKS! -

5/16-24 x 11/16 (WITH SQUARE) # 2-0773 \$ 1.99

BUTTON HEAD CAP SCREWS

- LOW STRENGTH - SEE PAGE 2 FOR HIGH STRENGTH -

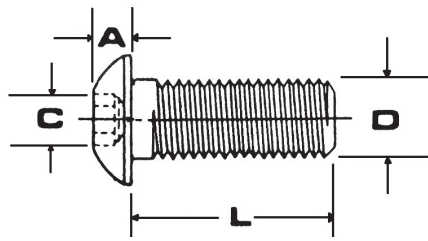
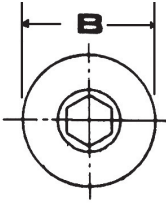

SEE PAGE 2 FOR HIGH STRENGTH (GRADE 8+) BUTTON HEADS

DIMENSION TABLE (INCHES)

D	DIAMETER	1/4	5/16	3/8	7/16	1/2	5/8
A	HEAD HT.	.13	.16	.19	.19	.26	.32
B	HEAD DIA.	.44	.55	.66	.66	.87	1.0
C	KEY SIZE	5/32	3/16	7/32	7/32	5/16	3/8
THREADS/INCH		20	18	16	14	13	11

PART NUMBER AND PRICE GUIDE

** SPECIFY APPLICATION ON ALL 7/16" AND LARGER SIZES **

SIZE	1/4-20		5/16-18		3/8-16		7/16-14 **		1/2-13 **		5/8-11 **	
LENGTH	PART#	\$	PART#	\$	PART#	\$	PART#	\$	PART#	\$	PART#	\$
3/8	2-0536	.18	2-5513	.29								
1/2	2-0537	.19	2-0555	.32	2-0563	.49						
5/8	2-0538	.20	2-0556	.34	2-0564	.53						
3/4	2-0539	.22	2-0557	.39	2-0565	.56						
7/8	2-0540	.24										
1	2-0541	.24	2-0559	.45	2-0567	.65	2-0491	2.69	2-0572	1.49		
1 1/4	2-0542	.29	2-0560	.52	2-0568	.69	2-0492	2.79	2-0573	1.69		
1 1/2	2-0543	.31	2-0561	.58	2-0569	.78	2-0493	2.89	2-0574	1.86	2-0479	6.99
1 3/4	2-0554	.39	2-0595	.69	2-0571	.90						
2	2-0544	.43	2-0562	.78	2-0570	1.09			2-0575	2.40		
2 1/4	2-0549	.59	2-0478	.99	2-0498	1.19						
2 1/2	2-0598	.67	2-0589	1.09	2-0596	1.49			2-0576	3.74		
2 3/4	2-5501	.79	2-5507	1.15	2-0577	1.69						
3	2-0599	.90	2-0592	1.19	2-0597	1.90			2-0499	4.85		
3 1/4			2-5521	2.95								
3 1/2	2-0496	1.50	2-0558	1.57	2-0591	2.90						
3 3/4					2-5527	4.90						
4	2-0494	1.99	2-0566	1.95	2-0593	3.60			2-0581	6.70		
4 1/2	2-5502	2.46	2-5508	2.70	2-5514	10.40						
5	2-5504	2.76	2-5510	3.30	2-0488	12.98			2-5518	18.80		
6	2-5506	3.33	2-5512	4.10	2-5516	15.60						

BUTTON HEAD SHOP ASSORTMENT: 625 PIECES # 3-3003 \$ 250.50
PERSONAL ASSORTMENT: 500 PIECES 3-3150 122.60

TRUSS SOCKET MACHINE SCREWS

*BUTTON HEADS WITH BIGGER HEADS! GREAT FOR HANGING REAR FENDERS ON STEPSIDE TRUCKS!

SIZE:	12-24		1/4-20		5/16-18	
HEAD DIAMETER	.50		.57		.64	
LENGTH	PART#	\$	PART#	\$	PART#	\$
1/2	2-3076	.39	2-3137	.49		
5/8			2-3350	.52		
3/4	2-3103	.44	2-3185	.54	2-3195	.86
1	2-3116	.49	2-3191	.59	2-3196	.93
1 1/4					2-3327	.99

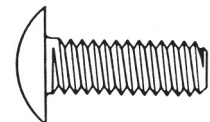
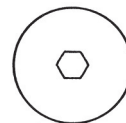

TOLL FREE ORDER LINE : 1-800-767-4781

BUTTON HEAD CAP SCREWS

-SMALL SIZES AND FINE THREAD - LOW STRENGTH-

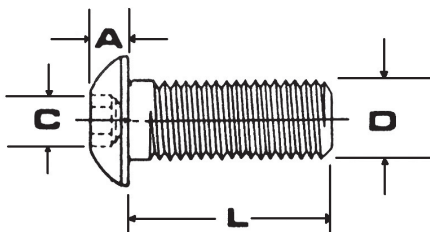
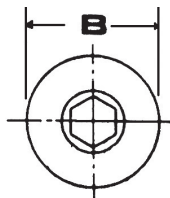

DIMENSION TABLE (INCHES)

D	DIAMETER		.112	.138	.164	.190	.190	1/4	5/16	3/8	1/2
A	HEAD HT.		.055	.07	.08	.10	.10	.13	.16	.19	.26
B	HEAD DIA.		.21	.26	.31	.36	.36	.44	.55	.66	.87
C	KEY SIZE		1/16	5/64	3/32	1/8	1/8	5/32	3/16	7/32	5/16
	ISO #	2	4	6	8	10	10				
	THREADS/INCH	56	40	32	32	24	32	28	24	24	20

PART NUMBER AND PRICE GUIDE

SIZE	2-56		4-40		6-32		8-32		10-24		10-32	
LENGTH	PART#	\$	PART#	\$	PART#	\$	PART#	\$	PART#	\$	PART#	\$
3/16	2-0480	.06										
1/4	2-5500	.07	2-0500	.05	2-0506	.05	2-0512	.06	2-0518	.10	2-0527	.12
5/16			2-5528	.09			2-5540	.07				
3/8			2-0501	.06	2-0507	.06	2-0513	.08	2-0519	.11	2-0528	.11
1/2			2-0502	.07	2-0508	.07	2-0514	.09	2-0520	.12	2-0529	.18
5/8			2-0503	.08	2-0509	.08	2-0515	.10	2-0521	.13	2-0530	.19
3/4			2-0504	.09	2-0510	.09	2-0516	.11	2-0522	.14	2-0531	.20
1			2-0505	.12	2-0511	.10	2-0517	.15	2-0523	.16	2-0532	.22
1 1/4					2-0476	.14	2-0477	.18	2-0524	.20	2-0533	.24
1 1/2					2-0490	.19	2-0497	.21	2-0525	.23	2-0534	.26
2							2-0553	.29	2-0526	.36	2-0535	.40
2 1/2									2-0495	.59		

PART NUMBER AND PRICE GUIDE

SIZE	1/4-28		5/16-24		3/8-24		1/2-20 **	
LENGTH	PART#	\$	PART#	\$	PART#	\$	PART#	\$
3/8	2-0545	.27	2-5541	.54				
1/2	2-0546	.29	2-0587	.59				
5/8	2-0547	.32	2-0586	.64				
3/4	2-0548	.33	2-0580	.69	2-0579	1.49		
7/8								
1	2-0550	.42	2-0582	.79	2-0594	1.58	2-0481	2.95
1 1/4	2-0551	.42	2-0583	.99	2-0578	1.76	2-0482	3.30
1 1/2	2-0552	.49	2-0584	1.19	2-0588	1.88	2-0483	3.70
1 3/4								
2			2-0485	1.49				

NEW SIZES:

5-40 X 1/2 # 2-5532 \$.09
 5-40 X 5/8 # 2-5533 \$.09

**** SPECIFY APPLICATION ON ALL 7/16" AND LARGER SIZES ****

FINE THREAD BUTTON HEAD SHOP ASSORTMENT: 625 PIECES # 3-3042 \$ 355.50
 PERSONAL SIZE ASSORTMENT: 400 PIECES 3-3185 125.00

SIZE:	#8 AB THREAD		#10 AB THREAD		#14 A THREAD	
LENGTH	PART#	\$	PART#	\$	PART#	\$
3/8	2-1970	.18				
1/2	2-1971	.19	2-1981	.29		
5/8	2-1973	.20	2-1982	.31	2-1990	.39
3/4	2-1974	.21	2-1984	.34	2-1991	.44
1	2-1976	.22	2-1986	.39	2-1992	.49

BUTTON HEAD SHEET METAL SCREWS

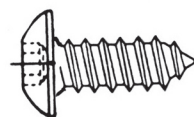
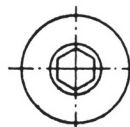

FLAT SOCKET HEAD CAP SCREWS

- LOW STRENGTH -

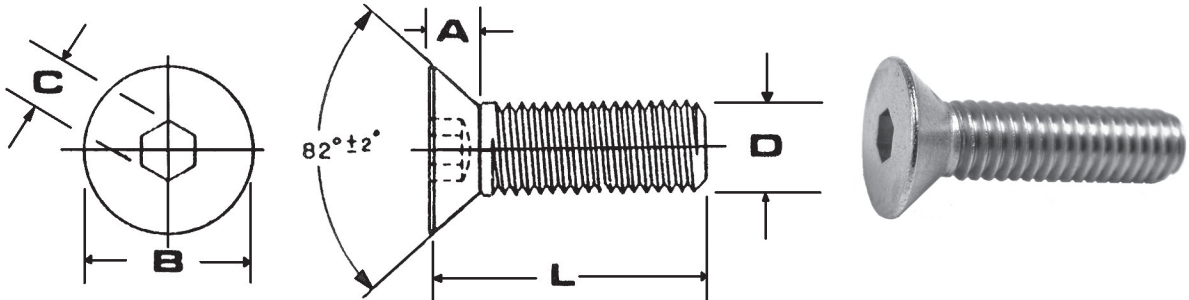

DIMENSION TABLE (INCHES)

D	DIAMETER	.112	.138	.164	.190	.190	.220	1/4	1/4	5/16	5/16	3/8	1/2
A	HEAD HT.	.08	.10	.11	.12	.12	.14	.16	.16	.19	.19	.23	.25
B	HEAD DIA.	.25	.30	.32	.38	.38	.42	.49	.49	.61	.61	.72	.88
C	KEY SIZE	1/16	5/64	3/32	1/8	1/8	1/8	5/32	5/32	3/16	3/16	7/32	5/16
	ISO #	4	6	8	10	10	12						
	THREADS/INCH	40	32	32	24	32	24	20	28	18	24	16	13

PART NUMBER AND PRICE GUIDE

** SPECIFY APPLICATION ON ALL 7/16" AND LARGER SIZES **

SIZE	1/4-20		5/16-18		3/8-16		1/2-13 **	
LENGTH	PART#	\$	PART#	\$	PART#	\$	PART#	\$
3/8	2-6610	.18						
1/2	2-0640	.19	2-0656	.34	2-6612	.68		
5/8	2-0641	.22	2-0657	.37	2-0667	.69		
3/4	2-0642	.24	2-0658	.39	2-0668	.70		
7/8	2-0654	.25						
1	2-0643	.27	2-0659	.46	2-0669	.76	2-0677	1.90
1 1/4	2-0644	.30	2-0660	.59	2-0670	.82	2-0678	2.45
1 1/2	2-0645	.36	2-0661	.65	2-0671	.95	2-0679	2.49
1 3/4	2-0646	.39	2-0662	.76	2-0672	1.19	2-0680	2.80
2	2-0647	.45	2-0663	.79	2-0673	1.29	2-5633	3.20
2 1/2	2-0684	.58	2-0655	.83	2-0674	1.59	2-5634	3.70
3	2-0693	.79	2-0685	.99	2-0675	1.85	2-5635	4.60
3 1/2	2-0683	.98	2-5630	1.54	2-5632	2.98	2-5636	5.40
4	2-0611	1.49	2-0687	1.89	2-0676	3.48	2-0681	5.90
4 1/2	2-5637	6.20	2-5665	6.40	2-5668	6.90	2-5638	9.90
5	2-0639	6.70	2-5667	8.90	2-5669	10.30	2-5639	11.30

ADDITIONAL SIZE:
5/8-11 X 2 #2-6613 \$5.80

WE WILL TURN
DOWN THE HEADS
ON ANY OF OUR
STOCK FLAT
SOCKETS TO MAKE
JACKSON HEAD
SCREWS - IF YOUR
SIZE ISN'T LISTED
- JUST GIVE US
A CALL AT 800-767-
4781

SPECIAL JACKSON HEAD:

5/16-18 X 7/8 WITH A .47 OD
HEAD: 2-5664 \$3.99

CUSTOM MADE HIGH STRENGTH FLAT SOCKETS:
MADE IN OUR SHOP FROM 17-4 PH HEAT TREATED (H-925)
BAR STOCK - STRONGER AND MORE DUCTILE THAN GRADE 8
STEEL

1/4-20 X 1	2-5650	\$16.00
5/16-18 X 1 1/4	2-5660	16.75
3/8-24 X 2 1/4	2-5629	19.80
7/16-14 X 1 1/4	2-0682	17.90
7/16-14 X 2	2-5612	19.90
1/2-20 X 1 3/4	2-5682	20.90

WE CAN MAKE THESE TO ORDER IN ANY SIZE FROM 12-24
(6MM)THRU 9/16 (14MM) - COARSE OR FINE THREAD

PART NUMBER AND PRICE GUIDE UNDERSIZED (JACKSON) HEAD

SIZE	1/4-20		5/16-18	
HEAD DIAMETER	.42 (#12)		.49 (1/4)	
LENGTH	PART#	\$	PART#	\$
5/8	2-5641	1.89	2-5656	2.08
3/4	2-5642	1.92	2-5657	2.17
1	2-5643	1.95	2-5658	2.27
1 1/4	2-5644	1.99	2-5659	2.36
1 1/2	2-5645	1.99	2-5661	2.45
2	2-5646	2.05	2-5662	2.69

FLAT SOCKET CAP SCREW SHOP ASSORTMENT: 635 PIECES # 3-3020 \$ 222.40
PERSONAL ASSORTMENT: 500 PIECES 3-3155 132.50

FLAT SOCKET HEAD CAP SCREWS

-SMALL SIZES AND FINE THREAD - LOW STRENGTH-

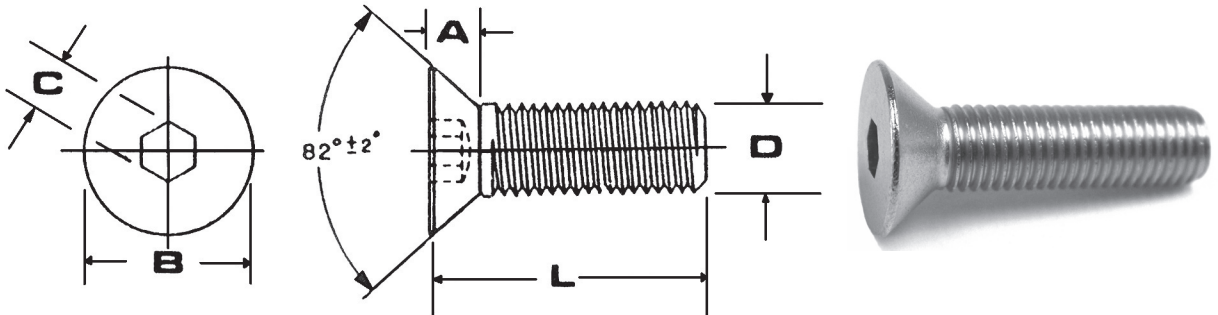

DIMENSION TABLE (INCHES)

D	DIAMETER	.112	.138	.164	.190	.190	.220	1/4	5/16	3/8
A	HEAD HT.	.08	.10	.11	.12	.12	.14	.16	.19	.23
B	HEAD DIA.	.25	.30	.32	.38	.38	.42	.49	.61	.72
C	KEY SIZE	1/16	5/64	3/32	1/8	1/8	1/8	5/32	3/16	7/32
ISO #		4	6	8	10	10	12			
THREADS/INCH		40	32	32	24	32	24	28	24	24

PART NUMBER AND PRICE GUIDE

SIZE	4-40		6-32		8-32		10-24		10-32		12-24		1/4-28	
LENGTH	PART#	\$	PART#	\$	PART#	\$	PART#	\$	PART#	\$	PART#	\$	PART#	\$
1/4	2-6601	.06	2-6605	.07	2-6609	.08								
5/16	2-6602	.06												
3/8	2-0600	.06	2-0606	.07	2-0613	.08	2-0620	.09	2-0627	.09				
1/2	2-0601	.09	2-0607	.09	2-0614	.09	2-0621	.10	2-0628	.10	2-0636	.25	2-0648	.24
5/8	2-0602	.11	2-0608	.11	2-0615	.11	2-0622	.11	2-0629	.11	2-0634	.28	2-0649	.26
3/4	2-0603	.12	2-0609	.12	2-0616	.12	2-0623	.14	2-0630	.14	2-0635	.32	2-0650	.27
1	2-0604	.15	2-0610	.13	2-0617	.13	2-0624	.19	2-0631	.19	2-0637	.35	2-0651	.30
1 1/4					2-0618	.19	2-0625	.21	2-0632	.21			2-0652	.42
1 1/2					2-0619	.21	2-0626	.23	2-0633	.23			2-0653	.54
2					2-0689	.39	2-0690	.39	2-0691	.39			2-0697	1.29

ADDITIONAL SIZES: 5-40 X 1/2 2-6633 .08
 BLACK FLAT SOCKET HEAD: 10-32 X 5/8 2-6672 .27
 10-32 X 3/4 2-6673 .29

PART NUMBER AND PRICE GUIDE UNDERSIZED (JACKSON) HEAD

SIZE	1/4-28		5/16-24		5/16-24	
HEAD DIAMETER	.42 (#12)		.42 (#12)		.49 (1/4)	
LENGTH	PART#	\$	PART#	\$	PART#	\$
1/2	2-5670	1.37	2-5686	1.93		
5/8	2-5671	1.39	2-5685	3.98		
3/4	2-5672	1.40	2-5687	1.99	2-5694	1.84
1	2-5673	1.43	2-5688	2.19	2-6611	1.99
1 1/4	2-5674	1.55	2-5689	2.44	2-0612	2.29
1 1/2	2-5675	1.67	2-5690	2.84	2-5695	2.69
2	2-5677	2.42	2-5691	3.29	2-5696	3.14

5/16-24 WITH THE EXTRA SMALL (.42 DIA) HEADS ARE USED ON EARLY 1930'S DOOR HINGES

5/16-24 WITH THE (.49 DIA) HEADS ARE FOUND ON 1950'S DOOR STRIKERS

PART NUMBER AND PRICE GUIDE STANDARD HEAD SIZE

** SPECIFY APPLICATION ON ALL 7/16" AND LARGER SIZES **

SIZE	5/16-24		3/8-24		1/2-20 **	
LENGTH	PART#	\$	PART#	\$	PART#	\$
1/2	2-0686	.63				
5/8	2-5663	2.69				
3/4	2-0665	.69	2-0692	.99		
1	2-0664	.89	2-0694	1.38		
1 1/4	2-0666	1.14	2-0695	1.63		
1 1/2	2-0688	1.54	2-0696	1.75		
2	2-0698	1.99			2-0699	3.48

WE WILL TURN THE HEADS DOWN ON ANY OF OUR STOCK FLAT SOCKETS TO MAKE JACKSON HEAD SCREWS - IF YOUR SIZE ISN'T LISTED - JUST GIVE US A CALL AT 800-767-4781

FINE THREAD FLAT SOCKET SHOP ASSORTMENT: 665 PIECES # 3-3041 \$ 345.95
 PERSONAL ASSORTMENT: 400 PIECES 3-3182 126.00

HEX HEAD CAP SCREWS

-COARSE US THREADS - LOW STRENGTH-

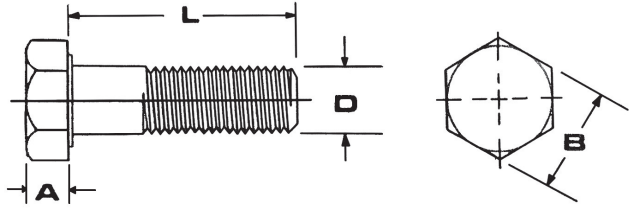
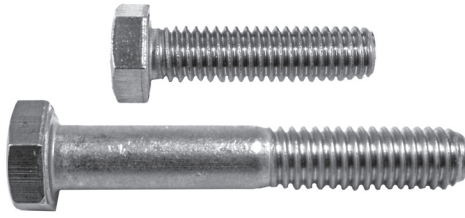

DIMENSION TABLE (INCHES)

D	DIAMETER	1/4	5/16	3/8	7/16	1/2	9/16	5/8	3/4
A	HEAD HT.	.156	.203	.234	.281	.313	.375	.391	.453
B	WRENCH	7/16	1/2	9/16	5/8	3/4	13/16	15/16	1 1/8
THREADS/INCH		20	18	16	14	13	12	11	10

PART NUMBER AND PRICE GUIDE

**** SPECIFY APPLICATION ON ALL 7/16" AND LARGER SIZES ****

SIZE:	1/4-20		5/16-18		3/8-16		7/16-14**		1/2-13**		9/16-12**		5/8-11**		3/4-10**	
LENGTH	PART#	\$	PART#	\$	PART#	\$	PART#	\$	PART#	\$	PART #	\$	PART#	\$	PART#	\$
3/8	2-0100	.24	2-0013	.39	2-0221	.49										
1/2	2-0101	.29	2-0120	.41	2-0139	.55										
5/8	2-0102	.31	2-0121	.42	2-0140	.59										
3/4	2-0103	.32	2-0122	.46	2-0141	.66	2-0160	.99	2-0174	1.19						
7/8	2-0104	.35	2-0123	.51	2-0142	.69			2-0175	1.39						
1	2-0105	.36	2-0124	.54	2-0143	.74	2-0161	1.17	2-0176	1.52			2-0194	3.43		
1 1/4	2-0106	.42	2-0125	.59	2-0144	.81	2-0162	1.28	2-0177	1.66	2-3402	3.50	2-0195	3.64	2-0242	4.95
1 1/2	2-0107	.49	2-0126	.62	2-0145	.94	2-0163	1.39	2-0178	1.89	2-3403	3.90	2-0196	3.75	2-0241	5.20
1 3/4	2-0108	.52	2-0127	.68	2-0146	.99	2-0164	1.54	2-0179	2.03	2-0249	4.40	2-0197	3.87	2-0243	5.40
2	2-0109	.55	2-0128	.72	2-0147	1.14	2-0165	1.69	2-0180	2.14	2-0359	4.90	2-0198	4.12	2-3408	5.60
2 1/4	2-0110	.59	2-0129	.88	2-0148	1.32	2-0166	1.95	2-0181	2.25			2-0199	4.26	2-3400	5.90
2 1/2	2-0111	.69	2-0130	.96	2-0149	1.44	2-0167	2.18	2-0182	2.29	2-3429	5.20	2-0200	4.60	2-0244	6.20
2 3/4	2-0112	.75	2-0131	1.19	2-0150	1.54	2-0168	2.27	2-0183	2.57			2-0201	4.72		
3	2-0113	.79	2-0132	1.24	2-0151	1.59	2-0169	2.35	2-0184	2.68	2-0247	5.50	2-0202	4.78	2-0248	6.90
3 1/4	2-0114	.82	2-0133	1.29	2-0152	1.77	2-0214	2.45	2-0185	2.80			2-0203	4.89		
3 1/2	2-0115	.83	2-0134	1.39	2-0153	1.98	2-0170	2.54	2-0186	2.95			2-0204	4.98	2-0245	7.30
3 3/4	2-0116	.87	2-0135	1.59	2-0154	2.19			2-0187	3.35			2-0205	5.50		
4	2-0117	.89	2-0136	1.68	2-0155	2.25	2-0171	2.60	2-0189	3.88	2-0225	5.95	2-0206	5.60	2-0078	7.60
4 1/4					2-3438	2.39										
4 1/2	2-0118	.96	2-0137	1.77	2-0156	2.48	2-0220	2.90	2-0190	4.96			2-0207	5.79		
4 3/4					2-3433	2.66			2-3434	4.98						
5	2-0119	.98	2-0138	1.86	2-0157	2.79	2-0172	2.96	2-0191	5.19	2-0226	10.85	2-0208	5.96	2-0094	7.90
5 1/2	2-3413	1.59	2-0229	1.99	2-0158	2.88	2-0222	3.80	2-0192	5.48			2-0209	6.47		
6			2-0223	2.07	2-0159	2.97	2-0173	4.30	2-0193	5.62	2-0095	11.90	2-0210	6.60		
6 1/2					2-0219	3.10			2-3416	5.75			2-0228	6.77		
7			2-0188	5.80	2-0211	3.86			2-0224	5.80			2-0227	7.21		
7 1/2					2-3407	3.99			2-0218	5.99			2-0216	7.65		
8			2-3405	6.10	2-3410	4.50			2-3411	6.60					2-0076	9.85
8 1/2			2-3432	8.98												
9					2-0212	4.95			2-0246	6.90			2-0213	7.90		
10					2-0268	5.40			2-0240	7.00						
13													2-3435	12.90		

HEX TAP BOLTS - FULLY THREADED:

- 5/16-18 X 2 # 2-3406 \$.79
- 3/8-16 X 2 2-0074 .98
- 3/8-16 X 3 2-0215 1.25
- 3/8-16 X 3 1/2 2-3401 1.79
- 3/8-16 X 4 2-3437 1.98

HEX HEAD COARSE THREAD ASSORTMENTS:

SHOP: 635 PIECES # 3-3002 \$ 289.95
PERSONAL: 500 PIECES 3-3151 169.00

HEX HEAD CAP SCREWS

-SMALL SIZES AND FINE THREAD - LOW STRENGTH-

DIMENSION TABLE (INCHES)

D	DIAMETER	.112	.138	.164	.190	.216	1/4	5/16	3/8	7/16	1/2	5/8
A	HEAD HT.	.055	.086	.103	.112	.147	.156	.203	.234	.281	.313	.391
C	WRENCH	3/16	1/4	1/4	5/16	5/16	7/16	1/2	9/16	5/8	3/4	15/16
ISO #		4	6	8	10	12						
THREADS/INCH		40	32	32	24/32	24	28	24	24	20	20	18

- MAY BE HEX OR INDENTED HEX - PART NUMBER AND PRICE GUIDE -

ISO #	4-40		6-32		8-32		10-24		10-32		12-24	
LENGTH	PART#	\$	PART#	\$	PART#	\$	PART#	\$	PART#	\$	PART#	\$
1/4	2-0262	.09	2-0255	.09	2-0297	.13			2-0279	.23		
5/16	2-0251	.09	2-0256	.09					2-0280	.24		
3/8	2-0252	.09	2-0257	.09	2-0264	.13	2-0272	.24	2-0281	.24		
1/2	2-0253	.09	2-0258	.11	2-0265	.13	2-0273	.24	2-0282	.24	2-0289	.39
5/8	2-0254	.09	2-0259	.12	2-0266	.13	2-0274	.25	2-0283	.27		
3/4	2-0295	.09	2-0260	.14	2-0267	.15	2-0275	.27	2-0284	.27		
7/8			2-3423	.18					2-0285	.29		
1			2-0261	.20	2-0269	.18	2-0277	.33	2-0286	.33	2-0293	.49
1 1/4					2-0270	.19	2-0278	.36	2-0287	.36		
1 1/2			2-0276	.20	2-0271	.21	2-0292	.39	2-0288	.39		
1 3/4							2-0298	.48	2-3409	.49		
2							2-0299	.64	2-0250	.67		
2 1/2							2-0296	.69	2-3450	.77		
3							2-3424	.78	2-0294	.89		

PART NUMBER AND PRICE GUIDE

** SPECIFY APPLICATION ON ALL 7/16" AND LARGER SIZES **

SIZE:	1/4-28		5/16-24		3/8-24		7/16-20**		1/2-20**		9/16-18**		5/8-18**	
LENGTH	PART#	\$	PART#	\$	PART#	\$	PART#	\$	PART#	\$			PART#	\$
3/8	2-0001	.25												
1/2	2-0002	.29	2-0015	.43	2-0028	.69								
5/8	2-0003	.32	2-0016	.45	2-0029	.74								
3/4	2-0004	.34	2-0017	.49	2-0030	.79	2-3481	1.38	2-0053	1.59				
7/8	2-0005	.36	2-3475	.55										
1	2-0006	.38	2-0019	.59	2-0032	.83	2-0044	1.49	2-0055	1.78			2-0065	4.88
1 1/4	2-0007	.44	2-0020	.69	2-0033	.92	2-0045	1.65	2-0056	1.99	2-0089	11.10	2-0066	5.07
1 1/2	2-0008	.49	2-0021	.78	2-0034	.99	2-0046	1.86	2-0057	2.09			2-0067	5.15
1 3/4	2-0009	.54	2-0022	.89	2-0035	1.06	2-0047	1.97	2-0058	2.19			2-0068	5.28
2	2-0010	.57	2-0023	.95	2-0036	1.19	2-0048	2.03	2-0059	2.39	2-0084	10.85	2-0069	5.39
2 1/4	2-0011	.62	2-0024	1.09	2-0037	1.38	2-0049	2.27	2-0060	2.64			2-3489	5.98
2 1/2	2-0012	.59	2-0025	1.19	2-0038	1.59	2-0050	2.36	2-0061	2.85			2-0086	6.60
2 3/4			2-0026	1.26	2-0039	1.74	2-3482	2.48	2-3485	2.99				
3	2-0014	.79	2-0027	1.29	2-0040	1.85	2-0052	2.59	2-0063	3.25			2-0087	7.20
3 1/4			2-0070	1.44					2-3486	3.36				
3 1/2	2-3470	.86	2-0073	1.59	2-0042	1.99	2-0368	2.98	2-0064	3.49			2-0075	7.90
4	2-0051	.98	2-3415	1.78	2-0043	2.35	2-3414	3.40	2-0062	3.98			2-0079	8.30
4 1/2			2-0077	1.97	2-0085	2.98	2-0366	3.80	2-3487	4.74			2-0031	8.30
5			2-3476	2.23	2-3478	3.49			2-0018	5.38			2-0041	8.89
6			2-3477	2.49										

5/16-24 X 1 1/2 HEX TAP BOLT - FULLY THREADED # 2-0000 \$ 0.59

5/16-24 X 2 1/2 HEX TAP BOLT - FULLY THREADED # 2-0054 \$ 1.29

HEX HEAD FINE THREAD SHOP ASSORTMENT: 635 PIECES # 3-3018 \$ 306.95
PERSONAL ASSORTMENT: 400 PIECES 3-3186 179.00

BLACK ORIGINAL STYLE STAINLESS FASTENERS

THESE ORIGINAL STYLE FASTENERS ARE REPRODUCED IN STAINLESS AND TREATED TO A PERMANENT BLACK FINISH. THIS EXCLUSIVE STAINLESS PRODUCT IS MADE FOR CUSTOMERS WHO WANT THE RESTORED LOOK WITHOUT THE RUST!

BLACK INDENTED HEX - NO FLANGE - MADE IN USA!										
	1/4-20		1/4-20		5/16-18		5/16-24		3/8-16	
	3/8 WRENCH		7/16 WRENCH		1/2 WRENCH		1/2 WRENCH		9/16 WRENCH	
LENGTH	PART#	\$	PART#	\$	PART#	\$	PART#	\$	PART#	\$
1/2			2-1861	1.84						
5/8	2-1860	1.76	2-1862	1.87	2-1850	2.05	2-1895	2.07		
3/4			2-1863	1.89	2-1851	2.09	2-1896	2.09	2-1853	2.49
1	2-1883	1.85			2-1852	2.19	2-1897	2.19	2-1854	2.54
1 1/4									2-1855	2.57
1 1/2									2-1886	2.59

BLACK INDENTED HEX WASHER HEAD				
	1/4-20 .50 OD FLANGE		5/16-18 .68 OD FLANGE	
LENGTH	PART#	\$	PART #	\$
1/2	2-1937	3.75	2-1856	3.97
5/8	2-1938	3.77	2-1857	4.15
3/4	2-1939	3.79	2-1858	4.20
1			2-1859	4.25

WITH 13/16 OD BIG FLANGE HEAD:
 5/16-18 X 3/4 # 2-1894 \$ 4.54
 5/16-24 X 3/4 2-1893 4.54



1/4-20 BLACK SERRATED FLANGE NUT # 2-1955 \$.59
 5/16-18 BLACK SERRATED FLANGE NUT 2-1864 .69
 5/16-24 BLACK SERRATED FLANGE NUT 2-1967 .83

BLACK MACHINE SCREWS				
SIZE	LENGTH	DESCRIPTION	PART#	\$
10-24	3/4	HEX MACHINE SCREW	2-1956	.65
10-24	1/2	PHILLIPS FLAT HEAD	2-1952	.58
8-32	3/4	PHILLIPS PAN HEAD	2-1957	.59
10-24	5/8	PHILLIPS PAN HEAD	2-1954	.62
10-32	3/8	PHILLIPS PAN HEAD	2-1958	.59
1/4-20	1/2	PHILLIPS PAN HEAD	2-1953	.69
1/4-20	5/8	PHILLIPS ROUND	2-1951	.69
8-32	3/4	PHIL OVAL JACKSON	2-1959	.79
1/4-20	7/8	PHIL OVAL JACKSON	2-1950	1.15
8-32	1/2	PHILLIPS TRUSS	2-1960	.66
10-24	1/2	PHILLIPS TRUSS	2-1961	.67
5/16-18	3/4	PHILLIPS TRUSS	2-1962	1.05

BLACK SHEET METAL SCREWS				
SIZE	LENGTH	DESCRIPTION	PART#	\$
#8	1/2	INDENTED HEX	2-1944	.63
#8	5/8	INDENTED HEX	2-1839	.70
#10	5/8	INDENTED HEX	2-1891	.74
#14	3/4	HEX - 7/16 HEAD	2-1867	1.15
5/16	3/4	INDENTED HEX WASHER	2-1963	1.64
5/16	1	INDENTED HEX	2-1890	1.64
#10	1/2	HEX WASHER - AB	2-1946	.91
#10	3/4	HEX WASHER - AB	2-1945	.93
#14	5/8	HEX WASHER - AB	2-1845	1.39
#8	1/2	PHIL OVAL JACKSON	2-1872	.74
#8	3/4	PHIL OVAL JACKSON	2-1865	.76
#8	1	PHIL OVAL JACKSON	2-1866	.79
#8	1 1/4	PHIL OVAL JACKSON	2-1968	.84
#10	5/8	PHIL OVAL JACKSON	2-1880	.89
#10	3/4	PHIL OVAL JACKSON	2-1884	.91
#10	1	PHIL OVAL JACKSON	2-1885	.94
#6	3/8	PHILLIPS PAN	2-1846	.64
#8	3/8	PHILLIPS PAN	2-1879	.66
#8	1/2	PHILLIPS PAN	2-1868	.67
#8	5/8	PHILLIPS PAN	2-1882	.68
#8	3/4	PHILLIPS PAN	2-1869	.69
#8	1	PHILLIPS PAN	2-1870	.70
#10	5/8	PHILLIPS PAN	2-1871	.67
#10	1	PHILLIPS PAN	2-1940	.74
#14	5/8	PHILLIPS PAN	2-1892	.73
#10	1/2	PHILLIPS ROUND	2-1847	.68
#8	1/2	PHIL ROUND WASHER	2-1888	.69
#8	3/8	PHILLIPS TRUSS	2-1900	.63
#8	1/2	PHILLIPS TRUSS	2-1873	.64
#8	1	PHILLIPS TRUSS	2-1877	.67
#10	1/2	PHILLIPS TRUSS	2-1878	.68
#10	3/4	PHILLIPS TRUSS	2-1881	.69
#8	3/8	PHIL TRUSS JACKSON	2-1898	.68
#8	1/2	PHIL TRUSS JACKSON	2-1899	.70

BLACK WASHERS					
SIZE	O.D.	DESCRIPTION	T	PART#	\$
#6	3/6	MS805	.03	2-1919	.45
# 6	.625	#6 FENDER	.03	2-1844	.58
#6 C SK	.3125	#6 COUNTERSUNK	.03	2-1876	.61
# 8	.465	4 MM LARGE	.037	2-4284	.57
# 10	.4386	# 10 AN	.06	2-4258	.55
1/4	.50	1/4 AN	.06	2-4412	.59
1/4	.625	MS810	.062	2-4294	.59
1/4	.63	1/4 STANDARD	.04	2-4414	.59
1/4	.70	6 MM LARGE	.055	2-4298	.67
1/4	.75	1/4 HEAVY	.07	2-4295	.82
5/16	.73	MS811	.055	2-4290	.64
5/16	.85	5/16 HEAVY	.085	2-4296	.92
5/16	.935	8 MM LARGE	.075	2-4297	.87
5/16	1.25	5/16 FENDER	.060	2-4413	.86
3/8	.78	10MM STANDARD	.075	2-4291	.73
3/8	.875	MS813	.075	2-4411	.68
3/8	.99	3/8 HINGE	.115	2-4292	1.28
3/8	1.17	10 MM LARGE	.09	2-4293	1.10

US INDENTED HEX CAP SCREWS

- ORIGINAL STYLE FASTENERS IN STAINLESS! - USED ON CARS AND TRUCKS FROM 1950-1980 -

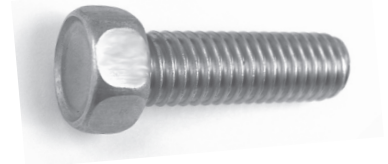
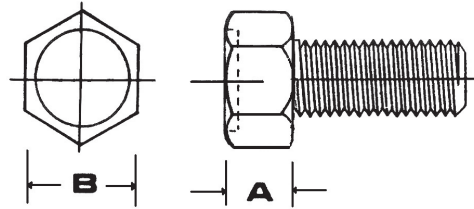

DIMENSION TABLE (INCHES)

D	DIAMETER	1/4	1/4	5/16	5/16	3/8	3/8
B	WRENCH	3/8	7/16	1/2	1/2	9/16	9/16
	THREADS/INCH	20	20	18	24	16	24

PART NUMBER AND PRICE GUIDE

SIZE:	1/4-20		1/4-20		5/16-18		5/16-24		3/8-16		3/8-24	
	3/8 WRENCH		7/16 WRENCH									
LENGTH	PART#	\$	PART#	\$	PART#	\$	PART#	\$	PART#	\$	PART#	\$
1/2	2-0230	2.50	2-0235	2.60			2-0993	2.70				
5/8	2-0231	2.55	2-0236	2.65	2-0090	2.70	2-0994	2.75				
3/4	2-0232	2.60	2-0237	2.70	2-0091	2.75	2-0995	2.80	2-0096	2.85	2-0978	2.90
7/8	2-0239	2.65	2-0238	2.75								
1	2-0233	2.80			2-0092	3.00	2-0996	3.10	2-0097	3.15	2-0998	
1 1/4	2-0234	2.85			2-0099	3.10	2-0997	3.15	2-0098	3.20	2-0999	3.25
1 1/2					2-0980	3.15			2-0093	3.25		
1 3/4					2-0981	3.25			2-0969	3.30		
2					2-0982	3.35			2-0072	3.35		

US INDENTED HEX WASHER HEAD SCREWS

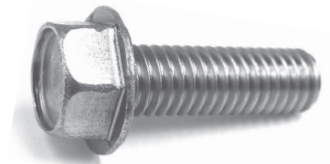
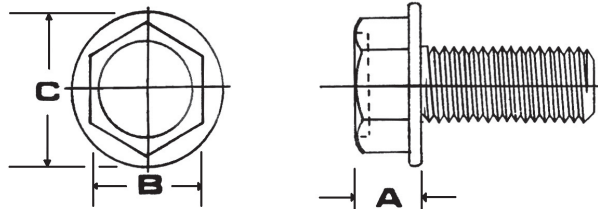

D	DIAMETER	1/4	5/16	5/16	5/16	3/8
C	FLANGE	.50	.64	.813	.813	.781
B	WRENCH	3/8	1/2	1/2	1/2	9/16
	THREADS/INCH	20	18	18	24	16

PART NUMBER AND PRICE GUIDE

SIZE:	10-24		1/4-20		5/16-18		5/16-18		5/16-24		3/8-16	
					11/16 FLANGE		13/16 FLANGE		13/16 FLANGE			
LENGTH	PART#	\$	PART#	\$	PART#	\$	PART#	\$	PART#	\$	PART#	\$
3/8	2-0961	2.65										
1/2	2-0962	2.70	2-0971	2.90	2-0080	3.05						
5/8	2-0963	2.75	2-0972	2.95	2-0081	3.10						
3/4	2-0964	2.80	2-0973	3.00	2-0082	3.15	2-0991	3.50	2-0992	3.55	2-0984	3.65
7/8			2-0974	3.10								
1			2-0975	3.15	2-0083	3.20					2-0985	3.75
1 1/4			2-0976	3.20	2-0989	3.25					2-0986	3.80
1 1/2			2-0977	3.25	2-0983	3.30					2-0987	3.85

SOCKET HEAD CAP SCREWS

US COARSE THREAD - LOW STRENGTH -

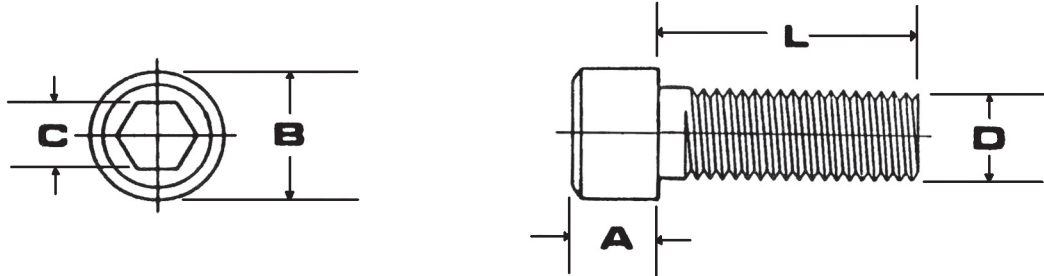

DIMENSION TABLE (INCHES)

D	DIAMETER	1/4	5/16	3/8	7/16	1/2	5/8
A	HEAD HT.	.250	.312	.375	.437	.50	.625
B	HEAD DIA.	.375	.469	.563	.656	.75	.934
C	KEY SIZE	3/16	1/4	5/16	3/8	3/8	1/2
THREADS/INCH		20	18	16	14	13	11



PART NUMBER AND PRICE GUIDE

**** SPECIFY APPLICATION ON ALL 7/16" AND LARGER SIZES ****

SIZE:	1/4-20		5/16-18		3/8-16		7/16-14**		1/2-13**		5/8-11**	
LENGTH	PART#	\$	PART#	\$	PART#	\$	PART#	\$	PART#	\$	PART#	\$
5/16			2-9972	.49								
3/8	2-0300	.23	2-0319	.43								
1/2	2-0301	.29	2-0320	.45	2-0339	.64						
5/8	2-0302	.32	2-0321	.46	2-0340	.69						
3/4	2-0303	.34	2-0322	.48	2-0341	.75	2-0360	1.65	2-0374	1.68		
7/8	2-0304	.36	2-0323	.49	2-0342	.79						
1	2-0305	.39	2-0324	.54	2-0343	.86	2-0361	1.86	2-0376	1.79	2-0394	3.60
1 1/4	2-0306	.44	2-0325	.59	2-0344	.94	2-0362	1.99	2-0377	1.88	2-0395	3.80
1 1/2	2-0307	.49	2-0326	.69	2-0345	.99	2-0363	2.22	2-0378	2.04	2-0396	3.95
1 3/4	2-0308	.54	2-0327	.79	2-0346	1.05	2-0364	2.95	2-0379	2.18	2-0397	4.30
2	2-0309	.59	2-0328	.89	2-0347	1.19	2-0365	3.40	2-0380	2.25	2-0398	4.50
2 1/4	2-0310	.63	2-0329	.98	2-0348	1.29	2-0387	3.95	2-0381	2.55	2-0399	4.70
2 1/2	2-0311	.70	2-0330	1.09	2-0349	1.49	2-0367	4.50	2-0382	2.60	2-0400	4.90
2 3/4	2-0312	.77	2-0331	1.19	2-0350	1.60			2-0383	2.90		
3	2-0313	.85	2-0332	1.28	2-0351	1.90	2-0369	5.39	2-0384	3.32	2-0402	5.40
3 1/4	2-0401	.99	2-0333	1.67	2-0352	2.46						
3 1/2	2-0315	.99	2-0334	2.03	2-0353	2.49	2-0370	5.78	2-0386	4.99	2-0404	7.96
3 3/4			2-0335	2.81	2-0354	3.57						
4	2-0317	1.56	2-0336	3.55	2-0355	3.96	2-0371	7.99	2-0389	5.68	2-0406	9.87
4 1/2	2-0372	3.00	2-0337	3.90	2-0356	4.98			2-0390	6.83		
5	2-0373	3.95	2-0338	4.30	2-0357	5.40			2-0391	7.40	2-0408	11.86
5 1/2			2-3391	4.80	2-3393	5.90			2-0392	8.60		
6			2-0375	6.00	2-0358	6.80			2-0393	9.99	2-0410	19.98
7 1/2									2-0388	11.60		

ADDITIONAL SIZES: 3/4-10 X 3 1/2 SOCKET # 2-0314 \$ 9.60

SOCKET HEAD COARSE THREAD SHOP ASSORTMENT: 635 PIECES # 3-3004 \$ 415.75

PERSONAL ASSORTMENT: 500 PIECES 3-3153 161.50



TOLL FREE ORDER LINE : 1-800-767-4781

SOCKET HEAD CAP SCREWS

- SMALL SIZES & FINE THREAD - LOW STRENGTH -
DIMENSION TABLE (INCHES)

D	DIAMETER	.112	.125	.138	.164	.190	.190	1/4	5/16	3/8	7/16	1/2
A	HEAD HT.	.112	.125	.138	.164	.190	.190	.156	.203	.234	.281	.313
B	HEAD DIA.	.183	.20	.226	.270	.312	.312	.375	.469	.563	.656	.75
C	KEY SIZE	3/32	3/32	7/64	9/64	5/32	5/32	3/16	1/4	5/16	3/8	3/8
ISO #		4	5	6	8	10	10					
THREADS/INCH		40	40	32	32	24	32	28	24	24	20	20

PART NUMBER AND PRICE GUIDE - SMALL SIZES

ISO#	4-40		5-40		6-32		8-32		10-24		10-32	
LENGTH	PART#	\$	PART#	\$	PART#	\$	PART#	\$	PART#	\$	PART#	\$
1/4	2-0900	.07			2-0910	.08	2-0920	.09	2-9970	.25	2-9971	.25
5/16	2-0901	.08			2-0911	.09	2-0921	.11				
3/8	2-0902	.09			2-0912	.10	2-0922	.12	2-0932	.14	2-0944	.14
1/2	2-0903	.10	2-0967	.12	2-0913	.11	2-0923	.13	2-0933	.15	2-0945	.15
5/8	2-0904	.11			2-0914	.12	2-0924	.14	2-0934	.16	2-0946	.16
3/4	2-0905	.12			2-0915	.20	2-0925	.23	2-0935	.24	2-0947	.24
7/8	2-0906	.16			2-0916	.24	2-0926	.25	2-0936	.26	2-0948	.26
1	2-0907	.18			2-0917	.26	2-0927	.27	2-0937	.27	2-0949	.27
1 1/4	2-0908	.23			2-0918	.29	2-0928	.31	2-0938	.31	2-0950	.31
1 1/2	2-0909	.26			2-0919	.35	2-0929	.36	2-0939	.36	2-0951	.36
1 3/4	2-0966	.29			2-0943	.38	2-0930	.49	2-0940	.52	2-0952	.54
2							2-0931	.56	2-0941	.58	2-0953	.62
2 1/4												
2 1/2									2-0942	.76	2-0954	.78
3									2-0965	1.55		



PART NUMBER AND PRICE GUIDE - FINE THREAD

** SPECIFY APPLICATION ON ALL 7/16" AND LARGER SIZES **

SIZE	1/4-28		5/16-24		3/8-24		7/16-20**		1/2-20**	
LENGTH	PART#	\$	PART#	\$	PART#	\$	PART#	\$	PART#	\$
3/8	2-0411	.24								
1/2	2-0412	.29	2-0427	.49	2-0440	.99				
5/8	2-0413	.33	2-0428	.47	2-0441	1.98				
3/4	2-0414	.35	2-0429	.49	2-0442	.74			2-9973	2.49
7/8	2-0415	.37	2-0430	.58						
1	2-0416	.39	2-0431	.63	2-0444	.86	2-0456	3.55	2-0467	1.99
1 1/4	2-0417	.48	2-0432	.64	2-0445	.95	2-0457	4.27	2-0468	2.41
1 1/2	2-0418	.55	2-0433	.74	2-0446	.98	2-0458	4.56	2-0469	2.69
1 3/4	2-0419	.59	2-0434	.87	2-0447	1.40	2-0459	4.82	2-0470	2.85
2	2-0420	.69	2-0435	.91	2-0448	1.45	2-0460	4.98	2-0471	2.99
2 1/4	2-0421	.74	2-0436	1.14	2-0449	1.49				
2 1/2	2-0422	1.19	2-0437	1.21	2-0450	1.96			2-0473	4.33
2 3/4			2-0438	1.35	2-0451	2.35				
3	2-0424	1.28	2-0439	1.49	2-0452	2.59			2-0475	6.47
3 1/2			2-0454	3.95						
4					2-0455	4.90			2-0405	17.15

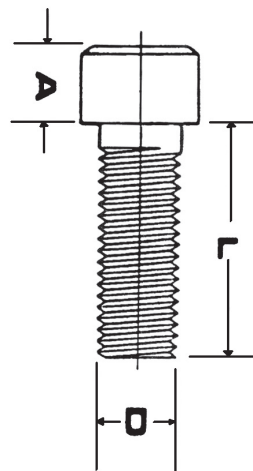

ADDITIONAL SIZES: 5-40 X 1/2 2-0967 .12 12-24 X 1 1/4 # 2-0990 \$ 1.79

* 5/8-18 X 2 #2-0316 \$ 10.71 *3/4-16 X 1 1/2 # 2-0481 \$ 7.90

SOCKET HEAD FINE THREAD SHOP ASSORTMENT: 635 PIECES # 3-3019 \$ 342.50
PERSONAL ASSORTMENT: 400 PIECES 3-3156 159.00

BINDING HEAD MACHINE SCREWS

- SLOTTED HEAD -

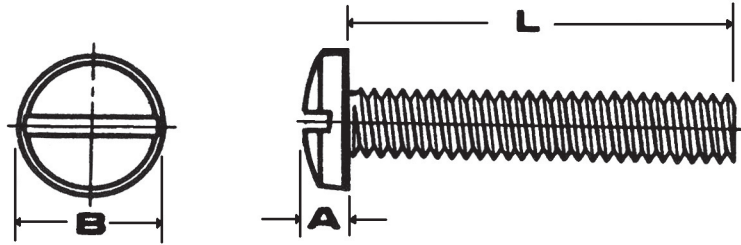

DIMENSION TABLE (INCHES)

D	DIAMETER	.112	.138	.164	.190	.190	.212	1/4
B	HEAD DIA.	.235	.29	.344	.399	.399	.454	.513
A	HEAD HT.	.063	.080	.097	.112	.112	.130	.153
	ISO #	4	6	8	10	10	12	
	THREADS/INCH	40	32	32	24	32	24	20

PART NUMBER AND PRICE GUIDE

SIZE:	4-40		6-32		8-32		10-24		10-32		12-24		1/4-20	
LENGTH	PART#	\$	PART#	\$	PART#	\$	PART#	\$	PART#	\$	PART#	\$	PART#	\$
1/8	2-2000	.08	2-2013	.11										
3/16	2-2001	.07	2-2014	.08										
1/4	2-2002	.07	2-2015	.08	2-2029	.09	2-2042	.09	2-2055	.11				
5/16			2-2016	.08	2-2030	.09								
3/8	2-2004	.08	2-2017	.09	2-2031	.09	2-2044	.10	2-2057	.13				
7/16			2-2018	.09										
1/2	2-2006	.08	2-2019	.09	2-2033	.10	2-2046	.15	2-2059	.15			2-2077	.34
5/8	2-2007	.09	2-2020	.10	2-2034	.11	2-2047	.16	2-2060	.16	2-2070	.32	2-2078	.39
3/4	2-2008	.09	2-2021	.12	2-2035	.14	2-2048	.19	2-2061	.19	2-2071	.36	2-2079	.43
7/8			2-2022	.13										
1	2-2010	.10	2-2023	.16	2-2037	.17	2-2050	.24	2-2063	.24	2-2072	.43	2-2081	.49
1 1/4			2-2024	.20	2-2038	.21	2-2051	.29	2-2064	.29			2-2082	.57
1 1/2			2-2025	.28	2-2039	.29	2-2052	.38	2-2065	.38			2-2083	.65
2			2-2027	.34	2-2041	.45	2-2054	.58	2-2067	.58			2-2085	.98

ADDITIONAL SIZES: 3-48 X 1/4 SLOTTED BINDING # 2-2012 \$.19

1/4-20 X 5/8 PHILLIPS BINDING # 2-2090 \$ 0.26

TOLL FREE ORDER LINE : 1-800-767-4781

FILLISTER HEAD MACHINE SCREWS

- PHILLIPS HEAD -

SIZE:	6-32		8-32		10-24		10-32	
LENGTH	PART#	\$	PART#	\$	PART#	\$	PART#	\$
3/8	2-6111	.14	2-6127	.16	2-6139	.20	2-6151	.20
1/2	2-6112	.15	2-6128	.17	2-6140	.22	2-6152	.22
5/8	2-6113	.16	2-6129	.18	2-6141	.24	2-6153	.24
3/4	2-6114	.17	2-6130	.19	2-6142	.25	2-6154	.25
1			2-6132	.21	2-6144	.29	2-6156	.29

FILLISTER HEAD MACHINE SCREWS

- SLOTTED HEAD -

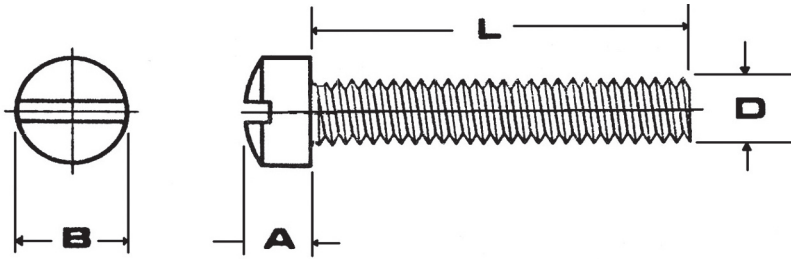

DIMENSION TABLE (INCHES)

D	DIAMETER	.112	.138	.164	.190	.190	.216	1/4	1/4	5/16	3/8
B	HEAD DIA.	.17	.21	.26	.30	.30	.34	.40	.40	.50	.60
A	HEAD HT.	.09	.11	.14	.17	.17	.19	.21	.21	.27	.33
ISO #		4	6	8	10	10	12				
THREADS/INCH		40	32	32	24	32	24	20	28	18	16

PART NUMBER AND PRICE GUIDE

SIZE:	4-40		6-32		8-32		10-24		10-32		12-24		1/4-20	
LENGTH	PART#	\$	PART#	\$	PART#	\$	PART#	\$	PART#	\$	PART#	\$	PART#	\$
1/8	2-2100	.07			2-2126	.26								
1/4	2-2102	.07	2-2113	.09	2-2127	.14	2-2140	.18	2-2153	.18				
5/16	2-2103	.07	2-2114	.09	2-2128	.15	2-2141	.19	2-2154	.19				
3/8	2-2104	.08	2-2115	.10	2-2129	.16	2-2142	.20	2-2155	.20	2-2177	.39	2-2179	.39
7/16	2-2105	.08							2-2156	.21				
1/2	2-2106	.08	2-2117	.10	2-2131	.17	2-2144	.21	2-2157	.20	2-2170	.44	2-2180	.45
5/8	2-2107	.09	2-2118	.10	2-2132	.18	2-2145	.22	2-2158	.22	2-2171	.49	2-2181	.49
3/4	2-2108	.10	2-2119	.13	2-2133	.18	2-2146	.23	2-2159	.23	2-2172	.54	2-2182	.53
7/8			2-2120	.16	2-2134	.19	2-2147	.28	2-2160	.28				
1	2-2110	.13	2-2121	.19	2-2135	.22	2-2148	.29	2-2161	.29	2-2173	.59	2-2184	.57
1 1/4			2-2122	.24	2-2136	.28	2-2149	.38	2-2162	.38			2-2185	.61
1 1/2			2-2123	.26	2-2137	.32	2-2150	.46	2-2163	.46			2-2186	.67
1 3/4					2-2138	.38	2-2151	.57	2-2164	.54			2-2187	.73
2			2-2125	.29	2-2139	.53	2-2152	.69	2-2165	.69			2-2188	.79
2 1/2					2-2190	.98			2-2166	.76			2-2176	.97
3									2-2167	.99				

SIZE:	1/4-28		5/16-18		3/8-16	
LENGTH	PART#	\$	PART#	\$	PART#	\$
1/2	2-2169	.46	2-2101	.49		
5/8	2-2191	.49				
3/4	2-2192	.54	2-2194	.89	2-2196	.99
1	2-2193	.59	2-2195	.94	2-6170	1.19
1 1/4			2-2189	.98		
1 1/2			2-2109	.99	2-2143	1.29
1 3/4			2-2111	.99		
2			2-2112	1.10	2-2168	1.48
2 1/2			2-2124	1.19		
3			2-2130	1.28		

SLOTTED FILLISTER MACHINE SCREW SHOP ASSORTMENT: 1720 PIECES # 3-3055 \$ 302.50
 PERSONAL ASSORTMENT: 850 PIECES 3-3157 143.00

FLAT HEAD MACHINE SCREWS

- PHILLIPS HEAD -

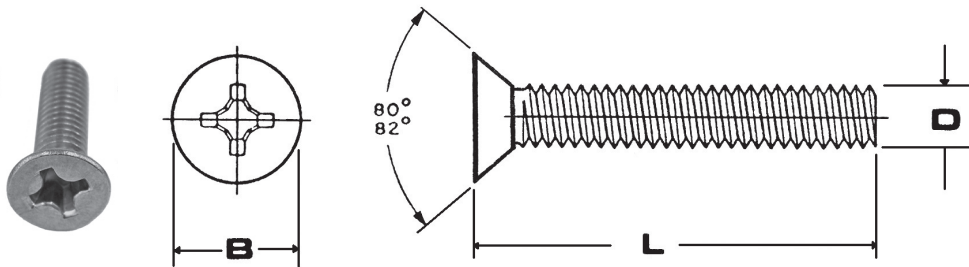

DIMENSION TABLE (INCHES)

D	DIAMETER	.112	.138	.164	.190	.190	.216	1/4	1/4	5/16	3/8
B	HEAD DIA.	.21	.26	.30	.37	.37	.40	.46	.46	.59	.70
ISO #		4	6	8	10	10	12				
THREADS/INCH		40	32	32	24	32	24	20	28	18	16

PART NUMBER AND PRICE GUIDE

SIZE:	4-40		6-32		8-32		10-24		10-32	
LENGTH	PART#	\$	PART#	\$	PART#	\$	PART#	\$	PART#	\$
3/16					2-2438	.04				
1/4	2-2345	.02	2-2350	.03	2-2362	.05	2-2434	.05	2-2368	.06
5/16	2-2340	.02	2-2351	.03	2-2374	.05				
3/8	2-2341	.03	2-2352	.03	2-2364	.05	2-2375	.06	2-2386	.06
1/2	2-2342	.03	2-2353	.04	2-2365	.05	2-2376	.07	2-2387	.08
5/8	2-2343	.04	2-2354	.05	2-2366	.06	2-2377	.08	2-2388	.08
3/4	2-2344	.04	2-2355	.05	2-2367	.07	2-2378	.11	2-2389	.09
7/8			2-2356	.05	2-2316	.08	2-2379	.12	2-2390	.11
1	2-2346	.05	2-2357	.06	2-2369	.08	2-2380	.12	2-2391	.12
1 1/4	2-2347	.06	2-2358	.06	2-2370	.10	2-2381	.14	2-2392	.14
1 1/2			2-2359	.10	2-2371	.11	2-2382	.15	2-2393	.15
1 3/4					2-2372	.13	2-2437	.19	2-2439	.19
2			2-2361	.13	2-2373	.14	2-2384	.26	2-2395	.24
2 1/2					2-2363	.23	2-2383	.34	2-2394	.38
3					2-2372	.29	2-2385	.40	2-2407	.45

PHILLIPS FLAT JACKSON HEAD

- 5/16-24 X 1 # 2-2435 \$.89
- X 1 1/4 2-2432 .95
- X 1 1/2 2-2433 .99



PHILLIPS FLAT MACHINE SCREW SHOP ASSORTMENT: 1720 PIECES

- # 3-3027 \$ 206.00
- PERSONAL ASSORTMENT:
- 850 PIECES 3-3158 125.00

PART NUMBER AND PRICE GUIDE

SIZE:	12-24		1/4-20		1/4-28		5/16-18		5/16-24		3/8-16	
LENGTH	PART#	\$	PART#	\$	PART#	\$	PART#	\$	PART#	\$	PART#	\$
3/8			2-2473	.16								
1/2	2-2396	.16	2-2397	.17	2-2422	.19	2-2416	.29				
5/8	2-2442	.17	2-2398	.18			2-2425	.32				
3/4	2-2360	.18	2-2399	.20	2-2420	.24	2-2410	.35	2-2441	.84		
7/8			2-2400	.21	2-2447	.28					2-2484	.49
1	2-2443	.23	2-2401	.22	2-2408	.39	2-2412	.39			2-2348	.51
1 1/4	2-2444	.24	2-2402	.25	2-2421	.58	2-2413	.48				
1 1/2	2-2445	.35	2-2403	.29	2-2431	.59	2-2414	.56			2-2427	.74
1 3/4	2-2446	.39	2-2404	.32			2-2415	.69			2-2448	.89
2			2-2405	.34	2-2426	.65	2-2417	1.00			2-2449	1.12
2 1/2			2-2409	.35			2-2418	1.18			2-2454	1.29
3			2-2406	.45			2-2419	1.29				
3 1/2			2-2423	.49								
4			2-2411	.54							2-2429	1.44
5							2-2488	2.89				

FLAT HEAD MACHINE SCREWS

- SLOTTED HEAD - DIMENSION TABLE (INCHES)

D	DIAMETER	.086	.112	.138	.164	.190	.190	.216	1/4	1/4	5/16	5/16	3/8	1/2
B	HEAD DIA.	.155	.21	.26	.30	.37	.37	.40	.46	.46	.59	.59	.70	.81
	ISO #	2	4	6	8	10	10	12						
	THREADS/INCH	56	40	32	32	24	32	24	20	28	18	24	16	13

PART NUMBER AND PRICE GUIDE

SIZE:	2-56		4-40		6-32		8-32		10-24		10-32		12-24	
LENGTH	PART#	\$	PART#	\$	PART#	\$	PART#	\$	PART#	\$	PART#	\$	PART#	\$
3/16	2-2247	.04	2-2200	.04	2-2212	.05								
1/4			2-2201	.04	2-2213	.05	2-2226	.09	2-2240	.11	2-2255	.11		
5/16			2-2202	.04	2-2214	.07	2-2227	.09			2-2256	.12		
3/8			2-2203	.04	2-2215	.07	2-2228	.09	2-2242	.13	2-2257	.13	2-2270	.24
7/16			2-2204	.05	2-2216	.08	2-2229	.09	2-2243	.15	2-2258	.15		
1/2			2-2205	.05	2-2217	.08	2-2230	.10	2-2244	.17	2-2259	.17	2-2271	.25
5/8			2-2206	.06	2-2218	.08	2-2231	.12	2-2245	.18	2-2260	.18	2-2272	.27
3/4			2-2207	.06	2-2219	.09	2-2232	.13	2-2246	.19	2-2261	.19	2-2273	.29
7/8			2-2208	.07	2-2220	.10	2-2233	.14	2-2224	.20	2-2262	.20		
1			2-2209	.08	2-2221	.10	2-2234	.15	2-2248	.21	2-2263	.21	2-2275	.32
1 1/4			2-2210	.09	2-2222	.12	2-2235	.17	2-2249	.23	2-2264	.23	2-2276	.34
1 1/2					2-2223	.13	2-2236	.19	2-2250	.25	2-2265	.25	2-2277	.38
1 3/4							2-2237	.21	2-2251	.27	2-2266	.27		
2					2-2225	.16	2-2239	.24	2-2252	.29	2-2267	.29	2-2279	.48
2 1/2							2-2238	.28	2-2253	.35	2-2268	.35	2-2278	.59
3							2-2241	.37	2-2254	.42	2-2269	.42		

PART NUMBER AND PRICE GUIDE

SIZE:	1/4-20		1/4-28		5/16-18		5/16-24		3/8-16		1/2-13	
LENGTH	PART#	\$	PART#	\$	PART#	\$	PART#	\$	PART#	\$	PART#	\$
3/8	2-2280	.19	2-2294	.24								
1/2	2-2281	.21	2-2295	.27	2-2302	.29						
5/8	2-2282	.23	2-2430	.29	2-2303	.33						
3/4	2-2283	.25	2-2297	.32	2-2304	.36	2-2298	.92	2-2317	.49	2-2329	1.69
7/8	2-2284	.27			2-2305	.99						
1	2-2285	.29	2-2299	.33	2-2306	.42	2-2330	.93	2-2319	.57	2-2331	1.79
1 1/4	2-2286	.31	2-2318	.37	2-2307	.46			2-2320	.62	2-2332	1.86
1 1/2	2-2287	.33	2-2337	.39	2-2308	.49			2-2321	.67	2-2333	1.94
1 3/4	2-2288	.35			2-2309	.54			2-2322	.74		
2	2-2289	.41			2-2310	.58	2-2428	.99	2-2323	.84		
2 1/4	2-6300	.43			2-6302	.89						
2 1/2	2-2290	.45			2-2311	.69			2-2324	.97		
2 3/4	2-6301	.47										
3	2-2291	.51			2-2312	.79			2-2325	1.29		
3 1/2	2-2292	.86			2-2313	1.29			2-2326	1.78	2-2338	2.39
4	2-2293	.98			2-2314	1.47			2-2327	1.97		
6									2-2328	6.65		



SLOTTED FLAT JACKSON HEADS ; .40" O.D. HEAD - 1/4-20 X 1 #2-2301 \$ 2.40
 .42" O.D. HEAD - 1/4-20 X 3/4 2-2436 2.25
 5/16-24 X 2 2-2440 2.99
 5/16-24 X 3/4 2-2339 3.14
 5/16-24 X 1" 2-2335 3.17
 .47" O.D. HEAD - 5/16-18 X 7/8 2-2300 3.40
 SLOTTED FLAT MACHINE SCREW ASSORTMENT: 1720 PIECES # 3-3028 \$ 305.75
 PERSONAL ASSORTMENT: 850 PIECES 3-3171 148.00

OVAL MACHINE SCREWS

- PHILLIPS HEAD -

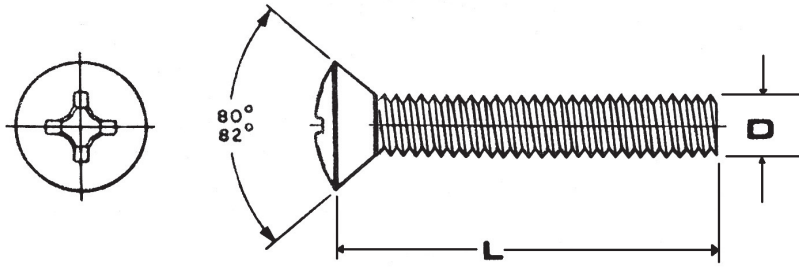

DIMENSION TABLE (INCHES)

D	DIAMETER	.112	.138	.164	.190	.190	.216	1/4	1/4	5/16	5/16
B	HEAD DIA.	.23	.28	.33	.39	.39	.44	.48	.48	.60	.60
	ISO #	4	6	8	10	10	12				
	THREADS/INCH	40	32	32	24	32	24	20	28	18	24

PART NUMBER AND PRICE GUIDE

SIZE:	4-40		6-32		8-32		10-24		10-32		12-24		1/4-20		1/4-28	
LENGTH	PART#	\$	PART#	\$	PART#	\$	PART#	\$	PART#	\$	PART#	\$	PART#	\$	PART#	\$
1/4	2-3290	.04	2-3232	.05	2-3251	.07	2-3238	.08	2-7523	.08						
5/16									2-7551	.09						
3/8	2-3295	.04	2-3200	.06	2-3207	.07	2-3215	.09	2-3223	.09			2-7523	.18	2-3249	.43
1/2	2-3292	.04	2-3201	.07	2-3208	.08	2-3216	.10	2-3224	.10	2-3239	.17	2-3231	.19	2-3250	.45
5/8			2-3202	.08	2-3209	.09	2-3217	.12	2-3225	.12	2-7526	.19	2-3242	.23	2-3252	.47
3/4	2-3293	.05	2-3203	.09	2-3210	.10	2-3218	.13	2-3226	.13	2-7527	.20	2-3233	.25	2-3260	.49
7/8					2-7521	.11	2-7522	.14	2-7524	.14			2-3257	.27		
1	2-3294	.06	2-3204	.11	2-3211	.12	2-3219	.15	2-3227	.15	2-3240	.28	2-3234	.36	2-3261	.52
1 1/4	2-7550	.14	2-3205	.12	2-3212	.14	2-3220	.16	2-3228	.16	2-7529	.32	2-3235	.38		
1 1/2			2-3206	.13	2-3213	.17	2-3221	.19	2-3229	.19	2-3264	.56	2-3236	.40		
1 3/4									2-7525	.21			2-7534	.42		
2			2-3124	.16	2-3214	.21	2-3222	.22	2-3230	.23			2-3237	.44		
2 1/2					2-3273	.29	2-3244	.39	2-3246	.40			2-3248	.46		
3							2-3245	.45	2-3247	.46	2-7532	.65	2-3241	.49		
3 1/2													2-7535	.52		
4													2-3259	.56		

PART NUMBER AND PRICE GUIDE

SIZE:	5/16-18		5/16-24	
LENGTH	PART#	\$	PART#	\$
1/2				
5/8				
3/4	2-3275	.39	2-3280	.69
1	2-3258	.48	2-3281	.79
1 1/4	2-7536	.59	2-3282	.89
1 1/2	2-3253	.63	2-3283	.98
1 3/4	2-7537	.69		
2	2-3254	.74		
2 1/2	2-3255	.98		
3	2-7538	1.19		

PART NUMBER AND PRICE GUIDE: JACKSON HEAD

SIZE:	8-32		10-32		1/4-20		1/4-20		5/16-18	
HEAD SIZE:	#6 HEAD		#8 HEAD		#10 HEAD		#12 HEAD		1/4 HEAD	
LENGTH	PART#	\$	PART#	\$	PART#	\$	PART#	\$	PART#	\$
3/8	2-3276	.19								
1/2	2-3277	.22	2-3284	.29	2-3243	.43				
5/8	2-3278	.24	2-3285	.30	2-3338	.44	2-3272	.55		
3/4	2-3289	.26	2-3286	.31	2-3270	.45	2-3344	.93	2-3336	1.99
7/8			2-3334	.32	2-3265	.49	2-3269	.59		
1	2-3279	.29	2-3287	.33			2-3291	.96	2-3268	.79
1 1/4			2-3288	.35			2-3274	.98	2-3266	.89
1 1/2									2-3267	.99

ADDITIONAL SIZES:

3/8-16 X 1	# 2-7540	\$.89
1 1/4	2-7541	.98
3	2-7549	1.97

NEW SIZE: 10-24 X 3/4 PHILLIPS OVAL JACKSON HEAD (#8 HEAD) # 2-3263 \$.78
 1/4-28 X 5/8 PHILLIPS OVAL JACKSON HEAD (#12 HEAD) 2-3262 1.38

PHILLIPS OVAL MACHINE SCREW SHOP ASSORTMENT: 1720 PIECES # 3-3029 \$ 256.75
 PERSONAL ASSORTMENT: 850 PIECES 3-3166 113.90

OVAL MACHINE SCREWS

- SLOTTED HEAD -

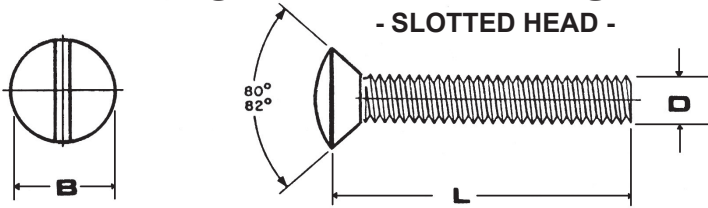

DIMENSION TABLE (INCHES)

D	DIAMETER	.112	.138	.164	.190	.190	.216	1/4	1/4	5/16	5/16	3/8	7/16
B	HEAD DIA.	.23	.28	.33	.39	.39	.44	.48	.48	.60	.60	.72	.75
ISO #		4	6	8	10	10	12						
THREADS/INCH		40	32	32	24	32	24	20	28	18	24	16	20



PART NUMBER AND PRICE GUIDE

ISO #	4-40		5-40		6-32		8-32		10-24		10-32		12-24	
LENGTH	PART#	\$			PART#	\$	PART#	\$	PART#	\$	PART#	\$	PART#	\$
1/4	2-3109	.04			2-3169	.05	2-3128	.08	2-2501	.19	2-3156	.19		
5/16	2-3110	.04			2-3118	.05								
3/8	2-3111	.04	2-3117	.09	2-3120	.06	2-3129	.09	2-3138	.21	2-3147	.21		
1/2	2-3112	.05			2-3121	.06	2-3130	.10	2-3139	.22	2-3148	.22	2-3170	.36
5/8	2-3113	.05			2-3122	.07	2-3131	.11	2-3140	.23	2-3149	.23		
3/4	2-3114	.05			2-3123	.07	2-3132	.12	2-3141	.24	2-3150	.24	2-3166	.39
7/8					2-7501	.08	2-7502	.13	2-7503	.25	2-3151	.25		
1	2-3179	.07			2-3125	.09	2-3134	.13	2-3143	.26	2-3152	.26	2-3167	.41
1 1/4	2-7500	.09			2-7519	.10	2-3135	.14	2-3144	.27	2-3153	.27	2-7505	.45
1 1/2					2-3127	.11	2-3136	.15	2-3145	.28	2-3154	.28	2-3171	.49
1 3/4							2-5362	.19	2-5363	.31	2-5364	.31		
2					2-3168	.13	2-3299	.21	2-3146	.34	2-3155	.34	2-3175	.58
2 1/2							2-5356	.28	2-5358	.39	2-5360	.99		
3							2-5357	.37	2-5359	.48	2-5361	.48		

PART NUMBER AND PRICE GUIDE

SIZE:	1/4-20		1/4-28		5/16-18		5/16-24		3/8-16	
LENGTH	PART#	\$	PART#	\$	PART#	\$	PART#	\$	PART#	\$
3/8	2-3160	.24								
1/2	2-3157	.26	2-3176	.34	2-7508	.54				
5/8	2-3158	.29	2-5321	.37						
3/4	2-3159	.31	2-3178	.39	2-3174	.59	2-3187	.79		
7/8	2-3183	.35								
1	2-3161	.38	2-3173	.44	2-3165	.67	2-3188	.89	2-3190	.79
1 1/4	2-3162	.44	2-5325	.49	2-5320	.69	2-3189	.98	2-7513	2.98
1 1/2	2-3163	.49			2-3115	.71			2-7514	2.98
1 3/4	2-7515	.58								
2	2-3164	.68			2-3298	.99			2-7510	2.98
2 1/2	2-7506	.76			2-7509	1.38	2-5336	12.90	2-7512	2.98
3	2-3119	.83			2-3133	1.79			2-7511	2.98
3 1/2	2-7507	.89								
4	2-3182	.98			2-2917	1.95				

SPECIAL SIZE:
 8-32 X 1 TYPE A
 #2-5393 \$1.49
 *FOR 1940
 CHEVY
 HEADLIGHT
 RINGS*

JACKSON (UNDERSIZED HEAD) SCREWS: 5/16-24 X 7/16 (# 12 HEAD) 2-5351 \$4.99 7/16-20 X 1 1/2 2-5333 \$ 13.60
 SCREWS - USED ON ANTIQUE DOOR X 1/2 2-5350 4.99
 HINGES - SEE PAGE 102 FOR FLAT SOCKETS X 5/8 2-5349 2.99* 1/4-20 X 1/2 2-5330 2.40
 WE CAN CUSTOM MAKE ANY SIZE X 3/4 2-5352 1.99* X 5/8 2-5331 2.43
 JACKSON HEAD SCREW - GIVE US A CALL X 1 2-5354 2.09* X 3/4 2-5332 2.45
 * NOT FULLY THREADED TO HEAD* X 1 1/4 2-5355 2.18* X 1 2-5334 2.52

SLOTTED OVAL MACHINE SCREW SHOP ASSORTMENT: 1720 PIECES # 3-3030 \$ 375.55
 PERSONAL ASSORTMENT: 850 PIECES 3-3172 152.00

PAN MACHINE SCREWS

- PHILLIPS HEAD -

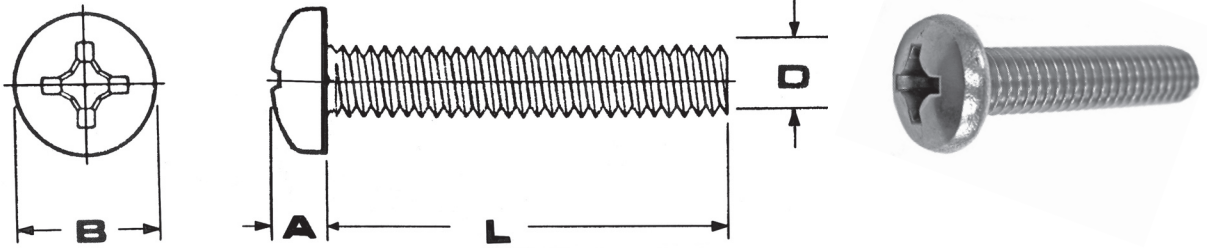

DIMENSION TABLE (INCHES)

D	DIAMETER	.112	.138	.164	.190	.190	.216	1/4	1/4	5/16	3/8
B	HEAD DIA.	.29	.27	.322	.373	.373	.416	.492	.492	.615	.74
A	HEAD HT.	.068	.082	.096	.11	.11	.119	.144	.144	.178	.212
ISO #		4	6	8	10	10	12				
THREADS/INCH		40	32	32	24	32	24	20	28	18	16

PART NUMBER AND PRICE GUIDE

SIZE:	4-40		6-32		8-32		10-24		10-32	
LENGTH	PART#	\$	PART#	\$	PART#	\$	PART#	\$	PART#	\$
1/4	2-2930	.03	2-2939	.05	2-2949	.05	2-2919	.07	2-2929	.07
5/16	2-2931	.04	2-2940	.04	2-2950	.06				
3/8	2-2932	.04	2-2941	.05	2-2951	.07	2-2962	.09	2-2973	.09
1/2	2-2933	.05	2-2942	.05	2-2952	.08	2-2963	.10	2-2974	.10
5/8	2-2934	.05	2-2943	.06	2-2953	.09	2-2964	.12	2-2975	.12
3/4	2-2935	.06	2-2944	.07	2-2954	.10	2-2965	.15	2-2976	.15
7/8			2-2903	.08	2-2960	.11	2-2875	.16	2-2970	.16
1	2-2936	.07	2-2945	.08	2-2956	.12	2-2966	.17	2-2977	.17
1 1/4	2-2927	.08	2-2946	.10	2-2957	.13	2-2967	.19	2-2978	.19
1 1/2	2-2928	.09	2-2947	.15	2-2958	.16	2-2968	.21	2-2979	.21
1 3/4			2-2905	.16	2-2909	.18	2-2898	.22	2-2874	.22
2			2-2971	.16	2-2959	.19	2-2969	.23	2-2980	.23
2 1/2			2-2972	.16	2-2913	.21	2-2982	.26	2-2992	.26
3							2-2983	.29	2-2993	.29

PART NUMBER AND PRICE GUIDE

SIZE:	12-24		1/4-20		1/4-28		5/16-18		3/8-16	
LENGTH	PART#	\$	PART#	\$	PART#	\$	PART#	\$	PART#	\$
3/8	2-2794	.17	2-2984	.19						
1/2	2-2711	.18	2-2985	.20	2-2925	.41	2-2995	.42		
5/8	2-2795	.21	2-2986	.22	2-2876	.43	2-2961	.60		
3/4	2-2722	.24	2-2987	.24	2-2938	.44	2-2955	.65		
7/8			2-2937	.25						
1	2-2796	.28	2-2988	.25	2-2877	.49	2-2996	.70	2-2948	.79
1 1/4			2-2989	.27	2-2878	.57				
1 1/2	2-2798	.36	2-2990	.31	2-2879	.69	2-2997	.75		
1 3/4	2-2799	.44	2-2872	.34						
2			2-2991	.37			2-2998	.82		
2 1/2			2-2981	.39			2-2999	1.18		
3			2-2994	.44			2-2880	1.39		
3 1/2			2-2873	.58						

PHILLIPS PAN MACHINE SCREW SHOP ASSORTMENT: 1720 PIECES # 3-3031 \$215.50
 PERSONAL ASSORTMENT: 850 PIECES 3-3167 125.00

PAN MACHINE SCREWS

- SLOTTED HEAD -

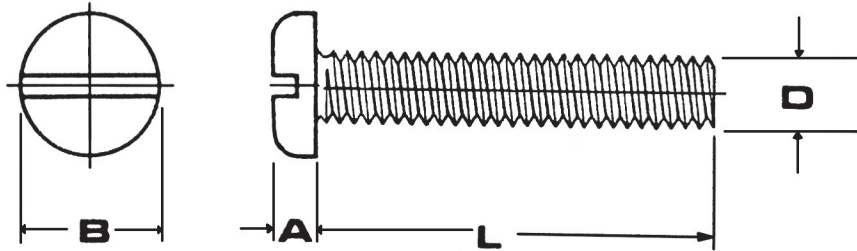

DIMENSION TABLE (INCHES)

D	DIAMETER	.112	.138	.164	.190	.190	.216	1/4	1/4	5/16	3/8
B	HEAD DIA.	.219	.27	.322	.373	.373	.416	.492	.492	.615	.74
A	HEAD HT.	.068	.082	.096	.11	.11	.119	.144	.144	.178	.212
	ISO #	4	6	8	10	10	12				
	THREADS/INCH	40	32	32	24	32	24	20	28	18	16

PART NUMBER AND PRICE GUIDE

SIZE:	4-40		6-32		8-32		10-24		10-32	
LENGTH	PART#	\$	PART#	\$	PART#	\$	PART#	\$	PART#	\$
1/4	2-2701	.04	2-2712	.06	2-2725	.09	2-2739	.09	2-2753	.09
5/16	2-2702	.04	2-2713	.06	2-2726	.08			2-2754	.10
3/8	2-2703	.04	2-2714	.06	2-2727	.08	2-2741	.10	2-2755	.11
1/2	2-2704	.05	2-2715	.07	2-2728	.08	2-2742	.11	2-2756	.13
5/8	2-2705	.05	2-2716	.07	2-2729	.09	2-2743	.12	2-2757	.14
3/4	2-2706	.06	2-2717	.08	2-2730	.10	2-2744	.13	2-2758	.15
7/8	2-2707	.06	2-2718	.08	2-2731	.11	2-2726	.15	2-2759	.16
1	2-2708	.07	2-2719	.09	2-2732	.12	2-2746	.16	2-2760	.17
1 1/4	2-2710	.09	2-2720	.10	2-2733	.13	2-2747	.18	2-2761	.19
1 1/2	2-2709	.11	2-2721	.13	2-2734	.15	2-2748	.19	2-2762	.21
1 3/4					2-2735	.17	2-2749	.24	2-2763	.24
2			2-2723	.13	2-2736	.19	2-2750	.29	2-2764	.29
2 1/2					2-2837	.24	2-2751	.39	2-2765	.39
3					2-2724	.38				



PART NUMBER AND PRICE GUIDE

SIZE:	12-24		1/4-20		1/4-28		5/16-18		3/8-16	
LENGTH	PART#	\$	PART#	\$	PART#	\$	PART#	\$	PART#	\$
3/8	2-2768	.29	2-2881	.29	2-2894	.54				
1/2	2-2769	.34	2-2882	.30	2-2895	.58	2-2906	.49	2-2918	.78
5/8	2-2770	.37	2-2883	.31	2-2896	.59	2-2907	.54		
3/4	2-2771	.39	2-2884	.32	2-2897	.62	2-2908	.59	2-2920	.88
7/8			2-2885	.36						
1	2-2773	.41	2-2886	.39	2-2899	.69	2-2910	.64	2-2922	.99
1 1/4			2-2887	.44	2-2900	.74	2-2911	.69		
1 1/2	2-2775	.49	2-2888	.46			2-2912	.79	2-2924	1.07
1 3/4			2-2893	.48						
2	2-2777	.54	2-2890	.49			2-2914	.99	2-2926	1.18
2 1/2			2-2891	.55			2-2915	1.18		
3			2-2892	.59			2-2916	1.37		

UNSLOTTED PAN HEAD: 1/4-20 X 3/4 # 2-2902 \$.29

SLOTTED PAN MACHINE SCREW SHOP ASSORTMENT: 1720 PIECES # 3-3032 \$302.40
 PERSONAL ASSORTMENT: 850 PIECES 3-3173 149.95

ROUND MACHINE SCREWS

- PHILLIPS HEAD -

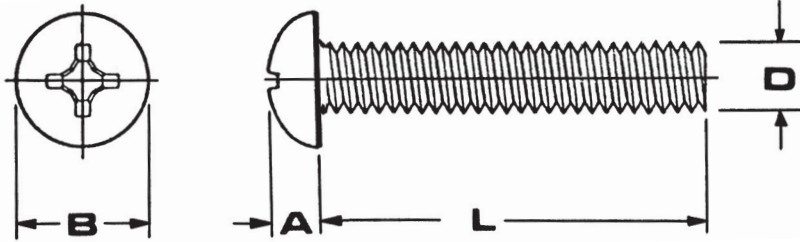

DIMENSION TABLE (INCHES)

D	DIAMETER	.112	.138	.164	.190	.190	1/4	5/16
B	HEAD DIA.	.211	.26	.309	.359	.359	.472	.59
A	HEAD HT.	.086	.103	.12	.137	.137	.175	.216
ISO #		4	6	8	10	10		
THREADS/INCH		40	32	32	24	32	20	18

PART NUMBER AND PRICE GUIDE

SIZE:	4-40		6-32		8-32		10-24		10-32		12-24	
LENGTH	PART#	\$	PART#	\$	PART#	\$	PART#	\$	PART#	\$	PART#	\$
3/16			2-2682	.05								
1/4	2-2630	.04	2-2636	.05	2-2645	.06	2-2654	.10	2-2664	.10		
3/8	2-2631	.04	2-2637	.05	2-2646	.07	2-2656	.11	2-2665	.11		
1/2	2-2632	.05	2-2638	.06	2-2647	.07	2-2657	.12	2-2666	.12	2-7803	.19
5/8	2-2633	.06	2-2639	.07	2-2648	.08	2-2658	.13	2-2667	.13	2-7804	.23
3/4	2-2634	.06	2-2640	.08	2-2649	.09	2-2659	.14	2-2668	.14	2-7805	.29
7/8			2-2615	.09	2-2618	.10	2-7815	.15	2-7800	.15		
1	2-2635	.07	2-2641	.09	2-2650	.10	2-2660	.16	2-2669	.16	2-2681	.32
1 1/4	2-2627	.09	2-2642	.11	2-2651	.12	2-2661	.17	2-2670	.19		
1 1/2	2-2628	.11	2-2643	.12	2-2652	.14	2-2662	.19	2-2671	.20		
2			2-2644	.14	2-2653	.19	2-2663	.22	2-2672	.24		
2 1/2							2-2683	.44	2-7816	.36		
3							2-2698	.49	2-2686	.49		
4												

ADDITIONAL SIZE:
 3/8-16 X 3/4 2-7818 \$.60
 3/8-16 X 1 1/4 2-2697 \$.83

UNSLOTTED ROUND HEAD SCREWS:

4-40 x 3/8 # 2-2616 \$.28
 4-40 x 3/4 2-2474 .29
 6-32 x 5/8 2-2614 .34



SIZE:	1/4-20		1/4-28		5/16-18	
LENGTH	PART#	\$	PART#	\$	PART#	\$
3/8	2-2673	.15				
1/2	2-2674	.16	2-7807	.29	2-2690	.36
5/8	2-2675	.17	2-7808	.38	2-7812	.38
3/4	2-2676	.18	2-2689	.49	2-2691	.39
7/8						
1	2-2677	.20	2-7810	.58	2-2692	.45
1 1/4	2-2678	.24				
1 1/2	2-2679	.27	2-7811	.69	2-2693	.62
2	2-2680	.39			2-2694	.82
2 1/4	2-2687	.42			2-2695	1.00
2 1/2	2-7817	.38				
3	2-2688	.49				
4	2-7806	.99				



DAD WITH MY COUSIN (NOW MY STEP BROTHER) AND HIS DAD ON OUR 1926 MACK CHAIN DRIVE FIRE TRUCK BACK IN 80'S.

PHILLIPS ROUND MACHINE SCREW SHOP ASSORTMENT: 1720 PIECES # 3-3033 \$ 197.50
 PERSONAL ASSORTMENT: 850 PIECES 3-3174 125.00

ROUND MACHINE SCREWS

- SLOTTED HEAD -

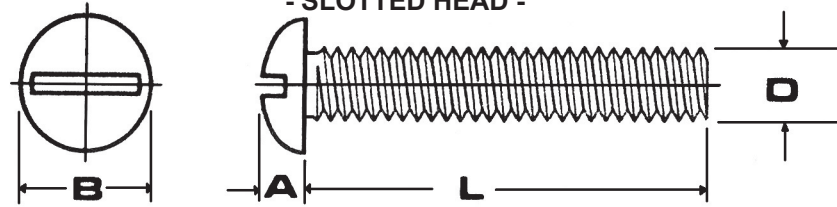

DIMENSION TABLE (INCHES)

D	DIAMETER	.086	.112	.138	.164	.190	.190	1/4	1/4	5/16	3/8	1/2
B	HEAD DIA.	.15	.211	.26	.309	.359	.359	.472	.472	.59	.62	.78
A	HEAD HT.	.07	.086	.103	.12	.137	.137	.175	.175	.216	.26	.37
ISO #		2	4	6	8	10	10					
THREADS/INCH		56	40	32	32	24	32	20	28	18	16	13

PART NUMBER AND PRICE GUIDE

SIZE:	2-56		4-40		6-32		8-32		10-24		10-32	
LENGTH	PART#	\$	PART#	\$	PART#	\$	PART#	\$	PART#	\$	PART#	\$
3/16			2-2450	.07	2-2462	.08	2-2476	.08				
1/4			2-2451	.07	2-2463	.08	2-2477	.10	2-2492	.14	2-2507	.14
5/16			2-2452	.07	2-2464	.09	2-2478	.10	2-2493	.15	2-2508	.15
3/8			2-2453	.07	2-2465	.09	2-2479	.10	2-2494	.16	2-2509	.16
7/16					2-2466	.09	2-2480	.11				
1/2	2-2458	.08	2-2455	.08	2-2467	.09	2-2481	.11	2-2496	.17	2-2511	.14
5/8			2-2456	.09	2-2468	.09	2-2482	.11	2-2497	.18	2-2512	.18
3/4			2-2457	.09	2-2469	.10	2-2483	.12	2-2498	.19	2-2513	.19
7/8					2-2475	.11	2-2495	.13	2-2499	.20	2-2514	.20
1			2-2459	.10	2-2471	.11	2-2485	.14	2-2500	.21	2-2515	.21
1 1/4			2-2641	.11	2-2472	.13	2-2486	.14	2-2501	.23	2-2516	.23
1 1/2	2-2470	.12					2-2487	.18	2-2502	.26	2-2517	.26
1 3/4									2-2503	.29	2-2518	.29
2							2-2489	.22	2-2504	.32	2-2519	.33
2 1/4											2-2522	.38
2 1/2							2-2490	.26	2-2505	.42	2-2520	.42
3							2-2491	.27	2-2506	.49	2-2521	.49
3 1/2											2-2523	.84

SIZE:	12-24		1/4-20		1/4-28		5/16-18		3/8-16		1/2-13	
LENGTH	PART#	\$	PART#	\$	PART#	\$	PART#	\$	PART#	\$	PART#	\$
3/8	2-2524	.19	2-2580	.27	2-2594	.45						
1/2	2-2526	.22	2-2581	.28	2-2595	.48	2-2602	.45	2-7850	.65		
5/8	2-2527	.24	2-2582	.30			2-2603	.49				
3/4	2-2528	.25	2-2583	.32	2-2597	.53	2-2604	.54	2-2617	.78		
7/8	2-2525	.29										
1	2-2530	.31	2-2585	.35	2-2599	.58	2-2606	.59	2-2619	.88		
1 1/4	2-2531	.37	2-2586	.40	2-2600	.61	2-2607	.62	2-2620	.92		
1 1/2	2-2532	.39	2-2587	.48	2-2601	.67	2-2608	.68	2-2621	.96		
1 3/4			2-2588	.49			2-2609	.99				
2	2-2534	.46	2-2589	.52			2-2610	.77	2-2623	1.14		
2 1/2			2-2590	.58			2-2611	.79	2-2624	1.25	2-2629	3.80
3			2-2591	.69			2-2612	.84	2-2625	1.98		
3 1/2			2-2592	.84			2-2613	.90	2-2626	2.49		

SLOTTED ROUND MACHINE SCREW SHOP ASSORTMENT: 1720 PIECES # 3-3056 \$ 342.85
 PERSONAL ASSORTMENT: 850 PIECES 3-3175 165.00

TRUSS MACHINE SCREWS

- PHILLIPS HEAD -

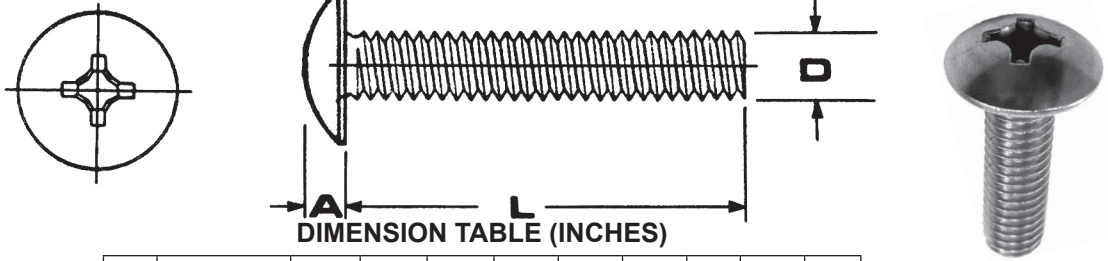

DIMENSION TABLE (INCHES)

D	DIAMETER	.112	.138	.164	.190	.190	.220	1/4	5/16	3/8
A	HEAD HT.	.069	.086	.102	.118	.118	.125	.15	.18	.22
B	HEAD DIA.	.257	.321	.384	.448	.448	.500	.57	.64	.81
ISO #		4	6	8	10	10	12			
THREADS/INCH		40	32	32	24	32	24	20	18	16

PART NUMBER AND PRICE GUIDE

SIZE:	4-40		6-32		8-32		10-24		10-32		12-24		1/4-20	
LENGTH	PART#	\$	PART#	\$	PART#	\$	PART#	\$	PART#	\$	PART#	\$	PART#	\$
1/4	2-3051	.04	2-3058	.05	2-3067	.08	2-3316	.09	2-3319	.09				
5/16	2-3052	.05	2-3059	.05	2-3068	.07								
3/8	2-3053	.05	2-3060	.06	2-3069	.08	2-3078	.10	2-3087	.10			2-3095	.17
1/2	2-3054	.05	2-3061	.06	2-3070	.09	2-3079	.11	2-3088	.11	2-3126	.24	2-3096	.19
5/8			2-3062	.07	2-3071	.10	2-3080	.12	2-3089	.13	2-3312	.26	2-3097	.21
3/4	2-3055	.09	2-3063	.08	2-3072	.11	2-3081	.15	2-3090	.14	2-3313	.29	2-3098	.23
7/8					2-3314	.12								
1			2-3064	.09	2-3073	.12	2-3082	.17	2-3091	.16			2-3099	.27
1 1/4			2-3065	.09	2-3074	.14	2-3083	.19	2-3092	.19			2-3100	.31
1 1/2			2-3066	.09	2-3075	.16	2-3084	.20	2-3093	.20			2-3101	.35
1 3/4					2-3315	.19	2-3317	.24	2-3320	.24			2-3321	.37
2							2-3085	.27	2-3094	.26			2-3102	.39
2 1/4							2-3318	.35					2-3323	.42
2 1/2							2-3108	.39					2-3014	.44
3							2-3197	.44					2-3104	.49
3 1/2									2-3086	.87				

PHILLIPS TRUSS
MACHINE SCREW
SHOP ASSORTMENT:
1720 PIECES
3-3034 \$ 237.70

PHILLIPS TRUSS
MACHINE SCREW
PERSONAL
ASSORTMENT: 850
PIECES
3-3168 \$ 125.00

SIZE:	5/16-18		3/8-16	
LENGTH	PART#	\$	PART#	\$
1/2	2-3322	.43		
5/8	2-3198	.45		
3/4	2-3107	.49	2-3325	.99
1	2-3025	.53	2-3186	1.18
1 1/4	2-3004	.55	2-3194	1.29
1 1/2	2-3034	.57		
2	2-3005	.69		
2 1/4			2-3192	1.98
2 1/2	2-3106	1.09	2-3193	2.46

TRUSS SOCKET MACHINE SCREWS

*BUTTON HEADS WITH BIGGER HEADS! GREAT FOR HANGING REAR FENDERS ON STEPSIDE TRUCKS!

SIZE:	12-24		1/4-20		5/16-18	
LENGTH	PART#	\$	PART#	\$	PART#	\$
1/2	2-3076	.49	2-3137	.59		
5/8			2-3350	.62		
3/4	2-3103	.54	2-3185	.64	2-3195	.96
1	2-3116	.59	2-3191	.69	2-3196	1.04
1 1/4					2-3327	1.19

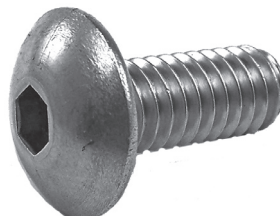

TRUSS MACHINE SCREWS

- SLOTTED HEAD -

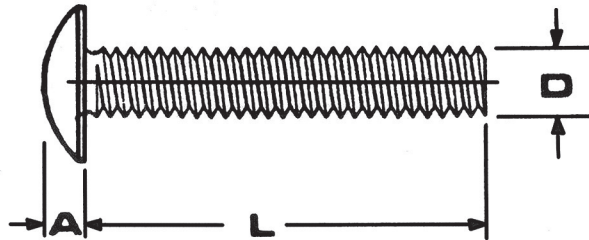
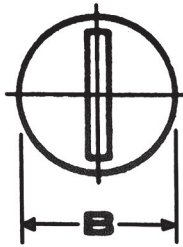

DIMENSION TABLE (INCHES)

D	DIAMETER	.112	.138	.164	.190	.190	1/4	5/16
A	HEAD HT.	.069	.086	.102	.118	.118	.15	.18
B	HEAD DIA.	.257	.321	.384	.448	.448	.57	.64
	ISO #	4	6	8	10	10		
	THREADS/INCH	40	32	32	24	32	20	18

PART NUMBER AND PRICE GUIDE

SIZE:	4-40		6-32		8-32		10-24		10-32		1/4-20		1/4-28		5/16-18	
LENGTH	PART#	\$	PART#	\$	PART#	\$	PART#	\$	PART#	\$	PART#	\$	PART#	\$	PART#	\$
1/4	2-3000	.04	2-3007	.08	2-3016	.09	2-3306	.12	2-3309	.12						
5/16	2-3001	.05	2-3008	.09	2-3017	.09			2-3310	.13						
3/8	2-3002	.05	2-3009	.09	2-3018	.09	2-3026	.13	2-3035	.13	2-3043	.26				
1/2	2-3003	.05	2-3010	.09	2-3019	.10	2-3027	.14	2-3036	.14	2-3044	.27	2-3351	.28	2-3172	.38
5/8			2-3011	.09	2-3020	.11	2-3028	.15	2-3037	.15	2-3045	.29	2-3180	.31	2-3142	.44
3/4	2-3056	.09	2-3012	.10	2-3021	.12	2-3029	.15	2-3038	.15	2-3046	.31			2-3331	.48
7/8							2-3354	.16								
1	2-3006	.09	2-3013	.11	2-3022	.13	2-3030	.16	2-3039	.16	2-3047	.35	2-3352	.36	2-3077	.53
1 1/4					2-3023	.36	2-3031	.37	2-3040	.38	2-3048	.57			2-3346	.81
1 1/2			2-3303	.37	2-3024	.38	2-3032	.39	2-3041	.40	2-3049	.59			2-3347	.92
1 3/4							3-3311	.41			2-3356	.60			2-3353	.99
2					2-3305	.40	2-3033	.43	2-3042	.44	2-3050	.68			2-3177	1.24
2 1/2							2-3307	.49			2-3329	.85				
3							2-3308	.56			2-3330	.89				

SLOTTED TRUSS ADDITIONAL SIZES: 12-24 X 1/2 #2-3355 \$.24
 12-24 X 1 2-3328 .30
 3/8-16 X 1 2-3348 1.29
 3/8-16 X 1 1/4 2-3349 1.59
 3/8-16 X 1 1/2 2-3015 1.69

SLOTTED TRUSS MACHINE SCREW SHOP ASSORTMENT: 1720 PIECES # 3-3057 \$ 346.55
 PERSONAL ASSORTMENT: 850 PIECES 3-3164 133.00

UNSLOTTED TRUSS MACHINE SCREWS

- USED TO REPLACE RIVETS -

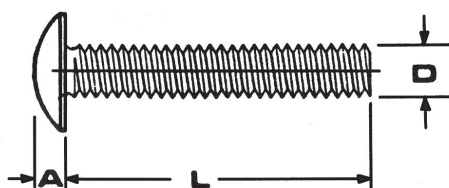

SIZE:	6-32		8-32		10-32	
LENGTH	PART#	\$	PART#	\$	PART#	\$
1/2	2-3057	.50				
5/8			2-3199	.75	2-3105	.79
3/4	2-3359	.55				

HEX SOCKET SET SCREWS

LONG SET SCREWS WORK GREAT AS STUDS!



D	DIAMETER	.112	.138	.164	.190	.190	1/4	1/4	5/16	5/16	3/8	3/8	1/2
C	KEY SIZE	.050	1/16	5/64	3/32	3/32	1/8	1/8	5/32	5/32	3/16	3/16	1/4
ISO #		4	6	8	10	10							
THREADS/INCH		40	32	32	24	32	20	28	18	24	16	24	13

PART NUMBER AND PRICE GUIDE

SIZE:	4-40		6-32		8-32		10-24		10-32		1/4-20	
LENGTH	PART#	\$	PART#	\$	PART#	\$	PART#	\$	PART#	\$	PART#	\$
1/8	2-1703	.08	2-1708	.09	2-1720	.09						
3/16	2-1701	.08	2-1709	.09	2-1721	.09	2-1730	.11	2-1737	.13	2-1748	.13
1/4	2-1702	.10	2-1710	.10	2-1722	.11	2-1731	.12	2-1738	.14	2-1749	.13
5/16			2-1711	.11	2-1723	.11	2-1732	.13	2-1739	.15	2-1750	.16
3/8	2-1704	.12	2-1712	.12	2-1724	.12	2-1733	.14	2-1740	.16	2-1751	.17
1/2	2-1705	.14	2-1713	.14	2-1725	.14	2-1734	.15	2-1741	.19	2-1752	.19
5/8	2-1706	.19	2-1714	.17					2-1742	.21	2-1754	.22
3/4			2-1715	.18	2-1726	.19	2-1735	.24	2-1743	.24	2-1755	.24
1			2-1716	.25	2-1727	.25	2-1745	.24	2-1744	.27	2-1756	.25
1 1/4									2-1746	.30	2-1753	.36
1 1/2			2-1717	.49							2-1757	.47
2											2-1758	.59
2 1/2											2-1759	1.40
3											2-1736	1.58

SIZE:	1/4-28		5/16-18		5/16-24		3/8-16		3/8-24		1/2-13	
LENGTH	PART#	\$	PART#	\$	PART#	\$	PART#	\$	PART#	\$	PART#	\$
3/16	2-1760	.18										
1/4	2-1762	.18	2-1770	.22	2-1780	.30	2-1789	.27	2-1796	.37		
5/16	2-1763	.19	2-1771	.26	2-1781	.31	2-1790	.31				
3/8	2-1764	.19	2-1772	.28	2-1782	.32	2-1791	.32	2-1798	.39	2-1805	.59
1/2	2-1765	.23	2-1773	.35	2-1783	.37	2-1792	.39	2-1799	.42	2-1806	.62
5/8	2-1747	.29	2-1774	.36			2-1793	.46				
3/4	2-1767	.33	2-1761	.42			2-1794	.53	2-1801	.59	2-1808	.85
1	2-1768	.36	2-1777	.46	2-1786	.48	2-1776	.69	2-1802	.74	2-1809	.98
1 1/4			2-1778	.61	2-1787	.62	2-1795	.79	2-1797	1.39		
1 1/2	2-1718	.49	2-1779	.72			2-1818	.89				
2			2-1788	1.02			2-1819	1.29				
2 1/2			2-1775	1.42			2-1700	2.85				
3			2-1766	2.01			2-1800	3.70				

ADDITIONAL SIZES: 7/16-14 X 1/2 # 2-7300 \$.69 7/16-20 X 1/2 # 2-1784 \$.68 1/2-13 X 2 1/4 2-1817 2.69
 X 3/4 # 2-1785 .79 X 3/4 # 2-1707 \$.99 1/2-20 X 3/4 2-1719 1.16

PERSONAL ASSORTMENT: 345 PIECES 3-3141 125.00



TOLL FREE ORDER LINE : 1-800-767-4781

HIGH STRENGTH STUDS

SIZE:	1/4-20/28		5/16-18/24		3/8-16/24	
LENGTH	PART#	\$	PART#	\$	PART#	\$
1 1/8	2-1916	7.81				
1 1/2	2-1906	7.94				
1 5/8			2-1901	8.05	2-1905	9.16
1 3/4	2-1907	8.11	2-1914	8.25		
2					2-1902	9.31
2 1/4	2-1908	8.88	2-1904	8.80		
2 1/2					2-1915	9.55
2 3/4	2-1912	9.33	2-1911	8.98		
3	2-1913	9.90				
3 1/4			2-1910	9.22		
3 3/4					2-1903	11.62

170,000 PSI STUDS
-GREAT FOR EXHAUST MANIFOLDS-



LOWER STUD PICTURED ABOVE
 7/16-14/14 X 2 #2-7054 \$9.75
 7/16-14/14 X 2 1/2 2-7053 13.79
 7/16-14/14 X 2 3/4 2-7056 13.95

USED ON MOST STOCK FOR EXHAUST MANIFOLDS
-BOTH ENDS ARE COARSE THREAD-

****WE CUSTOM MAKE STUDS IN 300 SERIES AND 17-4 STAINLESS, SEE EXAMPLES BELOW.**
JUST CALL US WITH THE SIZE YOU NEED!

CUSTOM MADE 17-4 PH STUDS - MADE TO ORDER - NOT STOCK ITEMS

PART #	THREAD	OVERALL LENGTH	THREAD LENGTH	PRICE
2-7011	3/8-24	1.71	.65" OF THREAD ON EACH END	12.49
2-7012	3/8-24	2.04	.65" ON ONE END & .80" ON THE OTHER	12.74
2-7013	3/8-24	2.18	.63" ON ONE END & 1.18" WITH THE DOG POINT END FOR 1955-57 T-BIRDS	12.98
2-7023	3/8-16/24	2.25	.5625" OF 3/8-16 & .6875" OF 3/8-24 ON THE BALL END	16.96
2-7024	3/8-16	2.25	1" ON ONE END & 1.125" ON THE OTHER	12.79
2-7046	3/8-16	2.69	1" ON ONE END & 1.125" ON THE OTHER	12.97
2-6993	3/8-16	3	1" OF THREAD ON EACH END	12.90
2-7021	3/8-16	3-1/4	1-1/4" OF THREAD ON EACH END	13.34
2-7050	3/8-16	7	.5" ON ONE END & 1.5" ON THE OTHER (SWAY BAR)	13.78
2-7098	3/8-16	8	.5" ON ONE END & 1.5" ON THE OTHER (SWAY BAR)	14.57
2-7051	3/8-16	8.5	.5" ON ONE END & 1.5" ON THE OTHER (SWAY BAR)	14.99
2-7053	7/16-14	2.5	1" ON EACH END	13.79
2-7081	7/16-14	7	1/2" ON ONE END AND 1" ON THE OTHER	20.66
2-7082	7/16-14	7.5	1/2" ON ONE END AND 1" ON THE OTHER	20.98
2-7086	7/16-14	8	1/2" ON ONE END AND 1" ON THE OTHER	21.58
2-7150	1/2-13	7	1/2" ON ONE END AND 11/4" ON THE OTHER	22.98
2-7067	7/16-14/20	3.5	.75" ON THE 7/16-14 END & 1.25" ON THE 7/16-20 END	19.86
2-7059	7/16-14/20	4.5	1" ON THE 7/16-14 END & .8125" ON THE 7/16-20 END	20.99
2-7058	7/16-14/20	5.75	1.25" ON THE 7/16-14 END & .625" ON THE 7/16-20 END	21.46
2-7064	7/16-14/20	7	1" ON THE 7/16-14 END & .5" ON THE 7/16-20 END	21.84
2-7063	7/16-14/20	7.5	1" ON THE 7/16-14 END & .5" ON THE 7/16-20 END	22.96
2-7066	7/16-20	7.62	1" ON ONE END & 1.25" ON THE OTHER	21.77
2-7068	1/2-13/20	4	1.125" ON 1/2-13 END & 1.3125 ON THE 1/2-20 END	24.98
2-7074	1/2-13/20	4.5	2" ON 1/2-13 END & 1.3125 ON THE 1/2-20 END	25.76
2-7076	1/2-13/20	6.16	2" ON 1/2-13 END & 1.3125 ON THE 1/2-20 END	27.59
2-7085	5/8-11/18	8.5	1.25" ON THE 5/8-11 END & 1.75 ON THE 5/8-18 END	37.68

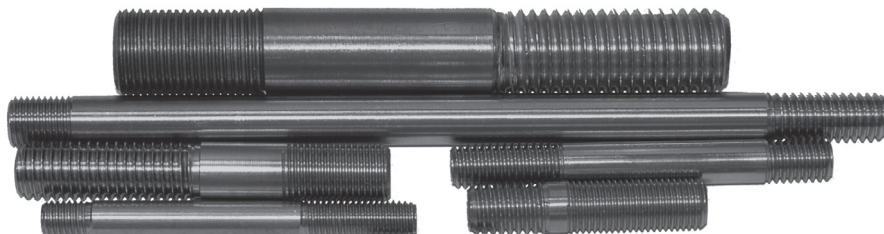

STANDARD 18-8 SS SHOULDER BOLTS

D	THREAD	T	A	H	KEY SIZE
5/16	1/4-20	7/16	7/16	7/32	5/32
3/8	5/16-18	1/2	9/16	1/4	3/16
1/2	3/8-16	5/8	3/4	5/16	1/4

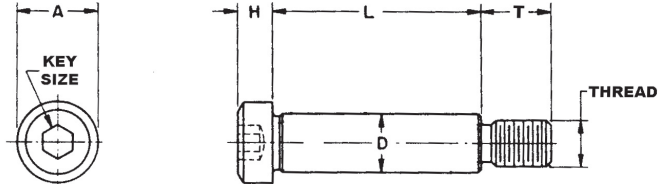

SIZE (D)		5/16		3/8		1/2	
LENGTH (L)	PART #	\$	PART #	\$	PART #	\$	
5/16	2-8218	3.75					
3/8	2-8219	4.00	2-8238	4.25	2-8271	4.35	
1/2	2-8220	4.15	2-8239	4.35	2-8272	4.50	
5/8	2-8221	4.25	2-8240	4.50	2-8273	4.65	
3/4	2-8222	4.30	2-8241	4.65	2-8274	4.75	
1	2-8223	4.50	2-8242	4.75	2-8275	5.00	
1 1/4	2-8224	4.65	2-8243	5.00	2-8276	5.25	
1 1/2			2-8244	5.25	2-8277	5.50	



OUR CUSTOM MADE SHOULDER BOLTS ARE MADE FROM HIGH STRENGTH 17-4 PH SS SUCH AS IN THE KITS AT THE RIGHT:

8) BOLTS FOR 1949-51 MERCURY HOOD HINGES:
 BUTTON HEAD 9-5000 154.00
 HEX HEAD 9-5001 155.00

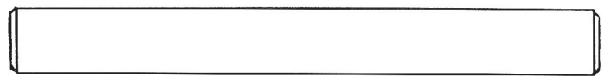

THREADED & BAR STOCK

- ALL ROD IS SOLD IN FEET -

- 3 FOOT MAXIMUM FOR THREADED ROD & UNTHREADED - \$5.00 SURCHARGE FOR 2 TO 3 FOOT PIECES

THREADED

SIZE	PART#	\$
6-32	2-1350	1.95
8-32	2-1351	2.30
10-24	2-1352	2.85
10-32	2-1353	2.85
12-24	2-1324	2.89
1/4-20	2-1354	2.96
1/4-28	2-1355	2.96
5/16-18	2-1356	3.30
5/16-24	2-1357	3.70
3/8-16	2-1358	3.90
3/8-24	2-1359	4.40

SIZE	PART#	\$
7/16-14	2-1369	5.80
7/16-20	2-1370	6.90
1/2-13	2-1360	6.40
1/2-20	2-1361	7.40
9/16-18	2-1331	16.60
5/8-11	2-1364	6.90
5/8-18	2-1362	7.90
3/4-10	2-1366	8.90
3/4-16	2-1367	12.50

303 SS ROUND

SIZE	PART#	\$
3/16	2-1388	2.40
1/4	2-1392	2.90
5/16	2-1393	4.30
3/8	2-1394	5.50
7/16	2-1395	7.50
1/2	2-1396	8.60
9/16	2-1340	10.90
5/8	2-1397	11.90
3/4	2-1398	16.90
7/8	2-1384	18.60
1	2-1399	19.90
1 1/4	2-1390	34.50
1 1/2	2-1386	57.00
1 3/4	2-1389	68.00
2	2-1391	88.00
2 1/4	2-1349	94.00
2 1/2	2-1332	99.00

17-4 PH HIGH STRENGTH ROUND BAR

HEAT TREATED TO H925 STRONGER THAN GRADE 8 STEEL BOLTS IN STRENGTH

SIZE	PART#	\$
3/8	2-1375	10.95
7/16	2-1376	11.80
1/2	2-1377	12.90
9/16	2-1333	15.20
5/8	2-1378	18.30
3/4	2-1379	25.90
7/8	2-1330	33.40
1	2-1363	40.80

303 SS SQUARE BAR

SIZE	PART#	\$
5/8	2-1347	15.80
3/4	2-1368	19.60
7/8	2-1334	33.70
1	2-1385	44.60

303 SS HEX BAR

SIZE	PART#	\$
3/8	2-1343	4.90
7/16	2-1365	8.80
1/2	2-1380	12.70
9/16	2-1372	14.40
5/8	2-1373	16.60
3/4	2-1374	24.90
7/8	2-1383	32.40
15/16	2-1338	47.80
1	2-1346	36.60
1-1/16	2-1339	48.50

17-4PH (annealed) HEX

SIZE	PART#	\$
5/8	2-1341	25.80
3/4	2-1345	30.70
7/8	2-1336	60.60
1	2-1335	89.70

304 1/2 ROUND BAR
 1/2" WIDE - 2-9905 \$8.80/FT

HIGH STRENGTH U-BOLTS

WE USE THESE U-BOLTS IN OUR SUSPENSION KITS
 - THEY EQUAL OR EXCEED 'GRADE 8'
 *MADE IN THE USA FROM 17-4 PH HEAT TREATED
 CERTIFIED STAINLESS!*

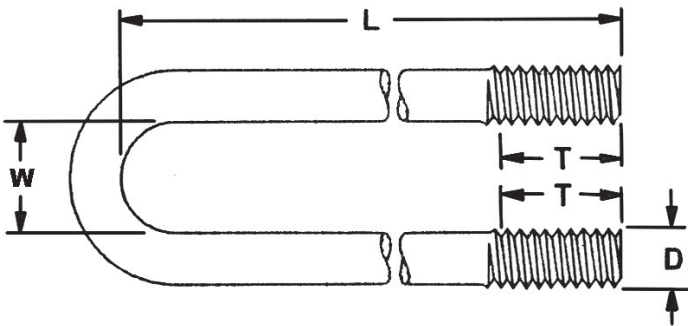

*** WE CUSTOM MAKE U-BOLTS TO
 YOUR SPECIFICATIONS UP TO 5/8"***
303 SS OR 17-4 PH

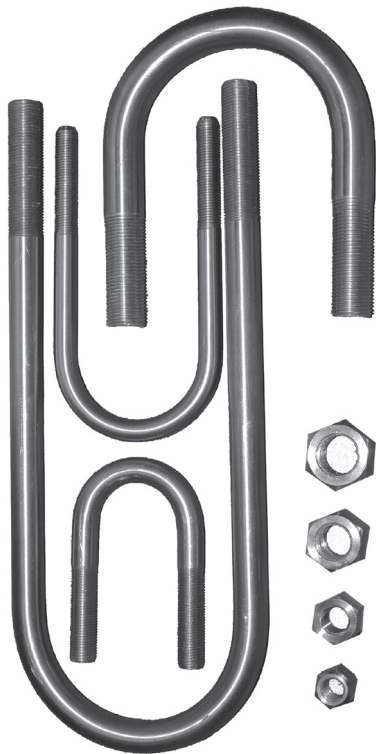

PART#	STK	\$	D	L	W	T
2-3750		22.90	3/8-24	6	2 3/8	2
2-3698	*	23.50	7/16-20	5 1/2	2 3/8	2 1/2
2-3696		29.40	7/16-20	8	2 3/8	2 1/2
2-3699	*	23.80	7/16-20	7	2 25/32	2 3/4
2-3761		31.70	7/16-20	8	2 25/32	2 1/2
2-3700		23.90	7/16-20	6 3/4	3 1/16	2 1/2
2-3730		27.60	1/2-20	5 1/2	2 3/8	2 1/2
2-3719		29.80	1/2-20	7	2 3/8	2 1/2
2-3702	*	22.90	1/2-20	3 1/4	1 9/16	1 3/4
2-3704	*	27.40	1/2-20	6	2 9/16	2 1/2
2-3701		28.40	1/2-20	7	2 9/16	2 1/2
2-3711	*	28.60	1/2-20	7	2 3/4	2 1/2
2-3735		31.90	1/2-20	7 3/4	2 7/8	2 1/2
2-3718		32.80	1/2-20	8 1/2	2 7/8	2 1/2
2-3717	*	28.40	1/2-20	6	3 1/16	2 1/2
2-3705	*	28.70	1/2-20	6 3/4	3 1/16	2 1/2
2-3712	*	33.90	1/2-20	8 1/2	3 1/16	2 1/2
2-3729		36.70	1/2-20	10	3-1/6	2
2-3706	*	28.80	1/2-20	6 1/2	3 1/4	2 1/2
2-3707	*	33.90	1/2-20	8	3 1/4	2 1/2
2-3771		35.90	9/16-18	7 1/2	3 1/16	2
2-3767		35.90	9/16-18	7	3 5/16	2
2-3774		36.60	9/16-18	6 3/4	3 3/8	2
2-3733		35.90	5/8-18	7 1/2	2 13/16	2
2-3708	*	36.60	5/8-18	7	3 1/16	2
2-3721		37.50	5/8-18	8 1/2	3 1/16	2
2-3723		38.90	5/8-18	9	3 1/16	2
2-3720		39.80	5/8-18	8 1/2	3 3/16	2
2-3726		43.90	5/8-18	10	3 3/16	2
2-3725		37.90	5/8-18	8 1/4	3 5/8	2
2-3709	*	38.50	5/8-18	9	3 5/8	2
2-3728		43.90	5/8-18	9 1/2	3 7/16	2
2-3722		48.60	5/8-18	11 1/2	3 7/16	2
2-3732		44.90	5/8-18	9 1/2	3 3/4	2
2-3724		45.80	5/8-18	10 1/2	3 3/4	2

*DESIGNATES STOCK SIZES - OTHER SIZES MADE TO ORDER

TALL NUTS FOR U-BOLTS

17-4 PH STAINLESS - MINIMUM YIELD STRENGTH IS
 110,000 PSI, MINIMUM TENSILE IS 140,000 PSI

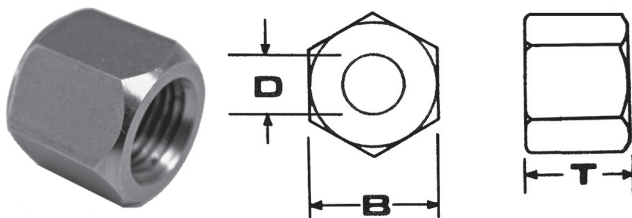

SIZE (D)	WRENCH (B)	T	PART#	\$
3/8-24	5/8	.58	2-4568	9.95
7/16-20	5/8	.58	2-4181	10.45
1/2-20	3/4	.67	2-4182	11.40
9/16-18	7/8	.75	2-4185	13.30
5/8-18	15/16*	.83	2-4183	15.40
3/4-16	1 1/16*	.98	2-4184	18.30

*B DIMENSION MAY VARY: 5/8 (7/8 OR 15/16") & 3/4-16 (1" OR 1 1/16") DEPENDING ON MATERIAL AVAILABILITY

TOLL FREE ORDER LINE : 1-800-767-4781

US HEX NUTS

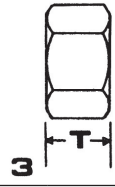
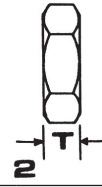
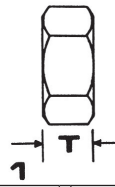
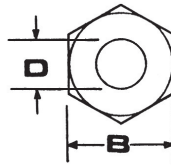

D SIZE	THDS/ INCH	B WRENCH	FULL HEX			JAM			HEAVY			HEAVY JAM			
			T1	PART#	\$	T2	PART#	\$	WRENCH	T3	PART#	\$	T2	PART#	\$
- COARSE THREAD -															
#2	56	3/16	1/16	2-4038	.05										
#4	40	1/4	3/32	2-4000	.04										
#5	40	5/16	7/64	2-4573	.05										
#6	32	5/16	7/64	2-4001	.05										
#8	32	11/32	1/8	2-4002	.06										
#10	24	3/8	1/8	2-4003	.07										
#12	24	7/16	5/32	2-4004	.08										
1/4	20	7/16	7/32	2-4005	.09	5/32	2-4024	.11	1/2	1/4	2-4101	.18	3/16	2-4511	.69
5/16	18	1/2	17/64	2-4006	.12	3/16	2-4025	.16	9/16	5/16	2-4102	.28	7/32	2-4107	.76
3/8	16	9/16	21/64	2-4007	.18	7/32	2-4026	.21	11/16	3/8	2-4103	.49	1/4	2-4108	.98
7/16	14	11/16	3/8	2-4008	.37	1/4	2-4027	.36			2-4668	1.39			
1/2	13	3/4	7/16	2-4009	.39	5/16	2-4028	.49	7/8	15/32	2-4104	.89	5/16	2-4177	1.70
9/16	12	7/8	15/32	2-4042	1.27	5/16	2-4031	1.19							
5/8	11	15/16	35/64	2-4010	.94	3/8	2-4029	.79	1 1/16	3/8	2-4105	1.89	3/8	2-4172	2.50
3/4	10	1 1/8	41/64	2-4049	1.46	7/16	2-4023	.98					7/16	2-4513	5.80
7/8	9	1 5/16	23/32	2-4186	1.25										
1	8	1 1/2	55/64	2-4146	3.96	25/46	2-4022	2.10							
- FINE THREAD -															
#4	48	1/4	3/32	2-4011	.10										
#6	40	5/16	7/64	2-4012	.18										
#8	36	11/32	1/8	2-4013	.18										
#10	32	3/8	1/8	2-4014	.07										
1/4	28	7/16	7/32	2-4016	.11	5/32	2-4032	.11	1/2	1/4	2-4147	.19			
5/16	24	1/2	17/64	2-4017	.15	3/16	2-4033	.18	9/16	5/16	2-4148	.49	7/32	2-4115	.82
3/8	24	9/16	21/64	2-4018	.21	7/32	2-4034	.21	11/16	5/8	2-4158	.79			
7/16	20	11/16	3/8	2-4019	.44	1/4	2-4035	.39							
1/2	20	3/4	7/16	2-4020	.54	5/16	2-4036	.49	7/8	15/32	2-4670	1.48			
9/16	18	7/8	31/64	2-4015	1.28	5/16	2-4030	1.44							
5/8	18	15/16	35/64	2-4021	1.26	3/8	2-4037	.98							
11/16	16	15/16				3/8	2-4173	4.90							
11/16	18	1 1/16				3/8	2-4514	6.90							
3/4	16	1 1/8	41/64	2-4197	1.69	7/16	2-4050	1.39							
7/8	14	1 5/16	23/32	2-4586	1.88	1/2	2-4189	1.90							
7/8	16	1 1/4				7/16	2-4516*	8.90							
7/8	20	1 1/4				7/16	2-4593	9.80							
1	14	1 1/2	55/64	2-4051	3.99	9/16	2-4110	2.10							

* JAM NUT FOR 55-57 STEERING ARM *

SHOP ASSORTMENT: HEX & JAM NUTS - COARSE & FINE THREAD - 1425 PC - 24 COMPARTMENT: 3-3079 \$309.00

QUANTITY DISCOUNTS: 20% off of 100 of any one size of fastener, 30% off of 500, 36% of 1000. Call for quotes on larger quantities. Quantity discounts above the 100 piece level do not apply to all items.

WHOLESALE: Interested in resale of our products? Call for more information on dealer discounts!

US ACORN NUTS

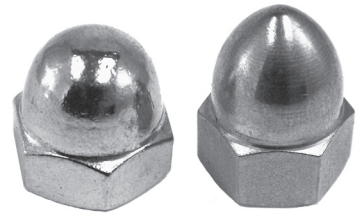
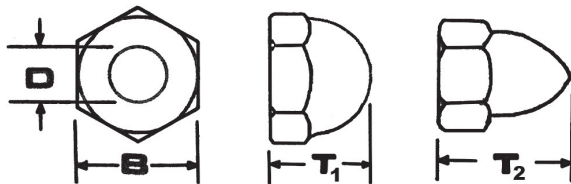

D (SIZE)	THDS/ INCH	B WRENCH	ACORN			HIGH CROWN			
			T1	PART#	\$	WRENCH	T2	PART#	\$
- COARSE THREAD -									
#6	32	5/16	11/32	2-4039	.28				
#8	32	11/32	11/32	2-4040	.29				
#10	24	3/8	13/32	2-4041	.30	3/8	33/64	2-4090	1.39
#12	24	3/8	13/32	2-4099	.98				
1/4	20	7/16	15/32	2-4043	.39	7/16	19/32	2-4091	1.46
5/16	18	9/16	17/32	2-4044	.68	1/2	11/16	2-4092	1.90
3/8	16	5/8	5/8	2-4045	.89	9/16	25/32	2-4093	2.70
7/16	14	5/8	11/16	2-4046	2.49	5/8	7/8	2-4094	3.95
1/2	13	3/4	13/16	2-4047	1.49	3/4	1 1/32	2-4095	5.75
5/8	11	1	1	2-4048	4.80				
- FINE THREAD -									
#10	32	3/8	13/32	2-4052	.30	3/8	33/64	2-4190	1.39
1/4	28	7/16	15/32	2-4053	.48	7/16	19/32	2-4191	1.46
5/16	24	9/16	17/32	2-4054	.89	1/2	11/16	2-4192	1.90
3/8	24	5/8	5/8	2-4055	.98	9/16	25/32	2-4193	2.70
7/16	20	5/8	11/16	2-4056	3.75	5/8	7/8	2-4194	3.95
1/2	20	3/4	13/16	2-4057	1.99	3/4	1 1/32	2-4195	5.75
9/16	18	7/8	7/8	2-4165	14.90				
5/8	18	1	1	2-4058	7.90	15/16	1 5/16	2-4196	11.80
3/4	16	1 1/8	1 3/16	2-4162	16.75	1 1/16	1 1/2	2-4175	18.90

ADDITIONAL SIZES:

- 4-40 ACORN NUT
2-4198 \$.49
- 9/16-12 ACORN NUT
2-4199 \$ 14.90
- 7/8-14 ACORN NUT
2-4176 \$ 24.80

- COARSE THREAD NUT ASSORTMENT: 1010 PIECES

- INCLUDES HEX, ACORN, NYLON, & WING NUTS
- # 3-3010 \$ 260.00
- 10-24 THRU 3/8-16

- FINE THREAD NUT ASSORTMENT: 1245 PIECES

- INCLUDES HEX, JAM, ACORN, NYLON & WING NUTS
- # 3-3022 \$ 271.50
- 10-32 THRU 3/8-24

SERRATED FLANGE

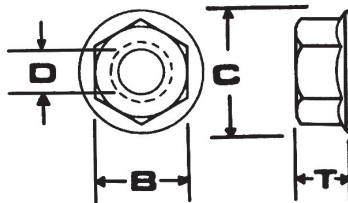

KEP

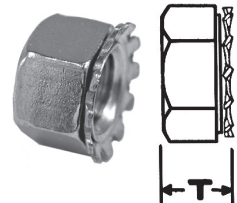

WING NUTS

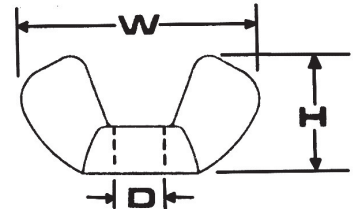

D (SIZE)	THDS/ INCH	B WRENCH	SERRATED FLANGE NUTS				KEP NUTS			WING NUTS			
			C	T1	PART#	\$	T2	PART#	\$	W	H	PART#	\$
#4	40	1/4					1/8	2-4178	.06				
#6	32	5/16	13/32	5/32	2-4164	.13	9/64	2-4128	.07	.61	23/64	2-4136	.28
#8	32	11/32	15/32	3/16	2-4121	.13	5/32	2-4129	.09	.81	13/32	2-4137	.32
#10	24	3/8	1/2	13/64	2-4122	.14	5/32	2-4130	.11	.81	13/32	2-4138	.33
#10	32	3/8	1/2	13/64	2-4123	.14	5/32	2-4131	.11	.81	13/32	2-4139	.33
#12	24				2-4518	.34							
1/4	20	7/16	19/32	7/32	2-4124	.19	15/64	2-4132	.17	1.03	17/32	2-4140	.36
1/4	28	7/16	19/32	7/32	2-4127	.45				1.03	17/32	2-4645	.59
5/16	18	1/2	11/16	9/32	2-4125	.47	21/64	2-4133	.28	1.13	19/32	2-4141	.49
5/16	24	1/2	11/16	9/32	2-4169	.49				1.13	19/32	2-4646	.75
3/8	16	9/16	3/4	11/32	2-4126	.35	9/16	2-4134	.39	1.39	25/32	2-4142	.69
3/8	24	9/16	3/4	11/32	2-4170	.84				1.39	25/32	2-4647	1.19
1/2	13	3/4	1 1/32	7/16	2-4171	.89				1.89	1	2-4143	1.49

SPECIALTY NUTS

COUPLING NUTS

*** LOW STRENGTH ***

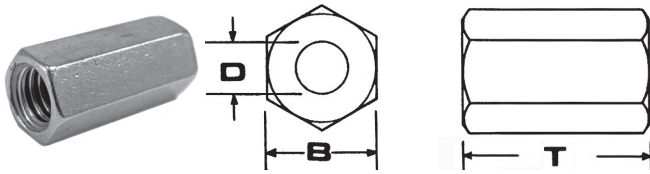

COARSE THREAD				
SIZE (D)	WRENCH (B)	T	PART#	\$
8-32	5/16	1/2	2-4555	2.10
10-24	3/8	3/4	2-4537	2.10
1/4-20	3/8	7/8	2-4538	2.25
5/16-18	7/16	1	2-4539	2.30
3/8-16	1/2	1-1/8	2-4540	2.50
7/16-14	9/16	1-1/4	2-4556	4.73
1/2-13	5/8	1-1/4	2-4557	4.75

FINE THREAD				
SIZE (D)	WRENCH (B)	T	PART#	\$
10-32	5/16	3/4	2-4560	2.10
1/4-28	3/8	7/8	2-4545	2.15
5/16-24	7/16	1	2-4546	2.75
3/8-24	1/2	1-1/8	2-4547	3.25
7/16-20	9/16	1-1/4	2-4548	7.90
1/2-20	5/8	1-1/4	2-4549	4.84

TWELVE POINT NUTS

- HIGH STRENGTH -

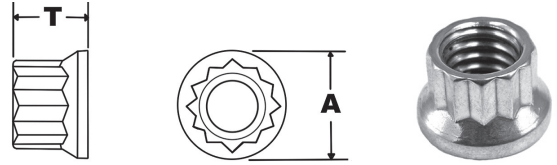

COARSE THREAD					
SIZE	WRENCH	T	A	PART#	\$
1/4-20	5/16	5/16	.43	2-4581	6.52
5/16-18	3/8	11/32	.54	2-4582	6.64
3/8-16	7/16	13/32	.63	2-4583	6.76
7/16-14	1/2	7/16	.69	2-4584	7.12
1/2-13	9/16	1/2	.82	2-4585	9.61

FINE THREAD					
SIZE	WRENCH	T	A	PART#	\$
1/4-28	5/16	5/16	.43	2-4168	6.52
5/16-24	3/8	11/32	.54	2-4149	6.64
3/8-24	7/16	13/32	.63	2-4150	6.76
7/16-20	1/2	7/16	.69	2-4188	7.12
1/2-20	9/16	1/2	.82	2-4589	9.61

TEE NUTS

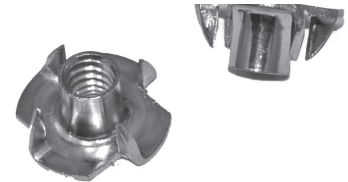

SIZE	B	T	PART #	\$
10-24	.74	.30	2-4561	.59
10-32	.74	.30	2-4571	.78
1/4-20	.75	.35	2-4562	.79
5/16-18	.88	.39	2-4563	.87
3/8-16	1.0	.48	2-4564	.99

LEFT HAND THREAD NUTS

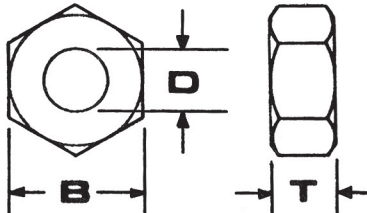

- FINE THREAD -								
D (SIZE)	THDS /INCH	B WRENCH	FULL HEX			JAM		
			T1	PART#	\$	T2	PART#	\$
10	32	3/8	1/8	2-4608	4.90			
1/4	28	7/16	7/32	2-4609	.28	5/32	2-4629	.96
5/16	24	1/2	17/64	2-4611	.59	3/16	2-4631	1.28
3/8	24	9/16	21/64	2-4613	1.20	7/32	2-4633	1.99
7/16	20	11/16	3/8	2-4615	4.49	1/4	2-4634	4.98
1/2	20	3/4	7/16	2-4617	1.95	5/16	2-4621	2.76
9/16	18	7/8	15/32	2-4624	4.99	5/16	2-4622	5.90
5/8	18	15/16	35/64	2-4637	5.50	3/8	2-4642	11.90
11/16	18 *	1 1/16	5/8	2-4627	8.99	3/8	2-4644	11.90
3/4	16	1 1/8	41/64	2-4623	5.95	3/8	2-4643	11.90

*** TIE ROD NUT FOR OLD FORDS- RIGHT HAND NUT IS #2-4514 \$7.90**
WE CUSTOM MAKE THE LARGER SQUARE NUTS IN OUR SHOP FROM BAR STOCK - WE STOCK 5/8" THRU 1" STOCK - YOU SPECIFY THREAD TYPE & THICKNESS.

TOLL FREE ORDER LINE : 1-800-767-4781

US SQUARE NUTS

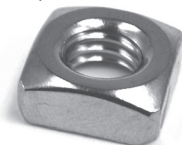

SIZE	WRENCH	T	PART#	\$
6-32	5/16	3/32	2-4587	.15
8-32	11/32	1/8	2-4159	.16
10-24	3/8	1/8	2-4152	.19
10-32	3/8	1/8	2-4153	.28
1/4-20	7/16	3/16	2-4154	.29
5/16-18	9/16	7/32	2-4155	.39
3/8-16	5/8	1/4	2-4156	.69
7/16-14	3/4	3/8	2-4578	7.90
7/16-14	7/8	7/16	2-4580	9.80
1/2-13	7/8	7/16	2-4579	9.90

HIGH STRENGTH US HEX NUTS

MADE IN OUR SHOP - 17-4 PH
110,000 MIN YIELD STRENGTH
THESE CAN BE MADE TO ANY THICKNESS

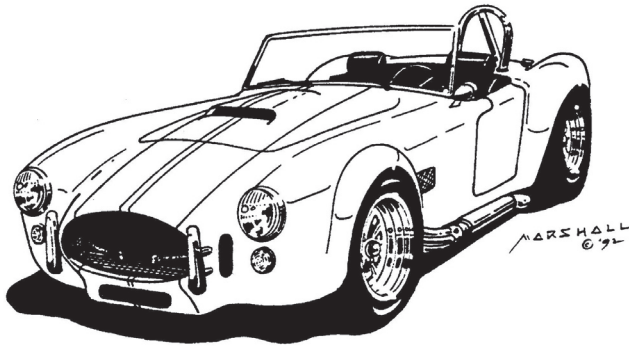
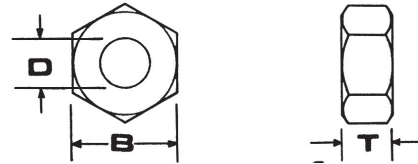

SIZE (D)	WRENCH (B)	T	PART#	\$
3/8-16	5/8	7/16	2-4522	8.79
3/8-24	5/8	7/16	2-4672	8.88
7/16-14	5/8	7/16	2-4517	8.93
7/16-20	5/8	7/16	2-4673	8.98
1/2-13	3/4	1/2	2-4567	10.69
1/2-20	3/4	1/2	2-4674	10.77
9/16-12	7/8	9/16	2-4519	12.49
9/16-18	7/8	9/16	2-4675	12.55
5/8-11	7/8*	5/8	2-4520	13.36
5/8-18	7/8*	7/16	2-4671	13.56
5/8-18	7/8*	5/8	2-4676	13.64
3/4-10	1*	11/16	2-4588	17.69
3/4-16	1*	11/16	2-4677	17.87

*B DIMENSION MAY VARY: 5/8 (7/8 OR 15/16")
& 3/4-16 (1" OR 1 1/16") DEPENDING ON
MATERIAL AVAILABILITY

SMALL PATTERN NUTS

- STANDARD SERRATED FLANGE NUTS ON ON THE NEXT PAGE -

SIX POINT NUTS (18-8 LOW STRENGTH)

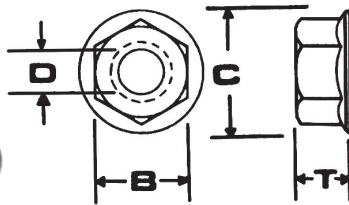

18-8 SS (LOW STRENGTH) DRILLED & TAPPED IN OUR SHOP

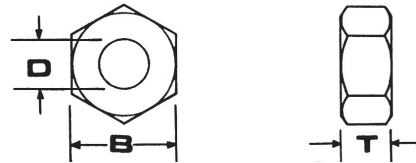

D (SIZE)	THDS/ INCH	B WRENCH	SERRATED FLANGE NUTS			
			C	T1	PART#	\$
#10	24	5/16	19/32	5/32	2-4678	2.64
#10	32	5/16	19/32	5/32	2-4679	2.64
1/4	20	3/8	1/2	13/64	2-4680	2.69
1/4	28	3/8	1/2	13/64	2-4681	2.69
5/16	18	7/16	19.32	7/32	2-4682	2.98
5/16	24	7/16	19.32	7/32	2-4683	2.98
3/8	16	7/16	19/32	7/32	2-4684	2.99
3/8	24	7/16	19/32	7/32	2-4685	2.99
7/16	14	1/2	11/16	9/32	2-4686	3.46
7/16	20	1/2	11/16	9/32	2-4687	3.46
1/2	13	9/16	3/4	11/32	2-4688	3.98
1/2	20	9/16	3/4	11/32	2-4689	3.98
9/16	12	17MM	13/16	13/32	2-4690	4.59
9/16	18	17MM	13/16	13/32	2-4691	4.59
5/8	11	3/4	1 1/32	7/16	2-4693	4.98
5/8	18	3/4	1 1/32	7/16	2-4694	4.98

D SIZE	THDS/ INCH	B WRENCH	HEX NUTS		
			T	PART#	\$
# 10	24	5/16	7/64	2-4649	3.79
# 10	32	5/16	7/64	2-4663	3.83
1/4	20	3/8	1/8	2-4666	3.85
1/4	28	3/8	1/8	2-4655	3.85
5/16	18	7/16	5/32	2-4570	4.89
5/16	18	7/16	7/32	2-4656	4.87
5/16	24	7/16	5/32	2-4657	4.89
5/16	24	7/16	7/32	2-4658	4.87
3/8	16	1/2	3/16	2-4659	4.96
3/8	16	1/2	17/64	2-4660	4.93
3/8	24	1/2	3/16	2-4661	4.96
3/8	24	1/2	17/64	2-4662	4.93

TOLL FREE ORDER LINE : 1-800-767-4781

CASTLE & SLOTTED HEX NUTS

HIGH STRENGTH SLOTTED TALL NUTS - MADE IN USA - COMMONLY CALLED "CASTLE NUTS" - USE THESE ON SUSPENSION PARTS (BALL JOINTS, TIE ROD ENDS, IDLER ARMS, ETC.)

7/16, 1/2, 9/16, 5/8 SIZES ARE 17-4 PH STAINLESS WITH A MINIMUM OF 110,000 YIELD STRENGTH
 3/4" IS 304 STAINLESS WITH A MINIMUM 70,000 YIELD STRENGTH

SIZE	B WRENCH	C COTTER KEY SIZE	PART#	\$
7/16-20	5/8	1/8 X 1-1/4 2-5015	2-4523	14.10
1/2-20	3/4	5/32x 1-1/4 2-5022	2-4525	16.40
9/16-18	7/8	5/32 X 1-1/2 2-5023	2-4527	19.37
5/8-18	15/16*	3/16 X 1-1/2 2-5029	2-4531	22.25
11/16	1-1/16*	3/16 X 1 1/2 2-5029	2-4536	24.25
3/4-16	1 1/8*	3/16 X 2 2-5030	2-4533	26.78

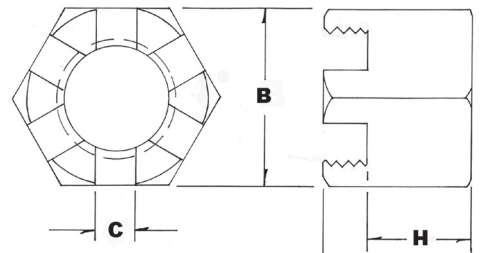
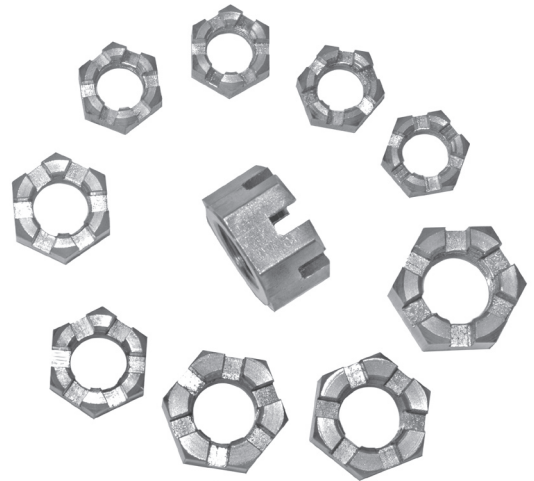

*B DIMENSION MAY VARY: 5/8 (7/8 OR 15/16"), 11/16 (1 OR 1-1/16") & 3/4-16 (1-1/8 OR 1-1/16") DEPENDING ON MATERIAL AVAILABILITY

- WE MACHINE THE HEIGHT TO MATCH YOUR NEEDS - SPECIFY DISTANCE FROM BOTTOM OF NUT TO BOTTOM OF SLOTS (H) -

LOW STRENGTH 18-8 CASTLE NUTS - NOT FOR USE ON SUSPENSIONS - STATE APPLICATION WHEN ORDERING 7/16 & 1/2" SIZES



THE KIT FOR A MODEL - A TAILGATE (SHOWN ABOVE) USES 1/2-20 CASTLE NUTS THIS IS A TYPICAL LOW STRENGTH APPLICATION WHERE 18-8 CASTLE NUTS CAN BE USED

**TOLL FREE ORDER LINE:
 1-800-767-4781**

COARSE THREAD				
SIZE	WRENCH (B)	PART#	\$	COTTER
10-24	3/8	2-4569	4.54	1/16 X 3X4
1/4-20	7/16	2-4541	4.68	1/16 X 1
5/16-18	1/2	2-4542	4.76	3/32 X 1
3/8-16	9/16	2-4543	5.67	1/8 X 1
7/16-14	5/8	2-4544	7.75	1/8 X 1 1/4
1/2-13	3/4	2-4559	7.90	5/32 X 1 1/4

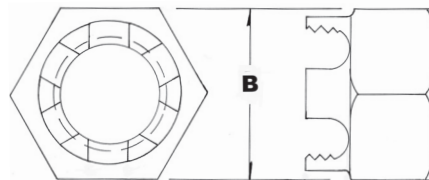

FINE THREAD				
SIZE	WRENCH (B)	PART#	\$	COTTER
10-32	3/8	2-4550	4.54	1/16 X 3X4
1/4-28	7/16	2-4551	4.69	1/16 X 1
5/16-24	1/2	2-4552	4.96	3/32 X 1
3/8-24	9/16	2-4553	5.98	1/8 X 1
7/16-20	5/8	2-4554	7.96	1/8 X 1 1/4
1/2-20	3/4	2-4521	8.80	5/32 X 1 1/4

NYLON INSERT LOCK NUTS

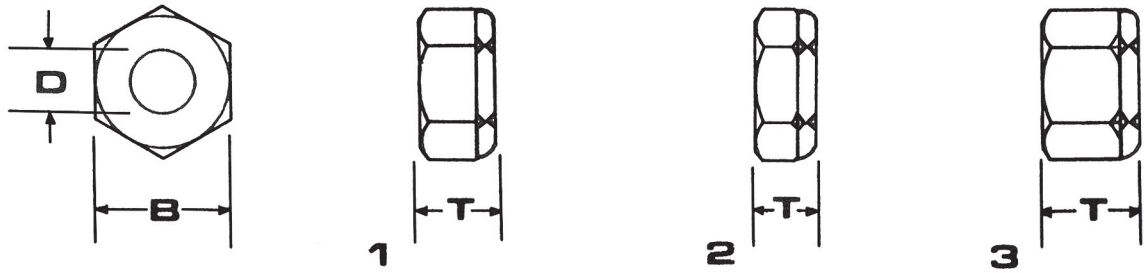

D (SIZE)	THDS/ INCH	B WRENCH	STD W/ NYLON INSERT			THIN W/ NYLON INSERT			HEAVY W/ NYLON INSERT			
			T1	PART#	\$	T2	PART#	\$	WRENCH	T3	PART#	\$
#4	40	1/4	9/64	2-4060	.06	7/64	2-4075	.14				
#5	40	1/4	9/64	2-4590	.08							
#6	32	5/16	11/64	2-4061	.07	1/8	2-4076	.12				
#8	32	11/32	15/64	2-4062	.08	11/64	2-4077	.13				
#10	24	3/8	15/64	2-4063	.10	11/64	2-4078	.11				
#12	24	7/16	5/16	2-4100	.25							
1/4	20	7/16	5/16	2-4064	.15	13/64	2-4079	.18	1/2	3/8	2-4111	.59
5/16	18	1/2	11/32	2-4065	.19	1/4	2-4080	.23	9/16	7/16	2-4112	1.25
3/8	16	9/16	29/64	2-4066	.29	17/64	2-4081	.34	11/16	17/32	2-4113	1.96
7/16	14	5/8	15/32	2-4059	.39	19/64	2-4083	1.59	3/4	5/8	2-4515	3.97
1/2	13	3/4	19/32	2-4067	.75	5/16	2-4082	1.18	7/8	7/8	2-4114	2.99
9/16	12	7/8	5/8	2-4109	2.60	3/8	2-4116	4.70				
5/8	11	15/16	3/4	2-4068	1.29	3/8	2-4096	2.90				
3/4	10	1 1/8	7/8	2-4097	2.49	13/32	2-4166	8.90				
1	8	1 7/16	1 1/16	2-4135	5.75	9/16	2-4144	9.80				
- FINE THREAD -												
#10	32	3/8	15/64	2-4069	.11	11/64	2-4084	.11				
1/4	28	7/16	5/16	2-4070	.16	13/64	2-4085	.19				
5/16	24	1/2	11/32	2-4071	.21	1/4	2-4086	.25				
3/8	24	9/16	29/64	2-4072	.34	17/64	2-4087	.39				
7/16	20	5/8	15/32	2-4118	.48	19/64	2-4117	1.49				
1/2	20	3/4	19/32	2-4073	.79	5/16	2-4088	1.29				
9/16	18	7/8	5/8	2-4120	3.90	11/32	2-4098	4.70				
5/8	18	15/16	3/4	2-4074	1.49	3/8	2-4089	3.60				
3/4	16	1 1/8	7/8	2-4157	2.95	13/32	2-4119	9.49				
1	14	1 7/16	1 1/16	2-4145	13.95	9/16	2-4151	11.49				

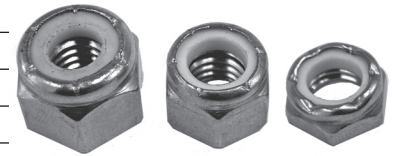

NYLON INSERT LOCK NUT SHOP ASSORTMENT: 1460 PIECES # 3-3037 \$ 270.50 #6 THRU 1/2"

AIR CLEANER NUTS

POLISHED

SIZE	O.D.	PART #	\$
1/4-20	1"	2-4565	14.35
	1 1/4	2-4501	16.25
5/16-18	1"	2-4566	14.75
	1 1/4	2-4503	16.25.



NOTE: MOST CARBS HAVE A 1/4-20 STUD

TOLL FREE ORDER LINE : 1-800-767-4781



US WASHERS

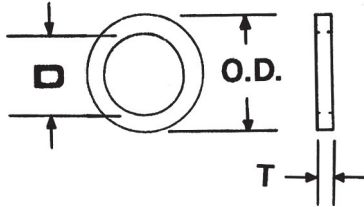

SIZE	NAME	I.D	O.D	T	PART#	\$
#4	MS803	.125	.250	.020	2-4260	.03
	MS804	.125	.310	.022	2-4224	.03
	#4 STAND	.125	.315	.020	2-4212	.03
	#4 AN	.125	.315	.023	2-4200	.03
	3MM SMALL	.132	.225	.016	1-2000	.03
	3MM STAND	.132	.275	.018	1-2008	.03
	3MM LARGE	.132	.345	.027	1-2016	.03
	#6	MS805	.156	.316	.030	2-4261
#6 STAND		.156	.375	.024	2-4213	.03
#6 FENDER		.156	.625	.030	2-4299	.06
MS806		.168	.375	.041	2-4225	.03
#8	#8 STAND	.172	.375	.025	2-4214	.03
	4MM SMALL	.175	.315	.019	1-2001	.05
	4MM STAND	.175	.350	.030	1-2009	.03
	4MM LARGE	.175	.465	.037	1-2017	.05
	#8 FENDER	.175	.75	.045	2-4286	.08
	#8 AN	.178	.375	.032	2-4202	.03
#10	MS807	.187	.375	.040	2-4226	.03
	#10 FENDER	.205	.687	.045	2-4236	.08
	#10 FENDER	.205	.75	.045	2-4717	.11
	#10 FENDER	.205	1.00	.045	2-4237	.13
	#10 AN	.207	.438	.060	2-4203	.03
	5MM SMALL	.215	.346	.035	1-2002	.05
	5MM STAND	.215	.390	.035	1-2010	.03
	5MM LARGE	.215	.590	.037	1-2018	.07
	MS808	.217	.438	.037	2-4262	.03
#12	#12 X .59	.22	.59	.037	2-4990	.97
	#12 FENDER	.22	1.00	.045	2-4991	1.10
	#12 STAND	.245	.50	.040	2-4216	.05
1/4	6MM SMALL	.255	.433	.055	1-2003	.05
	6MM STAND	.255	.475	.055	1-2011	.04
	MS809	.255	.560	.055	2-4227	.06
	6MM LARGE	.255	.70	.055	1-2019	.12
	1/4 HEAVY	.255	.75	.070	2-4277	.27
	1/4 AN	.265	.50	.060	2-4205	.04
	MS810	.280	.625	.062	2-4263	.05
	1/4 STAND	.285	.630	.040	2-4217	.05
	1/4 FENDER	.285	.688	.05	2-7497	.17
	1/4 FENDER	.285	1.00	.045	2-4238	.15
	1/4 FENDER	.285	1.25	.045	2-4239	.24
	1/4 FENDER	.285	1.50	.045	2-4240	.33

SIZE	NAME	I.D.	O.D.	T	PART#	\$
5/16	8MM CLEVIS	.312	.630	.079	1-2033	.18
	MS811	.320	.730	.055	2-4229	.09
	5/16 HEAVY	.325	.850	.085	2-4248	.38
	5/16 AN	.330	.565	.055	2-4206	.05
	8MM SMALL	.335	.578	.055	1-2004	.06
	8MM STAND	.335	.620	.055	1-2012	.06
	5/16 STAND	.340	.750	.050	2-4218	.06
	8MM LARGE	.340	.935	.075	1-2020	.25
	MS812	.345	.685	.055	2-4264	.06
	5/16 FENDER	.345	1.25	.050	2-4287	.24
5/16 FENDER	.345	1.50	.050	2-4241	.33	
3/8	MS813	.375	.875	.075	2-4230	.14
	3/8 SPL	.378	.720	.105	2-4786	.79
	INT/EXH	.380	1.25	.312	2-4425	4.50
	RKT INT	.380	1.35	.25	2-4428	4.90
	SBC INTAKE	.390	.675	.120	2-4211	.37
	3/8 HINGE	.390	1.00	.120	2-4245	.75
	EXTRA HEAVY	.390	1.50	.120	2-4249	5.99
	10MM CLEVIS	.394	.810	.098	1-2034	.29
	3/8 AN	.395	.630	.055	2-4207	.06
	MS814	.400	.815	.055	2-4265	.07
	3/8 FENDER	.400	1.50	.050	2-4242	.33
	3/8 STAND	.410	.875	.050	2-4219	.08
	10MM SMALL	.415	.695	.055	1-2005	.13
	10MM STAND	.415	.780	.075	1-2013	.13
10MM LARGE	.420	1.17	.090	1-2021	.39	
7/16	7/16 HEAVY	.438	1.17	.090	2-4423	2.39
	7/16 SPACER	.438	1.50	.050	2-4973	4.49
	EXTRA HVY	.438	1.50	.120	2-4492	3.49
	MS815	.440	1.00	.065	2-4231	.19
	ARP HEAD	.450	.810	.120	2-4417	3.10
	7/16 AN	.455	.750	.055	2-4208	.09
	MS816	.470	.920	.055	2-4266	.11
	12MM CLEVIS	.474	1.00	.120	1-2035	.39
	7/16 STAND	.495	1.12	.060	2-4220	.18
	1/2	1/2 SPL	.502	1.00	.120	2-4710
1/2 HEAVY		.502	1.17	.090	2-4940	1.39
1/2 SPACER		.502	1.50	.050	2-4994	4.49
EXTRA HEAVY		.502	1.50	.120	2-4907	5.89
12MM SMALL		.510	.815	.075	1-2006	.18
12MM STAND		.510	.945	.085	1-2014	.19
MS817		.510	1.26	.075	2-4232	.23
12MM LARGE		.510	1.42	.092	1-2022	.59
1/2 AN		.515	.875	.055	2-4209	.11
1/2 STAND		.530	1.26	.060	2-4221	.19
MS818		.540	1.06	.075	2-4267	.21
1/2 FENDER		.560	2.00	.06	2-4243	.59

SHOP ASSORTMENTS: 1705 PIECES #3-3009 \$ 150.00
 2250 PIECES 3-3066 173.00

PERSONAL ASSORTMENT: 1200 PC. #3-3200 89.00

QUANTITY DISCOUNTS: 20% off of 100 of any one size of fastener, 30% off of 500, 36% of 1000. Call for quotes on larger quantities. Quantity discounts above the 100 piece level do not apply to all items.

US WASHERS

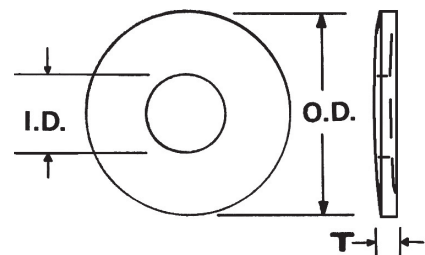
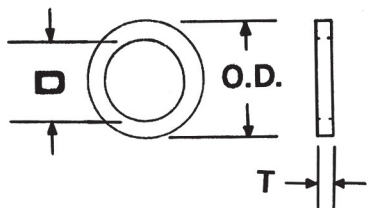

SIZE	NAME	I.D.	O.D.	T	PART#	\$
9/16	MS819	.57	1.37	.100	2-4233	.39
	9/16 STAND	.58	1.06	.07	2-7496	.29
	9/16 AN	.59	1.06	.060	2-4204	.19
	14MM STAND	.59	1.10	.100	1-2025	.29
	14MM LARGE	.59	1.73	.120	1-2026	.99
5/8	5/8 AN	.64	1.18	.060	2-4210	.29
	16MM SMALL	.68	1.08	.093	1-2007	.36
	16MM STAND	.68	1.17	.115	1-2015	.34
	MS820	.69	1.31	.08	2-4268	.32
	5/8 STAND	.69	1.55	.075	2-4222	.39
	16MM LARGE	.69	1.97	.115	1-2023	1.24
	MS821	.71	1.75	.120	2-4234	.85
3/4	3/4 AN	.78	1.31	.085	2-4235	.45
	3/4 STAND	.82	1.74	.105	2-4223	.50
	MS822	.83	1.50	.115	2-4228	.59
	20MM LARGE	.86	2.35	.16	1-2028	1.99
7/8	7/8 STAND	.94	2.00	.12	2-4439	.64
1	1" AN	1.03	1.75	.105	2-4409	.58
	MS826	1.06	1.97	.11	2-4275	.91
1 1/4	1 1/4" STAND	1.35	2.75	.12	2-4421	1.78

WASHERS FOR BODY MOUNTS, SHOCKS, SUSPENSION BUSHINGS, ETC - LET US KNOW IF YOU WANT THEM DISHED -

SIZE	NAME	I.D.	O.D.	T	PART#	\$
3/8	SHOCK	.39	1.44	.120	2-4438	5.50
3/8	BODY MOUNT	.39	1.81	.120	2-4276	8.75
3/8	BODY MOUNT	.39	2.04	.120	2-4289	6.25
3/8	SWAY BAR	.41	1.17	.090	2-4713	5.50
7/16	STRIKER	.44	1.44	.120	2-4427	8.75
7/16	BODY MOUNT	.44	1.81	.120	2-4285	8.75
7/16	BODY MOUNT	.44	2.04	.120	2-4279	7.50
7/16	BODY MOUNT	.44	2.21	.105	2-4401	8.99
1/2	STRIKER	.50	1.44	.120	2-4479	8.50
1/2	BODY MOUNT	.50	1.81	.120	2-4402	8.99
1/2	BODY MOUNT	.50	2.04	.120	2-4403	9.50
1/2	BODY MOUNT	.50	2.21	.105	2-4288	9.50
9/16	BODY MOUNT	.57	2.21	.105	2-4406	9.50
5/8	5/8 HEAVY	.63	1.44	.120	2-4488	10.50
5/8	BODY MOUNT	.63	1.81	.120	2-4415	10.99
5/8	BODY MOUNT	.63	2.21	.105	2-4416	10.99

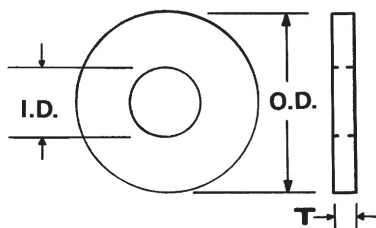

HARMONIC BALANCER WASHERS

SIZE	FOR:	I.D.	O.D.	T	PART#	\$
7/16	SBC	.438	1.75	.31	2-4450	14.30
7/16	FORD MOD	.484	1.50	.25	2-4712	13.20
1/2	331/390 CAD	.502	1.39	.28	2-4464	13.45
1/2	AMC	.502	1.75	.30	2-4453	14.40
1/2	ROCKET	.502	1.75	.31	2-4490	14.45
1/2	BBC	.502	2.00	.31	2-4451	17.19
9/16	250 FORD ST6	.564	1.75	.25	2-4906	14.45
9/16	472/500 CAD	.564	2.00	.25	2-4471	16.30
5/8	PONTIAC	.630	1.62	.30	2-4473	15.10
5/8	215 BUICK	.630	1.75	.30	2-4474	14.40
5/8	SBF	.630	1.75	.19	2-4472	14.10
5/8	FE/BBF	.630	2.00	.31	2-4468	18.00
3/4	455 BUICK	.755	1.69	.38	2-4487	17.20
3/4	260/455 OLDS	.755	1.87	.32	2-4979	18.10
3/4	EARLY HEMI	.755	2.00	.25	2-4980	17.30
3/4	BBM/426 HEMI	.755	1.75	.38	2-4996	15.40

HEAD BOLT WASHERS HARDENED 17-4 PH

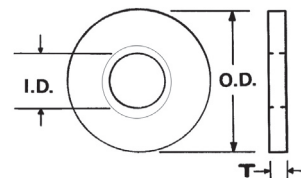

ID	OD	T	PART #	\$
7/16	.810	.120	2-4417	3.50
1/2	.870	.150	2-4215	5.50
9/16	1.00	.180	2-4486	6.25

D SHAPED WASHERS

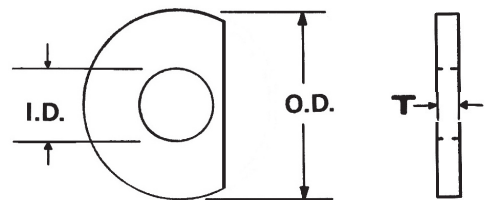

ID	OD	T	PART #	\$
1/4	1 1/4	.045	2-4426	2.89
3/8	1 3/16	.09	2-4418	2.98
7/16	1 3/16	.09	2-4410	3.49
9/16	1 3/8	.10	2-4998	3.68

TOLL FREE ORDER LINE : 1-800-767-4781

SPACERS - MADE IN USA

3/8" I.D. X .54 O.D.

SWAY BAR SPACERS

WE USE THESE IN OUR SUSPENSION KITS

LENGTH	PART#	\$
9/16	2-4459	4.00
11/16	2-6203	4.10
15/16	2-6201	4.17
1	2-6280	4.19
1 1/4	2-6209	4.62
1 1/2	2-4575	4.73
1 3/4	2-4576	4.83
2	2-4504	4.94
2 1/4	2-4505	5.00
2 1/2	2-4506	5.15
2 3/4	2-4507	5.46
3	2-4508	5.78
3 1/4	2-4510	6.00
3 1/2	2-4577	6.29
4	2-6284	6.83
4 1/2	2-6285	7.77
5	2-6286	8.38
5 1/2	2-6283	8.86
6	2-6288	9.42
6 1/2	2-6289	9.96
6 7/8	2-4597	10.40

5/8" O.D. ACCESSORY SPACERS

SIZE:	1/4 ID		5/16 ID		3/8 ID	
LENGTH	PART#	\$	PART#	\$	PART#	\$
1/4	2-4720	5.20	2-4730	5.22	2-4483	5.24
3/8	2-4721	5.73	2-4731	6.74	2-4741	6.76
1/2	2-4722	6.23	2-4434	7.18	2-4742	7.22
5/8	2-4723	6.78	2-4733	7.60	2-4743	7.64
3/4	2-4724	7.26	2-4734	7.92	2-4744	7.96
1	2-4726	8.28	2-4736	8.30	2-4746	8.39
1 1/4	2-6211	9.31	2-6213	9.39	2-6215	9.44
1 1/2			2-6214	10.45	2-6216	10.49

3/4" O.D. ACCESSORY SPACERS

JUST THE TRICK FOR ALIGNING BRACKETS ON YOUR STREET ROD!

SIZE:	1/4 ID		5/16 ID		3/8 ID		7/16 ID		1/2 ID	
LENGTH	PART#	\$	PART#	\$	PART#	\$	PART#	\$	PART#	\$
1/4	2-4430	6.18	2-4443	6.22	2-4440	6.24	2-4446	6.27	2-4452	6.29
3/8	2-4728	6.85	2-4748	6.88	2-4752	6.90	2-4758	6.91	2-4765	6.92
1/2	2-4431	7.23	2-4444	7.27	2-4441	7.29	2-4447	7.32	2-4766	7.34
5/8	2-4729	7.85	2-4749	7.89	2-4753	7.92	2-4759	7.95	2-4462	7.97
3/4	2-4738	8.28	2-4463	8.32	2-4754	8.34	2-4760	8.37	2-4454	8.39
1	2-4432	9.33	2-4445	9.19	2-4442	9.39	2-4448	9.42	2-4455	9.44
1 1/4	2-4739	10.38	2-4750	10.42	2-4755	10.44	2-4761	10.47	2-4767	10.40
1 1/2			2-6218	11.47	2-4756	11.49	2-4762	11.52	2-4768	11.54

1" O.D. SPACERS

SIZE:	7/16 ID		1/2 ID		9/16 ID		5/8 ID	
LENGTH	PART#	\$	PART#	\$	PART#	\$	PART#	\$
1/4	2-4770	8.18	2-4711	8.39	2-4784	8.86	2-6208	9.44
3/8	2-6219	9.12	2-6221	9.41	2-6223	9.73	2-6287	10.10
1/2	2-4771	9.44	2-4778	9.81	2-4785	10.16	2-6210	10.70
5/8	2-4772	10.00	2-4779	10.42	2-6270	10.87	2-6273	11.20
3/4	2-4773	10.66	2-4780	10.98	2-4787	11.33	2-6212	11.91
1	2-4774	11.84	2-4781	12.27	2-6271	12.59	2-6274	13.11
1 1/4	2-4775	12.99	2-4782	13.42	2-6272	13.88	2-6275	14.35
1 1/2	2-4776	14.21	2-4783	14.58	2-4719	15.16	2-6276	15.57
2	2-6220	15.42	2-6222	15.74	2-6224	16.37	2-6277	16.79

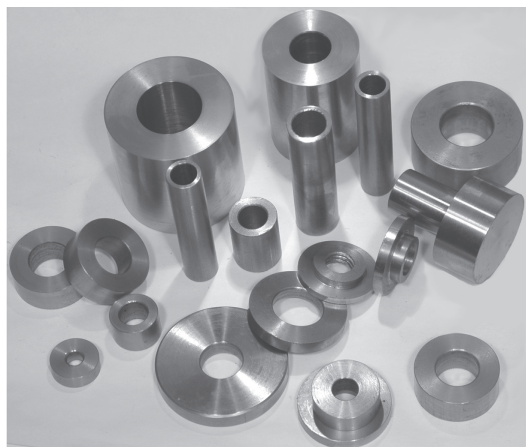

1 1/4" O.D. SPACERS

SIZE:	7/16 ID		1/2 ID		9/16 ID		5/8 ID		3/4 ID	
LENGTH			PART#	\$			PART#	\$	PART#	\$
1/4	2-4929	10.38	2-4900	10.96	2-6232	11.50	2-4908	12.05	2-4916	12.58
3/8	2-6225	11.10	2-4922	11.50	2-6233	12.20	2-4924	12.59	2-4926	13.29
1/2	2-6226	11.80	2-4458	12.00	2-6234	12.92	2-4909	13.43	2-4481	13.99
5/8	2-4923	12.48	2-4460	12.83	2-6235	13.62	2-4925	14.10	2-4927	14.69
3/4	2-6227	13.20	2-4901	13.64	2-6236	14.31	2-4910	14.69	2-4917	15.39
1	2-6228	14.60	2-4902	15.17	2-6237	15.71	2-4911	16.25	2-4918	16.79
1 1/4	2-6229	15.99	2-4903	16.57	2-6238	17.10	2-4912	17.65	2-4919	18.19
1 1/2	2-6230	17.39	2-4904	17.97	2-6239	18.50	2-4461	19.10	2-4920	19.58
2	2-6231	18.78	2-4905	19.36	2-6240	19.90	2-4913	20.44	2-4921	20.98

MADE IN USA:
WE MAKE THESE IN
OUR SHOP FROM 300
SERIES STAINLESS

SPACERS - MADE IN USA

1 1/2" O.D. SPACERS

SIZE:	1/2 ID		9/16		5/8 ID		3/4 ID	
LENGTH	PART#	\$	PART#	\$	PART#	\$	PART#	\$
1/4	2-4477	12.58	2-4936	12.94	2-4951	13.28	2-4938	13.63
3/8	2-6290	13.89	2-6254	14.23	2-4952	14.66	2-4939	15.11
1/2	2-6247	15.20	2-6255	15.68	2-4953	16.00	2-4942	16.62
3/4	2-6248	17.23	2-6256	18.42	2-4954	18.89	2-4943	19.59
7/8	2-6249	19.39	2-6291	19.71	2-4931	20.43	2-4944	20.99
1	2-6250	20.96	2-6257	20.99	2-4933	21.83	2-4945	22.56
1 1/4	2-6251	23.10	2-6258	23.90	2-4934	24.71	2-4946	25.54
1 1/2	2-6252	25.70	2-6259	26.64	2-4935	27.57	2-4948	27.80
2	2-6253	28.32	2-6260	29.38	2-4937	30.43	2-4947	31.48

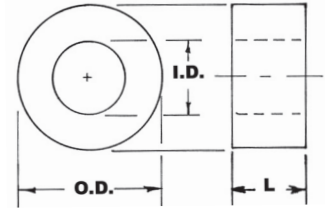

WE CUSTOM MAKE BUSHINGS & WASHERS UP TO 2" O.D - ANY LENGTH (THICKNESS) & INSIDE DIAMETER, DETERMINE THE ID, OD & THICKNESS AND GIVE US A CALL!

2" O.D. SPACERS

SIZE:	1/2 ID		9/16 ID		5/8 ID		3/4	
LENGTH	PART#	\$	PART#	\$	PART#	\$	PART#	
1/4	2-6293	13.32	2-4471	13.44	2-4970	13.97	2-4980	14.49
5/16	2-4451	14.37	2-4961	14.60	2-4468	15.22	2-6296	15.85
3/8	2-4949	15.42	2-4962	15.75	2-4971	16.59	2-4982	16.91
1/2	2-4950	17.52	2-4963	17.73	2-4972	18.33	2-4983	18.36
5/8	2-4955	19.62	2-4964	19.94	2-4974	20.57	2-4984	20.96
3/4	2-4956	21.72	2-4965	22.21	2-4975	22.81	2-4985	23.10
1	2-4957	25.92	2-4966	26.59	2-4976	27.29	2-4986	27.81
1 1/4	2-4958	30.12	2-4967	30.94	2-4977	31.87	2-4987	32.54
1 1/2	2-4959	34.32	2-4968	35.31	2-4978	36.35	2-4988	37.26
2	2-4960	38.52	2-4969	39.68	2-6294	40.83	2-4989	41.99

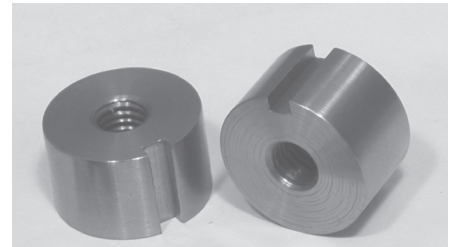

TAILGATE MOUNT BUSHINGS
FOR 1954-87 CHEVY STEPSIDE TRUCKS

2-4704 \$15.65 EACH

USED WITH 7/16-14 X 1 BOLTS

SPECIALTY WASHERS - MADE IN USA

CORE SUPPORT BODY MOUNT WASHER FOR 1960-72 CHEVY TRUCKS & 1960-64 CARS

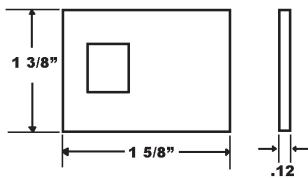

2-4400 \$ 4.35

BED MOUNT WASHERS FOR CHEVY TRUCKS

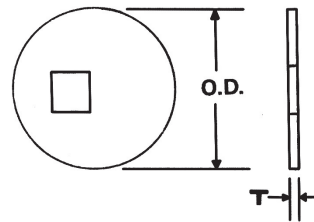

SIZE	NAME	O.D.	T	PART#	\$
3/8	PRE 1973	1.50	.12	2-4246	3.50
1/2	73 & UP	1.82	.12	2-4247	5.50

WASHER FOR C4 CORVETTE REAR SUSPENSION

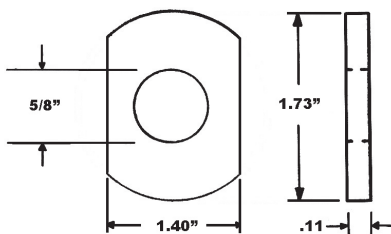

2-4475 \$ 4.30

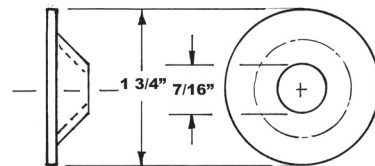

BED MOUNT WASHER FOR FORD TRUCKS
NOTE ID SHOWS 7/16 - BUT 1/2" FLAT SOCKETS WILL FIT - SEE PAGE 102

2-4408 \$ 3.89

SPECIALTY WASHERS

RUBBER BACKED WASHERS

GREAT FOR SEALING BOLTS ON
CENTER BOLT VALVE COVERS
OR FOR PROTECTING
DELICATE PAINT

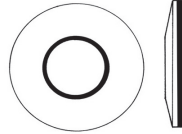

SIZE	O.D.	PART#	\$
#10	1/2	2-4489	.12
1/4	5/8	2-4465	.15
5/16	3/4	2-4466	.24
3/8	7/8	2-4467	.29
1/2	1	2-4469	.46

COUNTERSUNK WASHERS (DIMPLE WASHERS)

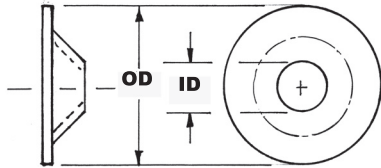

USED ON LATE 1920'S & EARLY 1930'S DOOR
HINGES - USUALLY WITH SLOTTED OVAL
JACKSON HEAD SCREWS - SEE PG 112/114

I.D.	O.D.	PART #	\$
#10	5/8	2-4790	.29
#10	3/4	2-4715	.39
#12	5/8	2-4791	.32
#12	3/4	2-4716	.39
1/4*	11/16	2-4794	.38
1/4**	11/16	2-4792	.38
1/4	1	2-4797	.42
5/16**	3/4	2-4795	.49
5/16	1	2-4793	.42
5/16	1 1/4	2-4798	.49

* FOR SCREWS WITH UNDERSIZED (#10) HEADS ONLY

** FOR SCREWS WITH UNDERSIZED (#12) HEADS ONLY

TRIM WASHERS

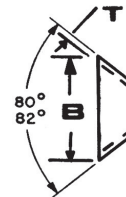
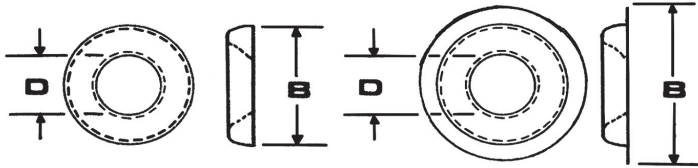

NOTE:
ORDER BY
HEAD SIZE, NOT
SCREW SIZE

BOLT SIZE D	FINISHING (CUP)			FLANGED (CUP)		
	B	PART#	\$	B	PART#	\$
#4	.375	2-4256	.03			
#6	.40	2-4250	.03	.50	2-4280	.06
#8	.515	2-4251	.04	.60	2-4281	.07
#10	.600	2-4252	.05	.70	2-4282	.08
#12	.697	2-4253	.08			
1/4	.785	2-4254	.11			
5/16	.885	2-4255	.15			

SCREW HEAD	COUNTERSUNK FLAT			
	B	T	PART#	\$
#4	1/4	.02	2-4269	.15
#6	5/16	.03	2-4270	.16
#8	3/8	.03	2-4271	.16
#10	7/16	.03	2-4272	.17
#12	1/2	.03	2-4273	.17
1/4	9/16	.04	2-4274	.19
5/16	23/32	.04	2-4491	.20

STAINLESS ALIGNMENT SHIMS * MADE IN AUSTRALIA*

AVAILABLE IN (3) THICKNESSES:

THICKNESS	PART#	\$
1/32	2-4497	2.00
1/16	2-4498	2.25
1/8	2-4499	2.75

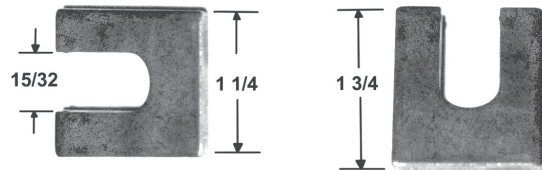

CURVED LOCK WASHERS - OFTEN USED WITH SHOULDER BOLTS (CONVERTIBLE TOPS, ETC)



SIZE	A	B	T	PART #	\$
#10	.22	.38	.02	1-2109	.06
1/4	.26	.48	.02	1-2110	.07
5/16	.33	.59	.02	1-2111	.12
3/8	.39	.62	.03	2-4360	.39
7/16	.46	.75	.03	2-4369	.44
1/2	.52	.87	.03	2-4361	.49

US LOCK WASHERS

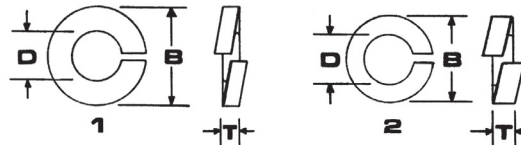

BOLT SIZE D	STANDARD SPLIT LOCK				HIGH COLLAR LOCK (FOR SOCKET HEAD BOLTS)			
	B1	T1	PART#	\$	B2	T2	PART#	\$
#4	.212	.025	2-4300	.04				
#6	.212	.031	2-4301	.04				
#8	.296	.040	2-4302	.04	.26	.05	2-4356	.03
#10	.337	.047	2-4303	.04	.29	.05	2-4314	.05
#12	.380	.056	2-4304	.05				
1/4	.493	.062	2-4305	.06	.36	.08	2-4316	.10
5/16	.591	.078	2-4306	.11	.45	.095	2-4317	.19
3/8	.688	.094	2-4307	.14	.56	.125	2-4318	.25
7/16	.784	.109	2-4308	.21				
1/2	.879	.125	2-4309	.27	.73	.175	2-4320	.50
9/16	.971	.141	2-4312	.39				
5/8	1.09	.156	2-4310	.60	.90	.21	2-4321	.75
3/4	1.25	.187	2-4313	.85				
7/8	1.43	.235	2-4315	1.35				

LOCK WASHER SHOP
ASSORTMENT: 3105
PIECES INTERNAL,
EXTERNAL, SPLIT &
C' SUNK EXTERNAL
3-3078 \$ 192.00

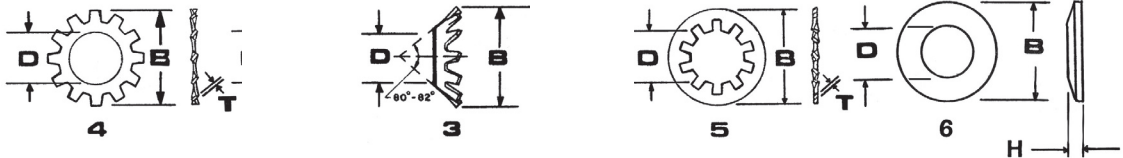

BOLT SIZE D	EXTERNAL TOOTH				COUNTERSUNK EXT. TOOTH (FOR FLAT HEAD BOLTS)			INTERNAL TOOTH				CONICAL				
	B5	T5	PART#	\$	B6	PART#	\$	B7	T7	PART#	\$	B8	H	T8	PART#	\$
#4	.253	.017	2-4331	.04				.270	.015	2-4343	.04					
#6	.320	.019	2-4332	.04	.301	2-4323	.13	.295	.017	2-4344	.04					
#8	.381	.021	2-4333	.04	.340	2-4324	.14	.340	.018	2-4345	.04					
#10	.410	.023	2-4334	.04	.369	2-4325	.15	.381	.020	2-4346	.04	.437	.048	.025	2-4363	.19
#12	.475	.026	2-4335	.07	.421	2-4326	.22	.410	.020	2-4347	.08					
1/4	.510	.026	2-4336	.05	.468	2-4327	.23	.478	.023	2-4348	.05	.500	.062	.030	2-4365	.21
5/16	.610	.028	2-4337	.06	.614	2-4328	.24	.610	.028	2-4349	.06	.625	.078	.040	2-4366	.24
3/8	.694	.032	2-4338	.09	.765	2-4329	.25	.692	.032	2-4350	.10	.750	.100	.050	2-4367	.29
7/16	.770	.032	2-4339	.16				.789	.032	2-4351	.16					
1/2	.900	.037	2-4340	.18				.900	.037	2-4352	.18					
5/8	1.07	.042	2-4341	.30				1.07	.042	2-4353	.30					
3/4	1.24	.051	2-4342	.40				1.23	.044	2-4354	.40					

VIBRATION PROOF LOCK WASHERS - HARDENED - 316 SS -

SIZE	O.D.	PART#	\$	SIZE	O.D.	PART#	\$
# 10	.35 (8.9MM)	2-4371	1.52	3/8 (10.4MM)	.62 (16MM)	2-4377	2.99
1/4	.45 (11.4MM)	2-4374	1.85	3/8 (10.4MM)	.83 (20.8MM)	2-4396	5.20
1/4	.53 (13.5MM)	2-4394	1.90	7/16 (11MM)	.73 (18.5MM)	2-4378	3.87
5/16 (8MM)	.53 (13.5MM)	2-4375	2.27	1/2 (12MM)	.77 (19.5MM)	2-4379	3.89
5/16 (8MM)*	.65 (16.5MM)	2-4395	2.68	9/16 (14MM)	.91 (23.1MM)	2-4380	5.51
				5/8 (16MM)	1.0 (25.4MM)	2-4381	5.51

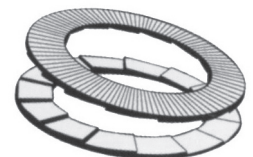

NOTE: (2) PAIRS ARE NEEDED WHEN THE BOLT IS USED WITH A NUT - (1) FOR UNDER THE BOLT & (1) FOR UNDER THE NUT - WILL NOT WORK WITH FLAT WASHERS!

FLAT HEAD SHEET METAL SCREWS

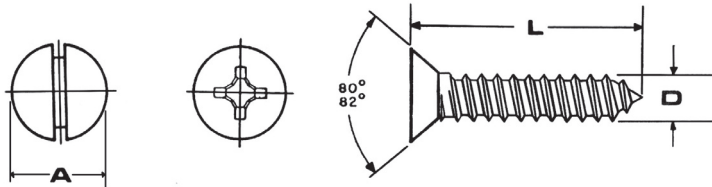

DIMENSION TABLE (INCHES)

D	DIAMETER	.112	.138	.164	.190	.216	.242
A	HEAD DIA.	.21	.25	.30	.35	.42	.45
	ISO#	4	6	8	10	12	14

**SLOTTED FLAT SHEET METAL
 SCREW ASSORTMENTS: SHOP**
 1210 PIECES # 3-3044 \$ 312.75
PERSONAL: 1000 PIECES 3-3177
 149.00

SLOTTED PART NUMBER AND PRICE GUIDE

ISO#	4		6		8		10		12		14	
LENGTH	PART#	\$	PART#	\$	PART#	\$	PART#	\$	PART#	\$	PART#	\$
1/4	2-1105	.07										
3/8	2-1100	.07	2-1106	.08	2-1142	.11	2-9944	.15				
1/2	2-1101	.08	2-1107	.09	2-1114	.12	2-1121	.16	2-1128	.25		
5/8	2-1102	.08	2-1108	.10	2-1115	.13	2-1122	.17	2-1129	.26		
3/4	2-1103	.09	2-1109	.11	2-1116	.14	2-1123	.18	2-1130	.27	2-1136	.38
1	2-1104	.10	2-1110	.12	2-1117	.15	2-1124	.20	2-1131	.30	2-1137	.43
1 1/4			2-1111	.13	2-1118	.16	2-1125	.22	2-1132	.32	2-1138	.49
1 1/2			2-1112	.14	2-1119	.18	2-1126	.24	2-1133	.34	2-1139	.69
1 3/4							2-1145	.26	2-1135	.36		
2			2-1113	.17	2-1120	.21	2-1127	.27	2-1134	.39	2-1140	.98
2 1/2							2-1146	.36	2-9946	.47		
3					2-1143	.29	2-1147	.45	2-9947	.58		

PHILLIPS PART NUMBER AND PRICE GUIDE

ISO#	4		5		6		8		10		12		14	
LENGTH	PART#	\$	PART#	\$	PART#	\$	PART#	\$	PART#	\$	PART#	\$	PART#	\$
1/4	2-1155	.03			2-9940	.04								
3/8	2-1150	.04			2-1156	.05	2-1163	.06	2-9953	.08				
1/2	2-1151	.05	2-1149	.09	2-1157	.05	2-1164	.07	2-1171	.09	2-9956	.11		
5/8	2-1152	.06			2-1158	.06	2-1165	.08	2-1172	.11	2-9957	.12	2-9960	.19
3/4	2-1153	.06			2-1159	.07	2-1166	.09	2-1173	.12	2-1180	.13	2-1186	.23
1	2-1154	.07			2-1160	.08	2-1167	.10	2-1174	.14	2-1181	.16	2-1187	.25
1 1/4					2-1161	.09	2-1168	.11	2-1175	.16	2-1185	.18	2-1199	.27
1 1/2					2-1162	.10	2-1169	.12	2-1176	.18	2-1183	.20	2-1189	.28
1 3/4							2-1179	.14	2-9954	.19	2-9958	.23	2-9961	.30
2							2-1144	.15	2-1177	.21	2-1184	.25	2-1190	.32
2 1/2							2-1170	.18	2-1145	.24	2-9959	.29	2-9962	.35
3							2-9952	.29	2-9955	.32	2-1182	.36	2-1188	.39
4													2-1198	.85

PHILLIPS FLAT SHEET METAL SCREW SHOP ASSORTMENT: 1210 PIECES 3-3025 178.00
PERSONAL ASSORTMENT: 1000 PIECES 3-3176 113.00

SQUARE DRIVE DECK SCREWS

SIZE	LENGTH	PART#	\$
#8	1 5/8	2-1194	.18
#8	2	2-1191	.19
#10	2 1/2	2-1192	.27
#10	3	2-1193	.32
#10	4	2-1195	.36

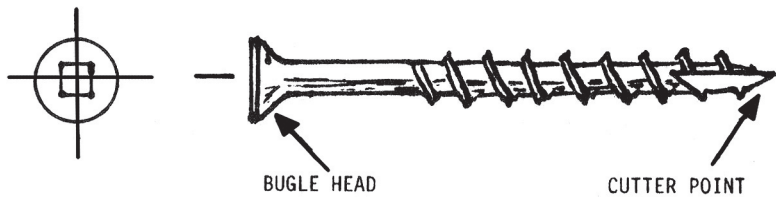

TRIM HEAD SCREWS:

#7 X 1 5/8 # 2-1197 \$.18 #7 X 2 1/4 # 2-1196 \$.19

HEX HEAD SHEET METAL SCREWS

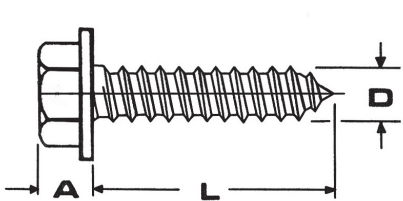
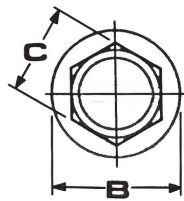
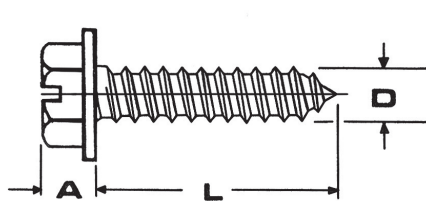
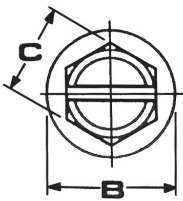

DIMENSION TABLE (INCHES)

D	DIAMETER	.138	.164	.190	.216	.242	.312
A	HEAD HT.	.079	.141	.151	.194	.240	.280
B	HEAD DIA.	.32	.34	.40	.42	.50	.65
C	WRENCH	1/4	1/4	5/16	5/16	3/8	1/2
	SIZE	6	8	10	12	14	5/16



**** NEW SIZES****
UNSLOTTED WASHER HEAD
 # 8 X 1/2 # 2-1049 \$.15
 # 8 X 3/4 2-1059 .17
 # 8 X 1 2-1075 .19

SLOTTED & UNSLOTTED PART NUMBER AND PRICE GUIDE

SIZE	6		8		10		10		12		14		14		5/16	
LENGTH	PART#	\$	PART#	\$	PART#	\$	UNSLOTTED WASHER HEAD		PART#	\$	PART#	\$	UNSLOTTED WASHER HEAD		PART#	\$
1/4	2-1000	.08														
3/8	2-1001	.09	2-1008	.09	2-1018	.10	PART#	\$					PART#	\$	PART#	\$
1/2	2-1002	.10	2-1009	.11	2-1019	.12	2-1026	.29	2-1029	.19	2-1039	.24	2-1084	.74		
5/8	2-1003	.12	2-1010	.12	2-1020	.13	2-1077	.32	2-1030	.20	2-1040	.26	2-1080	.79		
3/4	2-1004	.14	2-1011	.12	2-1021	.14	2-1078	.35	2-1031	.21	2-1041	.27	2-1081	.81	2-1086	1.26
7/8			2-1012	.14	2-1022	.16			2-1032	.22	2-1042	.29				
1			2-1013	.15	2-1023	.17	2-1079	.39	2-1033	.22	2-1043	.32	2-1082	.89	2-1087	1.29
1 1/4			2-1014	.17	2-1024	.22			2-1034	.25	2-1044	.35			2-1088	1.49
1 1/2			2-1015	.19	2-1025	.25			2-1035	.27	2-1045	.39				
1 3/4									2-1036	.29	2-1046	.41				
2									2-1037	.30	2-1047	.45				
3											2-1048	.59				

SLOTTED HEX SHEET METAL SCREW SHOP ASSORTMENT: 1000 PIECES # 3-3036 \$ 250.55

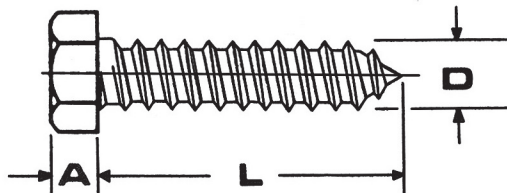
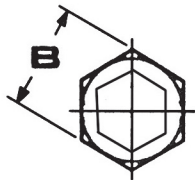

PLAIN INDENTED HEX DIMENSION TABLE (INCHES)

D	DIAMETER	.138	.164	.190	.216	.242	.312
A	HEAD HT.		.103	.112	.147	.156	.220
B	WRENCH	1/4	1/4	5/16	5/16	3/8	1/2
	SIZE	6	8	10	12	14	5/16

PLAIN INDENTED HEX PART NUMBER AND PRICE GUIDE

SIZE	6		8		10		12		14 (3/8 HEAD)		14 (7/16 HEAD)		5/16	
LENGTH	PART#	\$	PART#	\$	PART#	\$	PART#	\$	PART#	\$	PART#	\$	PART#	\$
3/8	2-1066	.15	2-1083	.16										
1/2			2-1050	.17	2-1053	.19	2-1056	.25						
5/8	2-1073	.16	2-1063	.18	2-1064	.22			2-1062	.39				
3/4			2-1051	.19	2-1054	.25	2-1057	.29	2-1060	.46				
1			2-1052	.22	2-1055	.29	2-1058	.33	2-1061	.49	2-1072	.65	2-1092	.99
1 1/4									2-1068	.54				
1 1/2									2-1070	.80				
2									2-1071	.99				

OVAL HEAD SHEET METAL SCREWS

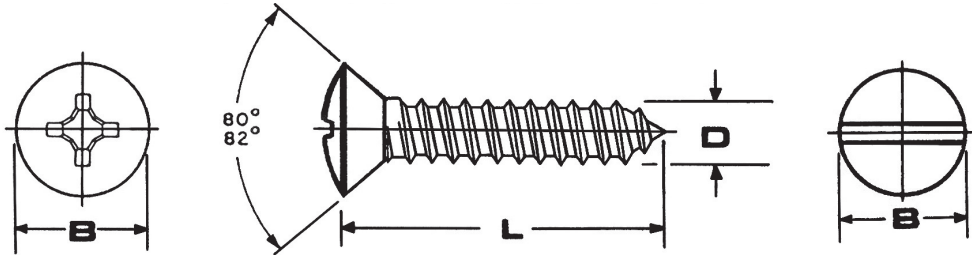

DIMENSION TABLE (INCHES)

D	DIAMETER	.112	.138	.164	.190	.216	.242
B	HEAD DIA.	.21	.26	.31	.36	.41	.45
	ISO#	4	6	8	10	12	14

PHILLIPS PART NUMBER & PRICES SLOTTED PART NUMBER & PRICES

SIZE	4		6		8		10		12		14	
LENGTH	PART#	\$	PART#	\$	PART#	\$	PART#	\$	PART#	\$	PART#	\$
1/4	2-6450	.06	2-6452	.08								
3/8	2-1449	.07	2-1457	.09	2-1496	.11	2-6453	.17				
1/2	2-1451	.08	2-1458	.09	2-1497	.13	2-1472	.18	2-6458	.21	2-6464	.26
5/8	2-1452	.09	2-1459	.10	2-1498	.14	2-1475	.19	2-6459	.22		
3/4	2-1453	.09	2-1456	.11	2-1471	.15	2-1476	.20	2-6460	.24	2-1488	.29
1	2-1462	.09	2-1465	.12	2-1470	.16	2-1473	.21	2-1487	.26	2-1489	.31
1 1/4			2-1454	.13	2-1469	.18	2-1478	.22	2-1482	.31	2-1490	.34
1 1/2			2-1463	.14	2-1499	.20	2-1479	.24	2-1494	.31	2-1491	.38
1 3/4					2-6454	.21	2-6456	.25	2-6461	.32	2-6465	.42
2					2-1474	.22	2-1480	.26	2-1493	.33	2-1492	.44
2 1/2					2-6455	.29	2-6457	.34	2-6462	.44	2-6466	.49
3									2-6463	.49		

SLOTTED OVAL SHEET METAL SHOP ASSORTMENT:
1210 PIECES
3-3039 \$325.75
PERSONAL ASSORTMENT:
1000 PIECES
3-3163 \$185.00



SIZE	4		6		8		10		12		14	
LENGTH	PART#	\$	PART#	\$	PART#	\$	PART#	\$	PART#	\$	PART#	\$
1/4	2-6400	.04	2-6402	.04								
3/8	2-1400	.04	2-1407	.05	2-1415	.06	2-6404	.08				
1/2	2-1401	.04	2-1408	.05	2-1416	.07	2-1424	.09	2-1437	.12	2-6409	.17
5/8	2-1402	.06	2-1409	.06	2-1417	.08	2-1425	.11	2-6406	.14		
3/4	2-1403	.06	2-1410	.07	2-1418	.09	2-1426	.13	2-1432	.16	2-1438	.19
7/8					2-1443	.10						
1	2-1404	.06	2-1411	.08	2-1419	.11	2-1427	.15	2-1433	.19	2-1439	.22
1 1/4			2-1412	.09	2-1420	.12	2-1428	.17	2-1434	.21	2-1440	.25
1 1/2			2-1413	.10	2-1421	.14	2-1429	.19	2-1435	.22	2-1441	.29
1 3/4					2-6403	.16	2-6405	.20	2-6407	.25	2-6410	.32
2					2-1422	.17	2-1430	.22	2-1436	.29	2-1442	.34
2 1/2					2-1405	.20	2-1431	.25	2-1445	.33		
3					2-1447	.24	2-1423	.30	2-6408	.39	2-1446	.45

PHILLIPS OVAL SHEET METAL SHOP ASSORTMENT:
1210 PIECES
#3-3007 \$220.50
PERSONAL ASSORTMENT:
1000 PIECES
#3-3159 \$112.75



PHILLIPS OVAL JACKSONS

SIZE:	8		10	
LENGTH	PART#	\$	PART#	\$
1/2	2-1481	.24		
5/8	2-1464	.27	2-1484	.44
3/4	2-1460	.29	2-1485	.49
1	2-1466	.34	2-1461	.54
1 1/4	2-1467	.39	2-1486	.59
1 1/2	2-1468	.44	2-1444	.64
1 3/4	2-1406	.49	2-1448	.69
2	2-1414	.54	2-1450	.74
2 1/2			2-1455	.89
3			2-1495	1.09

JACKSON (UNDERSIZED) HEAD TRIM SCREWS

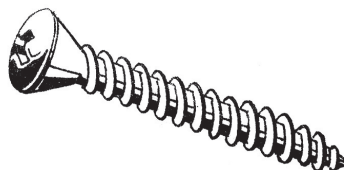

JACKSON HEAD		
D	.164	.190
B	.26	.31
ISO#	8	10

**NEED SLOTTED TRIM SCREWS?
WE CAN TURN THE HEADS DOWN
ON ANY OF OUR SLOTTED SCREWS:**

**ADD .80 TO THE COST OF A #8 SCREW
1.10 TO A #10, 1.20 TO A #12, 1.30 TO
THE COST OF A #14**

**PHILLIPS OVAL SHEET METAL SCREWS WITH JACKSON HEAD SCREWS
SHOP ASSORTMENT: 1540 PIECES # 3-3040 \$325.50
PERSONAL ASSORTMENT: 1000 PIECES 3-3161 209.10**

PAN HEAD SHEET METAL SCREWS

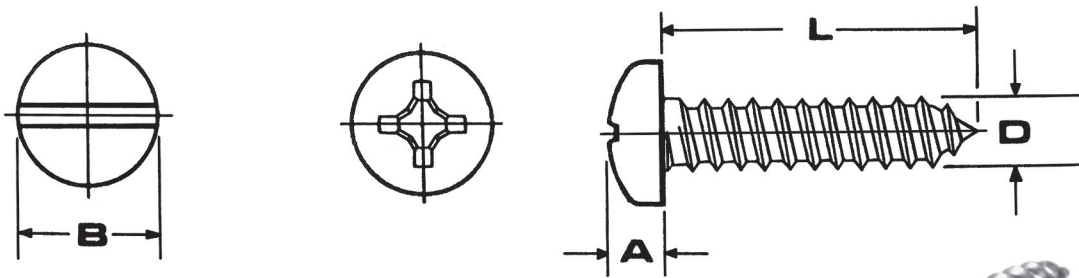

DIMENSION TABLE (INCHES)

D	DIAMETER	.112	.138	.164	.190	.216	.242
A	HEAD HT.	.068	.082	.096	.110	.125	.144
B	HEAD DIA.	.22	.26	.32	.37	.42	.47
	ISO#	4	6	8	10	12	14

**ADDITIONAL SIZE:
#2 X 3/8" SLOTTED
#2-1200 \$.06**



SLOTTED PART NUMBER AND PRICE GUIDE

SIZE:	4		6		8		10		12		14	
LENGTH	PART#	\$	PART#	\$	PART#	\$	PART#	\$	PART#	\$	PART#	\$
1/4	2-1214	.06	2-1222	.08	2-1225	.12						
3/8	2-1201	.07	2-1207	.09	2-1216	.13	2-1228	.18				
1/2	2-1202	.07	2-1208	.09	2-1217	.13	2-1229	.19	2-1236	.24	2-1243	.32
5/8	2-1215	.08	2-1209	.10	2-1218	.14	2-1230	.20	2-1237	.26	2-1244	.33
3/4	2-1204	.09	2-1210	.11	2-1219	.15	2-1231	.21	2-1238	.28	2-1245	.34
1	2-1205	.10	2-1211	.12	2-1220	.16	2-1232	.23	2-1235	.32	2-1246	.37
1 1/4			2-1223	.14	2-1226	.17	2-1233	.24	2-1240	.35	2-1247	.39
1 1/2			2-1224	.16	2-1221	.17	2-1234	.25	2-1241	.39	2-1248	.46
2							2-1227	.29	2-1242	.48		

PHILLIPS PART NUMBER AND PRICE GUIDE

SIZE:	4		5		6		8		10		12		14	
LENGTH	PART#	\$	PART#	\$	PART#	\$	PART#	\$	PART#	\$	PART#	\$	PART#	\$
1/4	2-1250	.04			2-1258	.06	2-1268	.06	2-1329	.08				
3/8	2-1251	.04			2-1259	.07	2-1269	.07	2-1280	.09				
1/2	2-1252	.05	2-1212	.26	2-1260	.08	2-1270	.08	2-1281	.10	2-1291	.15	2-1301	.19
5/8	2-1253	.05			2-1261	.09	2-1271	.09	2-1282	.11	2-1292	.18	2-1302	.23
3/4	2-1254	.05			2-1262	.10	2-1272	.10	2-1283	.12	2-1293	.19	2-1303	.25
1	2-1255	.06			2-1263	.11	2-1273	.11	2-1284	.13	2-1294	.21	2-1304	.29
1 1/4	2-1256	.13			2-1264	.12	2-1274	.12	2-1285	.20	2-1295	.22	2-1305	.39
1 1/2	2-1257	.17			2-1265	.13	2-1275	.13	2-1286	.22	2-1296	.24	2-1306	.42
1 3/4					2-1266	.18	2-1276	.16	2-1287	.24	2-1297	.26	2-1311	.44
2					2-1267	.19	2-1277	.19	2-1288	.26	2-1298	.29	2-1308	.49
2 1/2							2-1278	.26	2-1289	.28	2-1299	.35	2-1309	.54
3							2-1279	.29	2-1290	.30	2-1300	.43	2-1310	.59

#12 x 1 JACKSON HEAD (.36/.37 HEAD DIAMETER): 2-1326 \$2.25 EACH

SLOTTED PAN SHEET METAL SCREW SHOP ASSORTMENT: 1210 PIECES # 3-3043 \$ 314.50
PERSONAL ASSORTMENT: 1000 PIECES 3-3179 175.00
PHILLIPS PAN SHEET METAL SCREW SHOP ASSORTMENT: 1210 PIECES 3-3006 228.50
PERSONAL ASSORTMENT: 1000 PIECES 3-3178 108.00



TOLL FREE ORDER LINE : 1-800-767-4781

ROUND HEAD SHEET METAL SCREWS

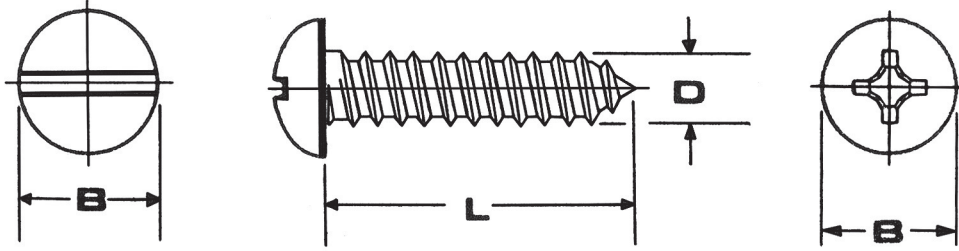

DIMENSION TABLE (INCHES)

D	DIAMETER	.112	.138	.164	.190	.242
B	HEAD DIA.	.20	.25	.30	.35	.45
	ISO#	4	6	8	10	14

SLOTTED PART NUMBER AND PRICE GUIDE

SIZE:	4		6		8		10		12		14	
LENGTH	PART#	\$	PART#	\$	PART#	\$	PART#	\$	PART#	\$	PART#	\$
1/4	2-1622	.09	2-1600	.14								
3/8			2-1605	.15	2-1626	.17	2-1630	.22				
1/2	2-1621	.13	2-1601	.15	2-1608	.18	2-1614	.23	2-1641	.29	2-1647	.38
5/8	2-1623	.14	2-1606	.17	2-1627	.19	2-1631	.24				
3/4			2-1602	.17	2-1609	.20	2-1615	.25	2-1642	.31	2-1640	.42
1			2-1603	.18	2-1610	.25	2-1616	.26	2-1643	.33	2-1648	.44
1 1/4							2-1617	.28			2-1637	.47
1 1/2			2-1604	.21	2-1612	.30	2-1618	.30	2-1645	.37	2-1649	.49
2							2-1619	.33	2-1646	.39		

PHILLIPS PART NUMBER AND PRICE GUIDE

SIZE:	4		6		8		10		12		14	
LENGTH	PART#	\$	PART#	\$	PART#	\$	PART#	\$	PART#	\$	PART#	\$
1/4	2-1651	.04	2-1674	.05	2-1675	.08						
3/8	2-1652	.04	2-1670	.05	2-1660	.09	2-1687	.12				
1/2	2-1653	.04	2-1656	.05	2-1661	.09	2-1666	.13				
5/8			2-1695	.06							2-1692	.35
3/4	2-1654	.05	2-1657	.07	2-1662	.11	2-1667	.14	2-1690	.18	2-1693	.39
1			2-1658	.08	2-1663	.13	2-1668	.16	2-1691	.19	2-1679	.54
1 1/4					2-1697	.16	2-1698	.19				
1 1/2			2-1696	.12	2-1664	.18	2-1669	.21			2-1680	.89
1 3/4					2-1682	.19						
2					2-1683	.20	2-1672	.26				

SLOTTED ROUND PERSONAL ASSORTMENT: 1000 PIECES 3-3181 \$ 155.00

PHILLIPS ROUND PERSONAL ASSORTMENT: 1000 PIECES 3-3180 108.00

ROUND WASHER (.36 O.D. FLANGE) HEAD - COMMONLY USED ON GLOVE BOX LINERS AND WHEEL WELL TRIM

- #8 X 3/8 # 2-1676 \$.14
- #8 X 1/2 2-1677 .18*
- #8 X 5/8 2-1684 .22
- #8 X 3/4 2-1685 .25
- #8 X 1 2-1686 .29

*WHEEL WELL MOLDING TRIM SCREW KIT
6-1796 SET OF 30 \$ 8.00

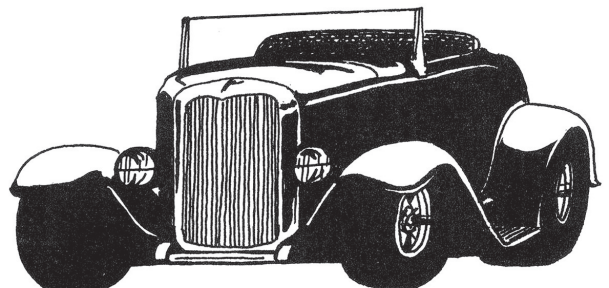

TRUSS HEAD SHEET METAL SCREWS

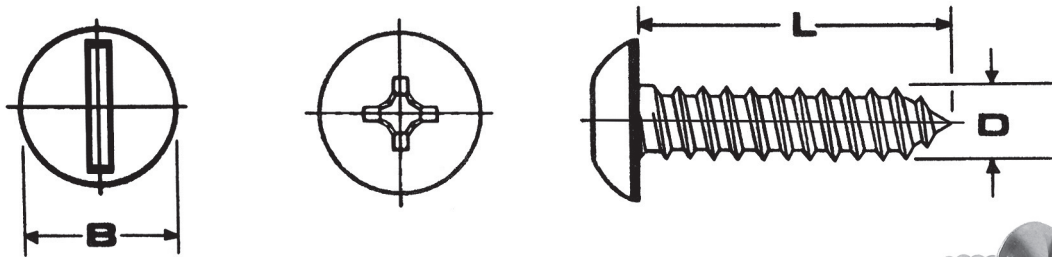

DIMENSION TABLE (INCHES)

D	DIAMETER	.112	.138	.164	.190	.216	.242
B	HEAD DIA.	.25	.31	.38	.43	.50	.55
	ISO#	4	6	8	10	12	14

SLOTTED PART NUMBER AND PRICE GUIDE

SIZE:	4		6		8		10		12		14	
LENGTH	PART#	\$	PART#	\$	PART#	\$	PART#	\$	PART#	\$	PART#	\$
1/4	2-1585	.06										
3/8	2-1586	.06	2-1550	.08	2-1558	.09	2-1566	.17				
1/2	2-1587	.07	2-1551	.08	2-1559	.09	2-1567	.18	2-1578	.24	2-1592	.32
5/8			2-1552	.09	2-1560	.10	2-1568	.19	2-1579	.25	2-1593	.34
3/4	2-1589	.08	2-1553	.10	2-1561	.11	2-1569	.20			2-1580	.36
1			2-1554	.11	2-1562	.12	2-1570	.21			2-1594	.38
1 1/4					2-1563	.15	2-1573	.23			2-1595	.43
1 1/2			2-1557	.16	2-1564	.19	2-1571	.26			2-1596	.48
2							2-1572	.29				

PHILLIPS PART NUMBER AND PRICE GUIDE

SIZE:	4		6		8		10		12		14	
LENGTH	PART#	\$	PART#	\$	PART#	\$	PART#	\$	PART#	\$	PART#	\$
1/4	2-1546	.04	2-1544	.05								
3/8	2-1501	.04	2-1507	.05	2-1515	.06	2-1523	.07				
1/2	2-1502	.05	2-1508	.05	2-1516	.08	2-1524	.09	2-1537	.17	2-1575	.19
5/8			2-1509	.06	2-1517	.13	2-1525	.14			2-1576	.24
3/4	2-1548	.05	2-1510	.07	2-1518	.14	2-1526	.15	2-1532	.19	2-1538	.28
1	2-1504	.05	2-1511	.08	2-1519	.15	2-1527	.16	2-1533	.21	2-1539	.33
1 1/4			2-1512	.08	2-1520	.16	2-1528	.17	2-1534	.23	2-1540	.39
1 1/2			2-1574	.09	2-1521	.18	2-1529	.19	2-1535	.25	2-1541	.45
1 3/4					2-1555	.20	2-1556	.21				
2					2-1522	.22	2-1530	.23	2-1536	.29	2-1542	.49

SLOTTED TRUSS SHEET METAL SCREW SHOP ASSORTMENT: 1210 PIECES # 3-3058 \$ 317.50
PERSONAL ASSORTMENT: 1000 PIECES 3-3162 164.00
PHILLIPS TRUSS SHEET METAL SCREW SHOP ASSORTMENT: 1210 PIECES 3-3026 176.00
PERSONAL ASSORTMENT: 1000 PIECES 3-3160 108.00

TRAILER SCREWS (SQUARE DRIVE):

- #8 X 3/4 # 2-1514 \$.14
- #8 X 1 2-1513 .16
- #8 X 1 1/2 2-1531 .19
- #10 X 3/4 2-1500 .19
- #10 X 1 2-1503 .21
- #10 x 1 1/2 2-1545 .37

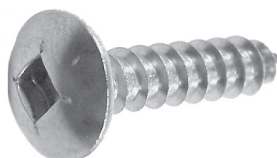

SMALL HEAD TRUSS TRIM SCREWS:

- #8 X 3/8 PHILLIPS JACKSON (#5 HEAD) # 2-1597 \$.13
- #8 X 1/2 PHILLIPS JACKSON (#5 HEAD) 2-1598 .15



PIPE FITTINGS - IN STOCK ITEMS

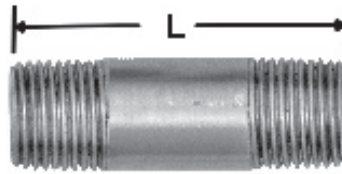

PIPE NIPPLES - THREADED ON EACH END

SIZE:	1/8		1/4		3/8		1/2	
LENGTH	PART#	\$	PART#	\$	PART#	\$	PART#	\$
CLOSE*	7-0219	3.49	7-0229	3.88	7-0230	4.59	7-0231	5.38
1 1/2	7-0224	4.48	7-0232	4.76	7-0240	4.98	7-0262	6.24
2	7-0225	4.79	7-0234	5.23	7-0241	5.39	7-0263	6.24
3	7-0226	5.66	7-0236	6.77	7-0243	7.22	7-0265	8.38
4	7-0228	6.98	7-0238	7.69	7-0245	8.89	7-0267	10.49
5					7-0247	10.78	7-0269	12.38

* CLOSE NIPPLES ARE FULLY THREADED NIPPLES

PLAIN PIPE - NO THREADS

PART #	PIPE SIZE	\$ PER FOOT	PIPE ID	PIPE OD
7-0221	1/4	7.99	.37	.54
7-0222	3/8	9.98	.48	.67
7-0223	1/2	14.69	.59	.84

*AVAILABLE IN LONGER LENGTHS - MADE TO ORDER

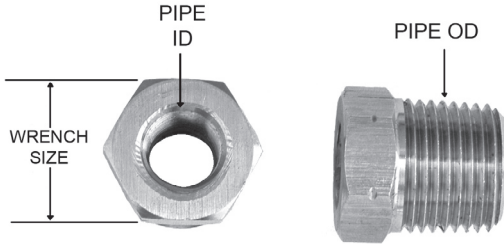
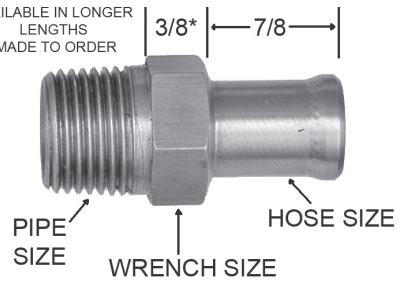

HOSE BARBS - 2" OVERALL LENGTH					
PART #	\$	WRENCH SIZE	HOSE SIZE	PIPE SIZE	LENGTH L
7-0314	23.49	3/4	5/8	3/8	7/8
7-0318	25.00	7/8	5/8	1/2	7/8
7-0319	25.00	7/8	3/4	1/2	7/8

HEX REDUCERS - IN STOCK ITEMS				
PART #	\$	WRENCH SIZE	PIPE ID	PIPE OD
7-0330	7.48	9/16	1/8	1/4
7-0331	8.69	3/4	1/8	3/8
7-0332	8.69	3/4	1/4	3/8
7-0333	11.32	7/8	1/8	1/2
7-0334	11.32	7/8	1/4	1/2
7-0335	11.32	7/8	3/8	1/2
7-0336	15.96	1 1/16	1/4	3/4
7-0337	15.96	1 1/16	3/8	3/4
7-0338	15.96	1 1/16	1/2	3/4

OEM STYLE HOSE BARBS FOR PONTIACS - MADE TO ORDER

PART #	\$	WRENCH SIZE	HEX HEIGHT	HOSE SIZE	PIPE SIZE	OVERALL LENGTH
7-0345	28.98	7/8	.19	5/8	1/2	1.86
7-0347	29.99	7/8	.19	5/8	1/2	2.25
7-0375	30.50	7/8	.22	3/4	1/2	2.33



- PLACE YOUR FITTING ON THE CIRCLES TO CHECK FOR SIZE! -

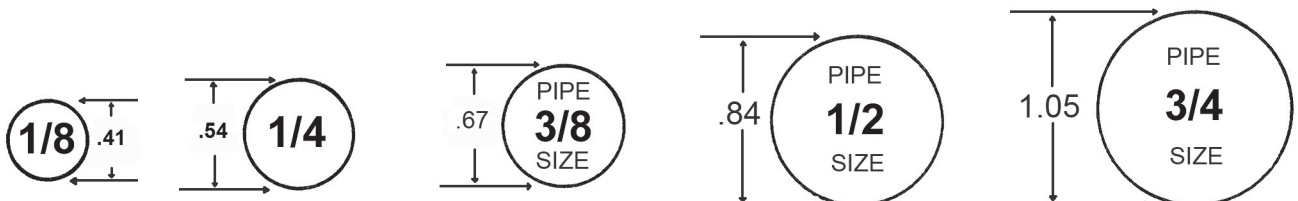

TOLL FREE ORDER LINE : 1-800-767-4781

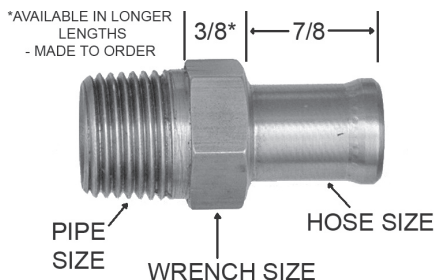

SPECIALTY PIPE FITTINGS - MADE TO ORDER - NOT STOCK ITEMS

**MADE IN USA:
WE MAKE ALL OF
THESE IN OUR SHOP
FROM 300 SERIES
STAINLESS**



SLOTTED END HOSE BARBS

1/4 NPT X 1/2 HOSE X 1 3/8"	# 7-0349	\$ 18.73
3/8 NPT X 5/8 HOSE X 1 3/8"	7-0350	25.68
3/8 NPT X 3/4 HOSE X 1 3/8"	7-0354	20.40
3/8 NPT X 5/8 HOSE X 3"	7-0351	20.94
1/2 NPT X 5/8 HOSE X 1 5/8"	7-0355	26.73
1/2 NPT X 3/4 HOSE X 1 5/8"	7-0352	26.77
1/2 NPT X 3/4 HOSE X 3"	7-0353	21.90

COMPACT HOSE BARBS					
PART #	\$	WRENCH SIZE	HOSE SIZE	PIPE SIZE	LENGTH L
7-0250	22.51	3/8	1/4	1/16	1/2
7-0251	24.10	7/16	1/8	1/8	1/2
7-0252	24.15	7/16	3/16	1/8	1/2
7-0253	23.98	7/16	1/4	1/8	5/8
7-0254	23.93	7/16	5/16	1/8	5/8
7-0255	23.88	7/16	3/8	1/8	5/8
7-0256	24.61	9/16	1/8	1/4	5/8
7-0257	24.55	9/16	3/16	1/4	5/8
7-0258	24.50	9/16	1/4	1/4	5/8
7-0259	24.44	9/16	5/16	1/4	5/8
7-0260	24.72	9/16	3/8	1/4	3/4
7-0261	24.66	9/16	1/2	1/4	3/4

HOSE BARBS					
PART #	\$	WRENCH SIZE	HOSE SIZE	PIPE SIZE	LENGTH L
7-0310	26.19	3/4	3/16	3/8	3/4
7-0311	26.10	3/4	1/4	3/8	7/8
7-0372	26.00	3/4	5/16	3/8	7/8
7-0312	25.87	3/4	3/8	3/8	7/8
7-0313	25.77	3/4	1/2	3/8	7/8
7-0314	25.66	3/4	5/8	3/8	7/8
7-0315	26.92	7/8	3/4	3/8	7/8
7-0322	27.24	7/8	1/4	1/2	7/8
7-0373	27.13	7/8	5/16	1/2	7/8
7-0316	27.00	7/8	3/8	1/2	7/8
7-0317	26.92	7/8	1/2	1/2	7/8
7-0318	27.25	7/8	5/8	1/2	7/8
7-0319	27.25	7/8	3/4	1/2	7/8

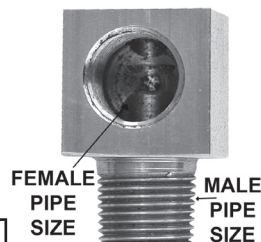
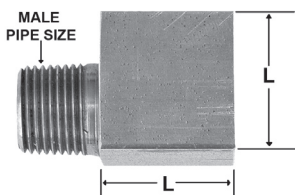

RIGHT ANGLE FITTINGS 90			
PART#	PIPE SIZE MALE/FEMALE	L	\$
7-0360	1/8 / 1/8	5/8	25.12
7-0364	1/4 / 1/8	5/8	25.72
7-0361	1/4 / 1/4	3/4	26.18
7-0362	3/8 / 1/4	3/4	25.87
7-0320	3/8 / 3/8	1	27.21
7-0321	1/2 / 3/8	1	26.82
7-0329	1/2 / 3/8	1 1/2	29.00

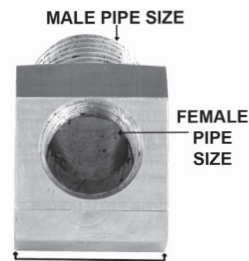
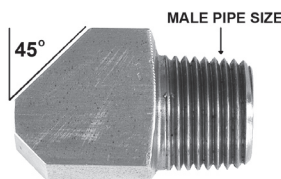

45 DEGREE FITTINGS			
PART#	PIPE SIZE MALE/FEMALE	L	\$
7-0325	1/8 / 1/8	5/8	26.10
7-0368	1/4 / 1/8	5/8	25.65
7-0327	1/4 / 1/4	3/4	27.76
7-0374	3/8 / 1/8	3/4	28.28
7-0369	3/8 / 1/4	3/4	27.84
7-0323	3/8 / 3/8	1	29.34
7-0324	1/2 / 3/8	1	28.78

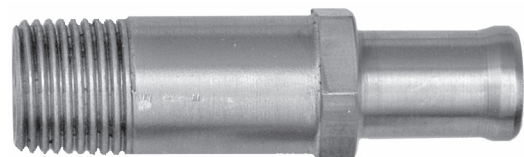

EXTENDED HOSE BARBS - 3" OVERALL LENGTH				
PART#	\$	WRENCH SIZE	HOSE SIZE	PIPE SIZE
7-0341	30.30	3/4	5/8	3/8
7-0342	32.33	7/8	3/4	3/8
7-0339	32.43	7/8	5/8	1/2
7-0340	32.75	7/8	3/4	1/2

AVAILABLE IN LONGER LENGTHS TO ORDER

**WE CUSTOM MAKE PARTS FROM BAR STOCK IF YOU
NEED A SPECIALTY FITTING - WE CAN MAKE IT!**

PIPE PLUGS

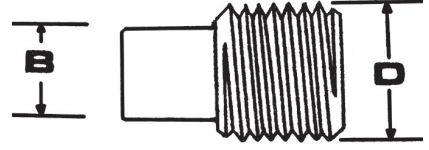
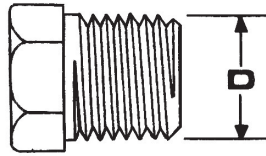
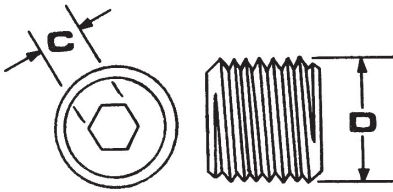

PIPE SIZE	HEX SOCKET			
	D	C	PART#	\$
1/8	.405	3/16	7-0100	.99
1/4	.540	1/4	7-0101	1.25
3/8	.675	5/16	7-0102	1.75
1/2	.84	3/8	7-0103	2.50
3/4	1.05	9/16	7-0104	4.25
1	1.30	5/8	7-0105	9.25

PIPE SIZE	HEX HEAD			
	D	A	PART#	\$
1/8	.405	7/16	7-0106	2.25
1/4	.540	9/16	7-0107	3.50
3/8	.675	11/16	7-0108	5.25
1/2	.84	7/8	7-0109	9.25
3/4	1.05	1 1/8	7-0110	14.25

PIPE SIZE	SQUARE HEAD			
	D	B	PART#	\$
1/8	.405	9/32	7-0112	2.50
1/4	.540	3/8	7-0113	3.50
3/8	.675	7/16	7-0114	5.25
1/2	.84	9/16	7-0115	9.25
3/4	1.05	5/8	7-0116	15.25

- PLACE YOUR PLUG ON THE CIRCLES TO CHECK FOR SIZE! -

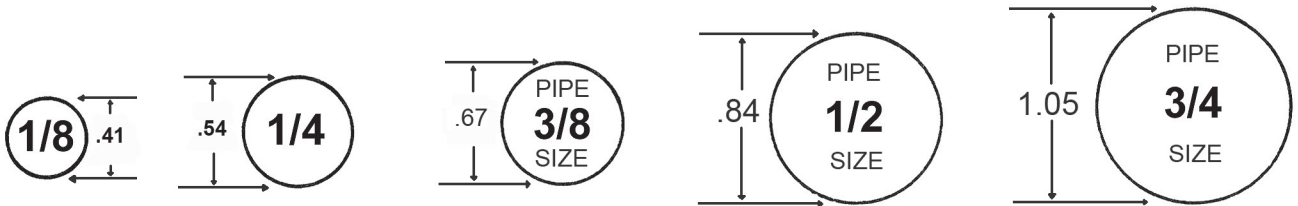

OIL PAN & REAR END PLUGS CUSTOM MADE IN OUR SHOP!



**OEM & CUSTOM STYLES:
THE BUTTON HEADS
LOOK GREAT &
REDUCE THE CHANCE
OF SNAGGING ON
LOWERED VEHICLES
AND 4 X 4'S**

OIL PAN PLUGS: SUPER LOW PROFILE!

1/2-20 BUTTON HEAD (3/4" OD FLANGE) # 7-0402 \$ 20.00

PLUGS FOR DIFFERENTIALS:

5/8-18: (1" OD FLANGE) (FOR SOME 9" FORD DIFFERENTIALS)
 BUTTON HEAD 7-0403 23.75
 SQUARE FLANGE HEAD 7-0404 32.50

3/4-16: (1 1/8" OD FLANGE) (FOR SOME 9" FORD DIFFERENTIALS)
 BUTTON HEAD 7-0405 26.75
 SQUARE FLANGE HEAD 7-0406 38.50

7/8-18 (1" OD FLANGE)
 BUTTON HEAD 7-0414 23.75

1-20 (1 3/8" OD FLANGE) FOR 1950'S GM CARS & TRUCKS
 BUTTON HEAD 7-0401 34.25
 SQUARE FLANGE HEAD - ORIGINAL STYLE 7-0400 44.75

16-1.5 MM PLUG
 BUTTON HEAD (1" OD FLANGE) 7-0413 23.75

22-1.5 MM PLUGS FOR GM 4X4 TRANSFER CASES
 BUTTON HEAD (1 1/4" OD FLANGE) 7-0407 30.50

1/2" STRAIGHT PIPE THREAD (1 1/4" OD FLANGE) (FOR '56-'66 BOP)
 BUTTON HEAD 7-0409 34.25
 SQUARE FLANGE HEAD - ORIGINAL STYLE 7-0410 43.00

STAINLESS GREASE FITTINGS

SIZE:	A	B	C	X	PART#	\$
1/4-28 STRAIGHT	.54	.20	---	5/16	7-0054	2.50
1/4-28 45 DEGREE	.88	.20	.37	3/8	7-0055	6.50
1/4-28 90 DEGREE	.69	.20	.44	3/8	7-0056	6.50
1/8 NPT STRAIGHT	.62	.25	---	7/16	7-0050	3.99
1/8 NPT 45 DEGREE	.99	.27	.40	7/16	7-0051	9.50
1/8NPT 90 DEGREE	.82	.27	.47	7/16	7-0052	9.50

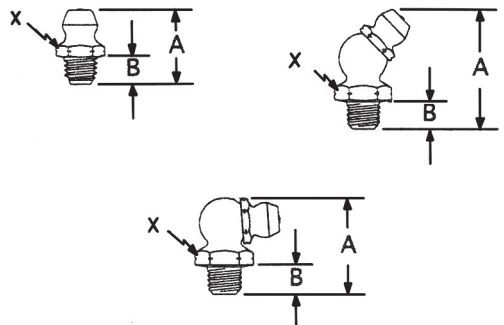

HOSE CLAMPS

**100% 300 SERIES STAINLESS
MARINE GRADE**



EXHAUST CLAMPS

**HEAVY DUTY - 3/8 U-BOLTS
MADE IN USA**



****AVAILABLE ELECTRO-POLISHED FOR ADDITIONAL
CORROSION PROTECTION AND A BRILLANT APPEARANCE!**
- JUST ADD A "P" TO THE END OF THE PART#!-**

SIZE:	PART#	\$
1 1/2	7-1002	11.95
1 3/4	7-1004	12.35
1 7/8	7-1005	12.80
2	7-1000	12.95
2 1/4	7-1001	13.95
2 1/2	7-1003	14.95
3	7-1006	16.95
3 1/2	7-1007	21.95
4	7-1008	24.95

PART#	DESCRIPTION	PLAIN	POLISHED
	MIMI CLAMPS (5/16" WIDE)		
7-0001	7/32" TO 5/8" (5.6 TO 16MM) I.D.	\$2.25	\$ 4.00
7-0003	7/16" TO 25/32" (11 TO 20MM) I.D.	2.30	4.25
7-0004	1/2" TO 29/32" (13 TO 23MM) I.D.	2.35	4.50
7-0005	9/16" TO 1 1/16" (14 TO 27MM) I.D.	2.40	4.75
	STANDARD WIDTH (1/2" WIDE)		
7-0006	1/2" TO 29/32" (13 TO 23MM) I.D.	3.00	5.50
7-0007	9/16" TO 1 1/16" (14 TO 27MM) I.D.	3.05	5.75
7-0015	11/16" TO 1 1/4" (17.5 TO 32MM) I.D.	3.10	6.00
7-0008	13/16" TO 1 1/2" (21 TO 38MM) I.D.	3.15	6.80
7-0010	1 1/16" TO 2" (27 TO 51MM) I.D.	3.20	7.25
7-0002	1 5/16" TO 2 1/4" (33 TO 57MM) I.D.	3.25	7.75
7-0011	1 9/16" TO 2 1/2" (40 TO 64MM) I.D.	3.50	8.25
7-0009	1 13/16" TO 2 3/4" (46 TO 70MM) I.D.	4.35	9.25
7-0012	2 1/16" TO 3" (52 TO 76MM) I.D.	4.50	9.75
7-0013	2 9/16" TO 3 1/2" (65 TO 89MM) I.D.	4.90	10.50
7-0014	2 13/16" TO 3 3/4" (71 TO 95MM) I.D.	5.00	11.00
7-0016	3 1/16" TO 4" (78 TO 102MM) I.D.	5.10	11.75
7-0017	3 9/16" TO 4 1/2" (91 TO 114MM) I.D.	5.25	12.50
7-0018	4 1/8" TO 5" (105 TO 127MM) I.D.	5.35	13.25
7-0019	4 5/8" TO 5 1/2" (117 TO 140MM) I.D.	5.50	13.75
7-0020	5 1/8" TO 6" (130 TO 152MM) I.D.	5.90	14.25
7-0021	5 5/8" TO 8 1/2" (142 TO 215MM) I.D.	7.50	
	- HOSE CLAMP SETS -	PLAIN	POLISHED
7-0040	V-8 SET - FUEL LINE, RADIATOR & HEATER HOSES (10 PC.)	25.50	57.50
7-0041	VW SET - FOR BUGS, BUSES AND GHIAS (10 PIECES)	25.50	57.50

**- FOR POLISHED HOSE CLAMPS ADD
A "P" TO THE PART NUMBER -**

SNAP FASTENERS

- GREAT FOR CONVERTIBLE TOPS, BOAT TARPS, ETC. -



CAP # 2-6000 \$.29 EACH



SOCKET # 2-6001 \$.29 EACH



STUD # 2-6002 \$.13 EACH



POST # 2-6003 \$.13 EACH

- USE WITH #8 JACKSON
OVAL HEAD SCREWS

E-STYLE RETAINING RINGS

15-7 PH - MO STAINLESS

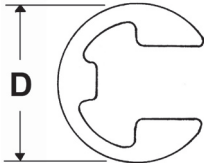

SIZE	D	T	GROOVE WIDTH	GROOVE DIAMETER	PART#	\$
3/16	.335	.025	.029	.147	2-5903	.39
1/4	.527	.025	.029	.210	2-5905	.48
5/16	.50	.025	.029	.250	2-5906	.48
3/8	.66	.035	.039	.303	2-5907	.76

WIRE ROPE (CABLE) & SLEEVES

302 SS - 19 STRAND (GOOD FLEXIBILITY)

SIZE	PART#	\$/FT	BREAKING STRENGTH	PART# (SLEEVE)	\$
1/32	7-3000	.39	185 LB	7-3010	1.90
1/16	7-3002	.63	500 LB	7-3012	1.90
3/32	7-3004	.78	1200 LB	7-3013	1.90
1/8	7-3005	.97	2100 LB	7-3014	2.90

DOME HEAD OPEN ENDED TUBULAR RIVETS

- 100% 300 SERIES STAINLESS STEEL RIVETS - MADE IN USA -

GRIP RANGE	1/8" DIA.		5/32" DIA.		3/16" DIA.	
	PART#	\$	PART#	\$	PART#	\$
0 - 1/8"	2-4801	.19			2-4806	.29
1/8 - 1/4"	2-4803	.21	2-4805	.27	2-4800	.34
1/4 - 3/8"	2-4802	.25			2-4807	.36
3/8 - 1/2"	2-4804	.27			2-4808	.39



LAG BOLTS

GREAT FOR MARINE USE OR
BUILDING THE PERFECT DECK!

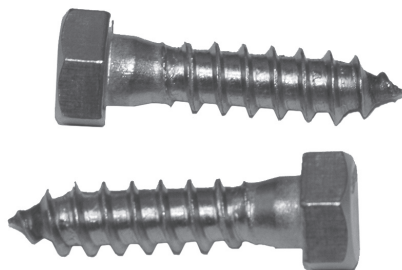

SIZE:	1/4		5/16		3/8		1/2	
LENGTH	PART#	\$	PART#	\$	PART#	\$	PART#	\$
1	2-1830	.33	2-1810	.39	2-1820	.59		
1 1/4	2-1831	.35	2-1811	.41	2-1821	.61		
1 1/2	2-1803	.38	2-1812	.43	2-1822	.63	2-9839	1.26
1 3/4	2-9816	.39	2-9819	.45				
2	2-1804	.42	2-1813	.47	2-1823	.67	2-1843	1.39
2 1/2	2-1832	.49	2-1842	.49	2-1824	.69	2-9840	1.55
2 3/4					2-9829	.89		
3	2-1833	.55	2-1841	.59	2-1825	.98	2-1836	1.69
3 1/2	2-1807	.67	2-1814	.99	2-1826	1.20	2-1837	1.86
4	2-1834	.77	2-1815	1.22	2-1827	1.25	2-1838	1.98
4 1/2	2-9817	.82	2-9826	1.33	2-9830	1.34	2-9841	2.46
5	2-1849	.87	2-1816	1.46	2-1828	1.43	2-9842	2.90
5 1/2	2-9818	.93	2-9828	1.57	2-9832	1.69	2-9843	3.27
6	2-1840	.98	2-1835	1.68	2-1829	1.98	2-9844	3.60
8					2-9831	9.80	2-9846	15.95

CLEVIS & COTTER PINS

HAIRPIN COTTERS

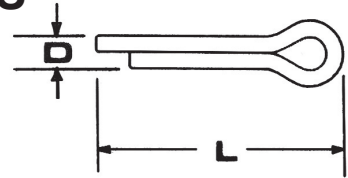

PART NUMBER AND PRICE GUIDE

D	L	FOR SHAFT SIZES	EYE ID	PART#	\$
.042	1	3/16 - 1/4	1/4	2-5050	.25
.062	13/16	1/4 - 3/8	5/16	2-5051	.29
.073	1 7/8	3/8 - 1/2	5/8	2-5052	.37
.092	2	3/8 - 5/8	5/8	2-5053	.59
.125	2 9/16	7/16 - 3/4	9/16	2-5054	.97

SIZE:	3/64		1/16		3/32		1/8	
LENGTH	PART#	\$	PART#	\$	PART#	\$	PART#	\$
3/8			2-5019	.04				
1/2	2-5040	.05	2-5000	.05	2-5006	.06	2-5012	.09
5/8	2-5041	.06	2-5047	.05	2-5081	.07	2-5084	.10
3/4	2-5042	.06	2-5001	.05	2-5007	.07	2-5013	.11
1	2-5043	.06	2-5002	.06	2-5008	.08	2-5014	.13
1 1/4	2-5044	.07	2-5003	.06	2-5009	.09	2-5015	.15
1 1/2	2-5045	.07	2-5004	.07	2-5010	.10	2-5016	.16
1 3/4			2-5048	.08	2-5082	.10	2-5085	.17
2	2-5046	.09	2-5005	.09	2-5011	.11	2-5017	.18
2 1/2					2-5083	.15		
3							2-5018	.21

SMALL EYE I.D. COTTER PINS					
D	L	FOR SHAFT SIZES	EYE ID	PART#	\$
.047	19/32	1/8-3/16	1/8	2-5070	.23
.054	3/4	3/16-1/4	1/8	2-5071	.34
.080	1 3/16	1/4-3/8	1/4	2-5072	.43
.093	1 5/8	1/4-1/2	3/8	2-5073	.55

SIZE:	5/32		3/16		1/4	
LENGTH	PART#	\$	PART#	\$	PART#	\$
3/4	2-5020	.16	2-5026	.25		
1	2-5021	.18	2-5027	.27	2-5033	.39
1 1/4	2-5022	.20	2-5028	.29	2-5034	.45
1 1/2	2-5023	.21	2-5029	.34	2-5035	.49
1 3/4	2-5086	.23	2-5089	.37	2-5038	.50
2	2-5024	.25	2-5030	.39	2-5036	.53
2 1/2			2-5090	.42		
3	2-5025	.29	2-5031	.45	2-5037	.68
4	2-5088	.49	2-5032	.68		

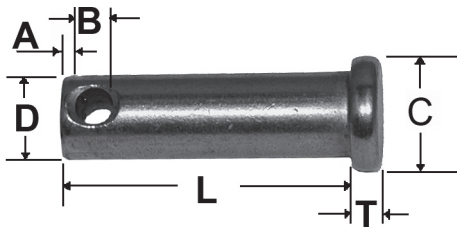

DIMENSION TABLE (INCHES)

D	DIAMETER	1/4	5/16	3/8	1/2
A	END TO HOLE	.14	.21	.23	.23
B	HOLE SIZE	3/32	5/32	5/32	5/32
C	HEAD DIAMETER	3/8	7/16	1/2	5/8
T	HEAD THICKNESS	.09	.09	.12	.15
	SHEAR STRENGTH -LBS	1,500	2,500	3,700	6,500

PERSONAL ASSORTMENT: 1000 PIECES 18 SIZES
 1/16 X 1/2 THROUGH 3/16 X 1 1/2 3-3140 78.00
 SHOP ASSORTMENT: 2175 PIECES 24 SIZES:
 1/16 X 1/2 THROUGH 1/4 X 1 1/4 3-3038 199.00

HAIRPIN CLIPS

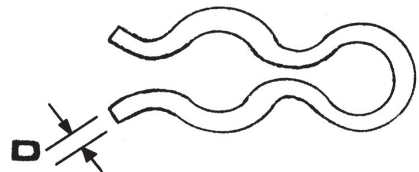

L: LENGTH PART NUMBER AND PRICE GUIDE

SIZE:	1/4		5/16		3/8		1/2	
L	PART#	\$	PART#	\$	PART#	\$	PART#	\$
3/4	2-9003	1.30	2-9022	2.40	2-9041	3.55		
1	2-9005	1.40	2-9024	2.50	2-9043	3.70	2-9076	6.30
1 1/4	2-9006	1.50	2-9025	2.60			2-9077	6.45
1 1/2	2-9007	1.60	2-9026	2.70	2-9045	4.10	2-9078	6.60
1 3/4	2-9008	1.75	2-9027	2.80	2-9046	4.45	2-9079	6.75
2	2-9009	1.90	2-9028	2.90	2-9047	4.80	2-9080	6.90
2 1/4			2-9031	3.20	2-9050	4.98		
2 1/2			2-9032	3.40	2-9051	5.34		

D	SHAFT SIZE	GROOVE DIA.	PART#	\$
.029	1/8	5/64	2-5059	.19
.031	3/16	9/64	2-5060	.19
.048	5/16	1/4	2-5062	.26
.052	3/8	5/16	2-5063	.29
.055	7/16	3/8	2-5064	.34
.064	1/2	7/16	2-5065	.59
.087	5/8	17/32	2-5066	.89
.093	3/4	21/32	2-5067	.98

POLISHING SUPPLIES - ALL MADE IN USA

- BASIC POLISHING KITS** - 6" SEWN & LOOSE BUFFS AND (2) 1 LB. BARS (1) OF EACH COMPOUND # 3-2000 \$ 65.75
 6" SEWN & LOOSE BUFFS AND (2) 1 LB. BARS OF WHITE COMPOUND 3-2003 66.50
 8" SEWN & LOOSE BUFFS AND (3) 1 LB. BARS OF COMPOUND 3-2001 83.50
 (2) BARS OF WHITE COMPOUND & (1) OF GRAY COMPOUND

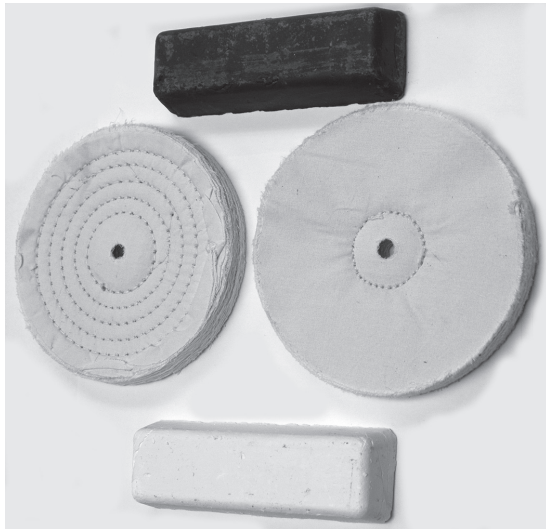

INDIVIDUAL COMPONENTS:

- GRAY COMPOUND (CUTTING)**
 1 LB. BAR # 3-2020 \$11.50
 3 LB. BAR 3-2023 21.50
WHITE COMPOUND (COLORING)
 1 LB. BAR 3-2021 12.75
 3 LB. BAR 3-2024 22.75
SEWN BUFFS - 3/4" THICK
 6" DIAMETER 3-2010 19.75
 8" DIAMETER 3-2012 24.75
LOOSE BUFFS - 1" THICK
 6" DIAMETER 3-2011 19.75
 8" DIAMETER 3-2013 24.75

THESE ARE THE BEST BUFFS WE'VE FOUND & WE'VE USED A LOT OF BUFFS! THEY LAST LONGER AND ARE LESS PRONE TO THROWING OFF LOOSE STRINGS.

- U.S. FASTENER HOLDER SET # 3-2050 \$ 85.75**
 - SET CONTAINS 4 TOOLS: A TAPERED TOOL FOR WASHERS, 3 TOOLS (1/4-20, 5/16-18, & 3/8-16) FOR HOLDING NUTS AND BOLTS. THIS SET IS ALL THAT IS NEEDED FOR A TYPICAL U.S. ENGINE KIT.
 ** NOTE: FOR SAFETY, FASTENERS HOLDERS ARE A MUST!
METRIC FASTENER HOLDER SET # 3-2049 \$ 87.00
 -SET CONTAINS 4 TOOLS: A TAPERED TOOL FOR WASHERS, 3 TOOLS (6MM, 8MM, & 10MM) FOR HOLDING NUTS AND BOLTS

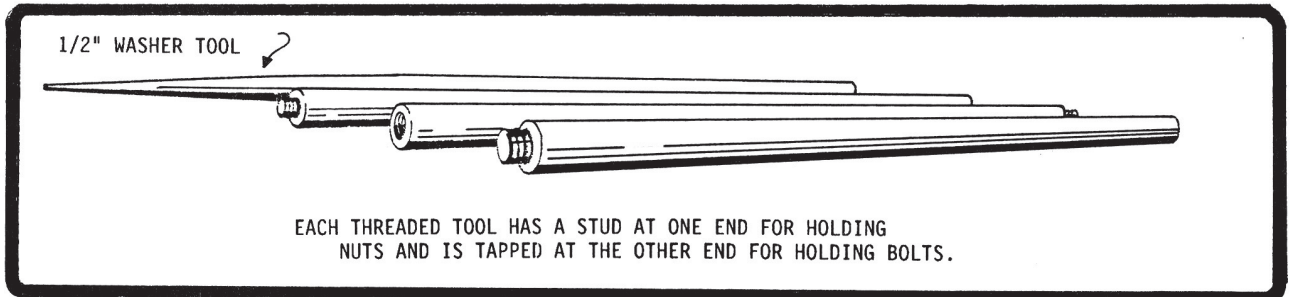

- INDIVIDUAL TOOLS:**
 - WASHER TOOLS: 1/2" DIAMETER # 3-2069 \$ 21.75 3/4" DIAMETER # 3-2070 \$ 32.75
THREADED TOOLS:

- COARSE THREAD -			- FINE THREAD -			- METRIC THREAD -		
SIZE	PART#	\$	SIZE	PART#	\$	SIZE	PART#	\$
6-32	3-2054	19.75				3-0.5	3-2063	20.50
8-32	3-2055	19.75				4-0.7	3-2064	20.50
10-24	3-2056	19.75	10-32	3-2071	19.75	5-0.8	3-2065	22.00
1/4-20	3-2052	21.50	1/4-28	3-2057	21.50	6-1.00	3-2066	22.00
5/16-18	3-2051	22.50	5/16-24	3-2058	22.50	8-1.25	3-2067	22.00
3/8-16	3-2053	23.00	3/8-24	3-2059	23.00	10-1.5	3-2068	23.50
7/16-14	3-2060	25.00	7/16-20	3-2072	25.00	12-1.75	3-2073	25.50
1/2-13	3-2061	26.00	1/2-20	3-2062	26.00			



- GRIT FLAP WHEELS**
 -IDEAL FOR TAKING OFF DEEP SCRATCHES AND MANUFACTURING MARKS. 320 GRIT FLAP WHEELS PRODUCE A SMOOTH FINISH - READY FOR BUFFING. WHEELS WITH COARSER GRIT (180,120, ETC.) PRODUCE SCRATCHES THAT BUFFS AND COMPOUND CAN'T REMOVE. FLAP WHEELS NORMALLY OUTLAST BUFFING WHEELS BY 4 TIMES.
320 GRIT ABRASIVE FLAP WHEELS
 6" DIA. X 1" WIDE # 3-2100 \$ 50.00
 8" DIX. X 1" WIDE 3-2101 85.00

- MASTER POLISHING KIT: INCLUDES POLISHING KIT, FLAP WHEEL, & U.S. FASTENER HOLDER SET**
 - 6" WHEELS # 3-2006 \$ 210.00
 - 8" WHEELS 3-2008 270.00

POINT OF PURCHASE DISPLAYS



**20 PACKS OF TOTAL-LOC HEADER BOLTS
(10) OF BOTH 12 & 16 COUNT
8-0001**



EXAMPLE OF A PIPE PLUG PACKAGE



STANDING DISPLAY

**4 SIDED ISLAND WITH 250
\$10 PACKAGES OF:**

- BUTTON HEAD,
 - HOSE CLAMPS,
 - PHILLIPS PAN,
 - PHILLIPS OVAL,
 - CARRIAGE,
 - TRUSS HEAD,
 - NUTS,
 - LOCK NUTS,
 - LOCK WASHERS,
 - & WASHERS
- # 8-0400

**WE MAKE 100'S OF UNIQUE PACKS
OF STAINLESS PRODUCTS**

**CALL 1-800-767-4781 OR
1-717-677-8811 OUTSIDE USA
FOR PRICING**



1945 HEIDLEBURG RD
 ASPERS, PA 17304
 1-800-767-4781
 717-677-8811
 FAX: 717-677-4525



CUSTOMER ID#		[] HOME [] BUSINESS		*PLEASE CHECK APPROPRIATE BOX*		[] HOME [] BUSINESS		46			
NAME:				NAME:							
SHIPPING ADDRESS:				MAILING / BILLING ADDRESS:							
CITY		STATE		ZIP		CITY		STATE		ZIP	
PHONE (DAY):				PHONE (EVENING):							
MAKE OF VEHICLE			MODEL			YEAR		ENGINE SIZE			
BILLING ADDRESS		[] SAME AS SHIPPING ADDRESS		*PLEASE CHECK APPROPRIATE BOX*		[] SAME AS MAILING ADDRESS					

QTY	PART #	DESCRIPTION	PG #	EACH	TOTAL
* MINIMUM FOR EACH ITEM IS \$1.95 RETAIL OR \$3.95 WHOLESALE *					
1					
2					
3					
4					
5					
6					
7					
8					
9					
10					
11					
12					
13					
14					
15					
16					
17					
18					
19					
20					
21					
22					
23					

* * WHEN PURCHASING ANY 7/16(10MM) OR LARGER LOW STRENGTH BOLTS, STATE THE APPLICATION! *

NOTE: MINIMUM ORDER FOR RETAIL IS \$19.95, WHOLESALE IS \$39.95		TOTAL:
CREDIT CARD# _____	SECURITY CODE _____	SHIPPING/HANDLING:
EXP _____		COD CHARGE \$20.00:
CARDHOLDER'S SIGNATURE _____		SALES TAX: 6% PA RESIDENTS ONLY:
		TOTAL DUE:

SHIPPING/HANDLING: \$19.95-69: \$9.95 \$70-109: \$10.95 \$110-129: \$11.95 \$130-149: \$12.95
 \$150-169: \$13.95 \$170-189: \$14.95 \$190-209: \$15.95 \$210-229: \$16.95 \$230-249: \$17.95 \$250-299: \$18.95 \$300-399: \$19.95
 \$400-499: \$21.95 \$500-599: \$23.95 \$600-699: \$25.95 \$700-799: \$27.95 \$800-899: \$29.95 \$900-999: \$31.95 \$1000 UP: \$33.95
 -SHIPMENTS OUTSIDE THE CONTINENTAL U.S. CAN BE SENT BY PRIORITY MAIL OR UPS - SHIPPING IS \$5 PLUS POSTAGE -
 NOTE: UPS NEXT, 2ND, & 3RD DAY AND SATURDAY DELIVERY IS AVAILABLE AT COST PLUS \$5